

No.	Data	Modification description	Version
1	Aug.2021	Initial version	V1.0
2	Dec.2022		
...			

Quick Contents

How to Set Parameters in a Convenient Way

Only choose the purpose of fan, pump, or conveyor belt, etc., to automatically set the best parameters.

⇒ [4.7 Automatic Setting of Parameters for Specific Purpose](#) (Page 38)

How to Carry out Motor Auto-tuning

When the motor is running, the related parameters of the motor are automatically learned and set.

⇒ [4.8 Auto-tuning](#) (Page 38)

How to Diagnosis a Fault

When a warning or fault is displayed on the keypad

⇒ [6.2 Types of Faults, Warnings and Notice Codes](#) (Page 56)

When no alarm or fault is displayed on the keypad

⇒ [6.7 Troubleshooting without Notices on the keypad](#) (Page 77)

Contents

Quick Contents	II
Contents	III
1 Preface and Cautions	1
1.1 Before Use	1
1.2 Instructions for Safe Use	1
1.3 Instructions for Special Purpose	3
2 Before Use	4
2.1 Safety Cautions	4
2.2 Drive Model and Nameplate	4
2.3 Technical Specifications of Drive	5
2.4 The Relationship between the Rated Output Current, Voltage Level and Power of the Drive	7
2.5 Default Acceleration and Deceleration Time of the Drive	8
2.6 Default Voltage Protection Point of the Drive	9
2.7 Carrier Frequency of Drive	9
2.8 Types and Characteristics of Control Modes	9
3 Installation and Wiring	11
3.1 Safety Cautions	11
3.2 Installation Environment	11
3.3 Installation Direction and Space	13
3.4 Dimensions	13
3.4.1 Dimensions of drive (Plastic)	13
3.4.2 Dimensions of Drive (Steel shell)	15
3.4.3 Dimensions of Drive (Cabinet)	17
3.4.4 Keypad dimensions	18
3.5 Standard Wiring	19
3.5.1 Standard connection diagram	20
3.5.2 Auxiliary terminal output capacity	20
3.5.3 Illustration and description of DIP switch function	21
3.5.4 Multi-function input point connection	21
3.5.5 Connection diagram of jumper caps "+24V", "PLC", "COM"	22
3.6 Wiring of Main Circuit	22
3.6.1 Arrangement and definition of terminals	22
3.6.2 Main circuit wiring of three-phase 380 V drive	23
3.6.3 Main circuit wiring of Single/Three-phase 220 V drive	24
3.6.4 Recommended main circuit components specification	24
3.7 Wiring of Control Circuit	25
3.7.1 Arrangement of control circuit terminals	25
3.7.2 Wiring specifications of control circuit terminals	26
3.8 Braking Resistor Settings	26
3.9 Backup Control System	30
4 Initial Start and Test-run	31
4.1 Safety Cautions	31
4.2 Name and Function of Each Part of the Keypad	31
4.3 LED Status Indicator Lights	33
4.4 Keypad Operation	33
4.5 Items to Be Confirmed at Initial Start	34
4.6 Initial Start Steps	34
4.7 Automatic Setting of Parameters for Specific Purpose (Purpose Selection)	38
4.8 Auto-tuning	38
4.9 Test-Run	40
4.9.1 No-load test-run	40
4.9.2 No-load test-run	40
4.9.3 Test-run with load	41
4.10 Precise Adjustment during Test-run (Optimization of Control Performance)	41
4.11 Test-run Checklist	46
5 Network Communication	48

5.1 Safety Precautions	48
5.2 Modbus Communication	48
5.2.1 Master/Slave configuration	48
5.2.2 Communication rules	48
5.2.3 Information format	48
5.2.4 Communication command examples	49
5.2.5 Communication data list	52
5.2.6 Error code	55
6 Troubleshooting	56
6.1 Safety Precautions	56
6.2 Types of Faults, Warnings, Prompt Codes	56
6.3 List of Faults, Warnings, Prompt Codes	57
6.4 Faults	59
6.5 Warning	73
6.6 Fault Reset Method	76
6.7 Troubleshooting without Prompts on The Keypad	77
6.8 Self-learning fault sub-code description	79
7 Inspection and Maintenance	80
7.1 Safety Precautions	80
7.2 Inspection	81
7.3 Maintenance	83
7.4 Replacing the Cooling Fan	83
7.5 Replacing the Drive	83
7.6 Storage Instructions	84
8 End-Of-Life Disposal	85
8.1 Safety Precautions	85
8.2 Disposal Related Precautions	86
9 External Equipment and Options	87
9.1 Safety Precautions	87
9.2 External Equipment	87
9.3 Use of External Equipment	89
9.4 Installation and Wiring of Option Cards	92
9.4.1 AC300CAN1 communication card	94
9.4.2 AC300IO1 extension card	94
9.4.3 AC300DP01 card	95
9.4.4 AC300PG01 extension card	96
9.4.5 AC300RT1 resolver PG feedback card	96
10 Parameter List	98
10.1 Safety Precautions	98
10.2 Parameter List Reading Instructions	98
10.3 Parameter Groups	98
10.3.1 Parameter Types of the Drive	98
10.3.2 Parameter attributes of the drive	100
10.4 Group F00: Environmental Application	100
Group F00.0x: Environment Settings	100
Group F00.1x: Common Parameter Settings	101
10.5 Group F01: Basic Settings	102
Group F01.0x: Basic Commands	102
Group F01.1x: Frequency Command	103
Group F01.2x~F01.3x: Acceleration/Deceleration Time	104
Group F01.4x: PWM Control	105
10.6 Group F02: Motor 1 Parameters	106
Group F02.0x: Basic Motor Parameters and Auto-tuning Selection	106
Group F02.1x: Advanced Parameters of Asynchronous Motor	107
Group F02.2x: Advanced Parameters of Synchronous Motor	107
Group F02.3x~F02.4x: Encoder Parameters	108
Group F02.5x: Motor Application Parameters	109
10.7 Group F03: Vector Control	110
Group F03.0x: Speed Loop	110
Group F03.1x: Current Loop and Torque Limit	110
Group F03.2x: Torque Optimization Control	111
Group F03.3x: Flux Optimization	112

Group F03.4x~F03.5x: Torque Control	113
Group F03.6x: PM High-frequency Injection	115
Group F03.7x: Position Compensation	115
Group F03.8x: Extension Control	115
10.8 Group F04: V/F Control	115
Group F04.0x: V/F Control	115
Group F04.1x: Custom V/F Curve	117
Group F04.2x: V/F Separation Control	117
Group F04.3x: V/F Energy-Saving Control	118
10.9 Group F05: Input Terminals	119
Group F05.0x: Functions of Digital Input Terminals (X1-X10)	119
Group F05.1x: X1-X5 Detection Delay	120
Group F05.2x: Digital Input Terminal Action Selection	121
Group F05.3x: PUL Terminal	122
Group F05.4x: Analog Input (AI) Type Processing	122
Group F05.5x: Analog Input (AI) Linear Processing	123
Group F05.6x: AI Curve 1 Processing	123
Group F05.7x: AI Curve 2 Processing	124
Group F05.8x: AI as Digital Input Terminals	125
10.10 Group F06: Output Terminals	125
Group F06.0x: AO Output (Analog, Frequency)	125
Group F06.1x: Extended AO Output	127
Group F06.2x~F06.3x: Digital and Relay Output	127
Group F06.4x: Frequency Detection	128
Group F06.5x: Monitoring Parameter Comparator Output	128
Group F06.6x~Group F06.7x: Virtual Input and Output Terminals	130
10.11 Group F07: Running Control	131
Group F07.0x: Start Control	131
Group F07.1x: Stop and Zero-Frequency Control	132
Group F07.2x: DC Braking and Speed Tracking	133
Group F07.3x: Jogging	133
Group F07.4x: Start and Stop Frequency Retention and Frequency Hopping	134
10.12 Group F08: Auxiliary Control	134
Group F08.0x: Counting and Timing	134
Group F08.3x: Swing Frequency Control	135
10.13 Group F09: Auxiliary Control 2	136
Group F09.0x: Maintenance Functions	136
10.14 Group F10: Protection Parameters	136
Group F10.0x: Current Protection	136
Group F10.1x: Voltage Protection	137
Group F10.2x: Auxiliary Protection	138
Group F10.3x: Load Protection	140
Group F10.4x: Stall Protection	140
Group F10.5x: Fault Recovery and Motor Overload	141
10.15 Group F11: Keypad Parameters	142
Group F11.0x: Button Operation	142
Group F11.1x: Status Interface Cyclic Monitoring	143
Group F11.2x: Monitoring Parameter Control	145
Group F11.3x: Special Keypad Functions	146
10.16 Group F12: Communication Parameters	146
Group F12.0x: Modbus Communication Slave Parameters	146
Group F12.1x: Modbus Master Parameters	147
Group F12.2x: Special Modbus Functions	148
Group F12.3x: PROFIBUS-DP Communication	149
Group F12.4x: CAN Communication	149
Group F12.5x~Group F12.6x: extension Port EX-A and EX-B Communication	150
10.17 Group F13: Process PID Control	152
F13.00~F13.06: PID Setting and Feedback	152
F13.07~F13.24: PID Adjustment	153
F13.25~F13.28: PID Feedback Disconnection Judgment	155
F13.29~F13.33: Sleep Function	155
10.18 Group F14: Multi-Speed and Simple PLC	156

F14.00~F14.14: Multi-Speed Frequency Setting	156
F14.15: PLC Running Mode Selection	158
F14.16~F14.30: PLC Running Time Selection	158
F14.31~F14.45: PLC Direction and Acceleration/Deceleration Time Selection	159
10.19 Group F15: Reserved	160
10.20 Group F16: Tension Control	160
F16.03 - F16.09: Tension Setting	161
F16.12~F16.16: Friction Compensation	161
F16.30~F16.32: Material Interruption Detection	163
F16.36~F16.38: Pre-drive	163
F16.42~F16.43: Stop and Brake Hold	163
F16.44~F16.55: Roll Diameter Parameter Setting	164
F16.56~F16.63: Roll Diameter Calculation with Linear Velocity	164
F16.68~F16.70: Roll Diameter Calculation with Thickness	165
6.82: Tension PID	165
10.21 Group F17: Reserved	166
10.22 Group F18: Reserved	166
10.23 Group F19: User Programmable Group A	166
10.24 Group F20: User Programmable Group B	166
10.25 Group F21: Industry Application Extension Group	166
10.26 Group F22: Reserved	166
10.27 Group F23: Reserved	166
10.28 Group F24: Reserved	166
10.29 F25 group: AI and AO Correction	166
F25.00~F25.11: AI1 Correction	166
F25.12~F25.23: AI2 Correction	167
F25.24~F25.35: AO Correction	168
10.30 Group C0x: Monitoring Parameters	169
Group C00.xx: Basic Monitoring	169
Group C01.xx: Fault Monitoring	171
Group C02.xx: Application Monitoring	172
Group C03.xx: Maintenance and Tension Control Monitoring	174
Group C04.xx: Industry Application Monitoring	175
Group C05.xx: Control Monitoring	175
Group C06.xx: EX-A Monitoring	175
Group C07.0x: EX-B Monitoring	175
10.31 Communication Variable Group	175
Modbus Communication Control Group (Address 0x30xx/0x20xx)	175
Option Card Communication Control Group (Address 0x31xx)	178
Input/Output Interface Communication Group (Address 0x34xx)	179
Cache Register Communication Group (Address 0x35xx)	181
Extension Fault and Power-Off Parameter Communication Group (Address 0x36xx)	182
11 Parameter Details	184
11.1 Safety Precautions	184
11.2 Group F00: Environmental Application	184
Group F00.0x: Environment Settings	184
Group F00.1x: Common Parameter Settings	188
11.3 Group F01: Basic Settings	188
Group F01.0x: Basic Commands	188
Group F01.1x: Upper and Lower Frequency Limits	195
Group F01.2x~F01.3x: Acceleration/Deceleration Time	196
Group F01.4x: PWM Control	202
11.4 Group F02: Motor 1 Parameters	204
Group F02.0x: Basic Motor Parameters and Auto-tuning Selection	204
Group F02.1x: Advanced Parameters of Asynchronous Motor	206
Group F02.2x: Advanced Parameters of Synchronous Motor	207
Group F02.3x - F02.4x: Encoder Parameters	210
Group F02.5x: Motor Application Parameters	212
11.5 Group F03: Vector Control	214
Group F03.0x: Speed Loop (ASR)	214
Group F03.1x: Current Loop and Torque Limit	217
Group F03.2x: Torque Optimization Control	220

Group F03.3x: Flux Optimization	221
Group F03.4x~F03.5x: Torque Control	224
Group F03.6x: PM High-Frequency Injection	228
Group F03.7x: Position Compensation	229
Group F03.8x: Extension Control	229
11.6 Group F04: V/F Control	230
Group F04.0x: V/F Control	230
Group F04.1x: Custom V/F Curve	233
Group F04.2x: V/F separation Control	235
Group F04.3x: V/F Energy-Saving Control	237
11.7 Group F05: Input Terminals	238
Group F05.0x: Digital Input Terminals (X1 - X10)	238
Group F05.1x: Terminals X1~X5 Detection Delay	246
Group F05.2x: Digital Input Terminal Action Selection	248
Group F05.3x: Pulse Frequency Input (PUL) Terminal	252
Group F05.4x: Analog input (AI) Characteristic Selection	254
Group F05.5x: AI Linear Processing	255
Group F05.6x: AI Curve 1 Processing	257
Group F05.7x: AI Curve 2 Processing	259
Group F05.8x: AI as Digital Input Terminals	259
11.8 Group F06: Output Terminals	261
Group F06.0x: Analog Output (AO) Frequency	261
Group F06.1x: Expanded AO	264
Group F06.2x~F06.3x: Multi-functional Output Terminals	265
Group F06.4x: Frequency Detection	270
Group F06.5x: Monitoring Parameter Comparator Output	272
Group F06.6x: Virtual Input and Output Terminals	274
11.9 Group F07: Running Control	278
Group F07.0x: Start Control	278
Group F07.1x: Stop and Zero-Frequency Control	281
Group F07.2x: DC Braking and Speed Tracking	284
Group F07.3x: Jogging	287
Group F07.4x: Start and Stop Frequency Retention and Frequency Hopping	288
11.10 Group F08: Auxiliary Control 1	289
Group F08.0x: Counting and Timing	289
Group F08.3x: Swing Frequency Control	293
11.11 Group F09: Auxiliary Control 2	295
Group F09.0x: Maintenance Functions	295
11.12 Group F10: Protection Parameters	295
Group F10.0x: Current Protection	295
Group F10.1x: Voltage Protection	297
Group F10.2x: Auxiliary Protection	301
Group F10.3x: Load Detection Protection	305
Group F10.4x: Stall Protection	306
Group F10.5x: Fault Recovery and Motor Overload	308
11.13 Group F11: Keypad Parameters	310
Group F11.0x: Button Operation	310
Group F11.1x: Status Interface Loop Monitoring	313
Group F11.2x: Monitoring Parameter Control	315
Group F11.3x: Special Keypad Functions	317
11.14 Group F12: Communication Parameters	318
Group F12.0x: Modbus Slave Parameters	318
Group F12.1x: Modbus Master Parameters	321
Group F12.2x: Special Modbus Functions	323
Group F12.3x: PROFIBUS-DP Communication	326
Group F12.4x: CAN Communication	326
Group F12.5x: Communication of Extension Ports EX-A and EX-B	328
11.15 Group F13: Process PID Control	330
F13.00~F13.06: PID Setting and Feedback	330
F13.07 - F13.24: PID Adjustment	333
F13.25~F13.28: PID Feedback Disconnection Judgment	338
F13.29 - F13.33: Sleep Function	339

- 11.16 Group F14: Multi-Speed and Simple PLC 340
 - F14.00 - F14.14: Multi-Speed Frequency Setting 340
 - F14.15: PLC Running Mode Selection 343
 - F14.16 - F14.30: PLC Running Time Selection 345
 - F14.31~F14.45: PLC Direction and Acceleration/Deceleration Time Selection 347
- 11.17 Group F15: Reserved 350
- 11.18 Group F16: Tension Control 350
 - F16.03~F16.09: Tension Setting 351
 - F16.12 ~ F16.16: Friction Compensation 354
 - F16.30~F16.32: Material Interruption Detection 355
 - F16.36~F16.38: Pre-drive 355
 - F16.42~F16.43: Stop and Brake Hold 356
 - F16.44~F16.55: Roll Diameter Parameter Setting 357
 - F16.56~F16.63: Roll Diameter Calculation with Linear Velocity 359
 - F16.68~F16.70: Roll Diameter Calculation with Thickness 361
 - F16.75~F16.82: Tension PID 362
- 11.19 Group F17: Reserved 364
- 11.20 Group F18: Reserved 364
- 11.21 Group F19: User Programmable Group A 364
- 11.22 Group F20: User Programmable Group B 364
- 11.23 Group F21: Industry Application extension Group 364
- 11.24 Group F22: Reserved 364
- 11.25 Group F23: Reserved 364
- 11.26 Group F24: Reserved 365
- 11.27 Group F25: Calibration of Analog Input and Output (AI, AO) 365
 - F25.00 ~ F25.11: AI1 Calibration Parameters 365
 - F25.12 ~ F25.23: AI2 Calibration Parameters 366
 - F25.24 - F25.35: AO Calibration Parameters 367

1 Preface and Cautions

1.1 Before Use

Terms and abbreviations related to this manual

Terms and abbreviations in this manual	Description
Drive	AC310
AM-VF	Asynchronous - VF Control
AM-FVC	Asynchronous - Vector Control without PG
AM-SVC	Asynchronous - Vector Control with PG
AM-VF-separation	Asynchronous - Voltage Frequency separation
PM-VF	Synchronous - VF Control
PM-FVC	Synchronous - Vector Control without PG
PM-SVC	Synchronous - Vector Control with PG
PG	Speed Feedback
Bit	Bits in binary digits

1.2 Instructions for Safe Use

Thank you for purchasing the AC310 series vector control drive designed and manufactured by Suzhou VEICHI Electric Co., Ltd. This manual describes how to use this product correctly for better revenue. Please read this manual carefully before using the product (installation, wiring, operation, maintenance, inspection, etc.). In addition, please fully understand the safety precautions described in this manual before using this product.

Safety Precautions

To ensure safe, reliable and reasonable use of this product, please use the product after fully understanding the safety precautions described in this manual.

Warning Signs and Indications

The following marks are used in this manual to indicate safety precautions. Failure to observe these precautions may result in personal injury or death, damage to the product and related systems.

Danger	Danger: False operation may cause death or a major safety accident.
Warning	Warning: False operation may cause death or a major safety accident.
Caution	Caution: False operation may cause minor injuries.
Notices	Notices: False operation may cause damage to the product and related systems.

General Cautions

In order to introduce the details of the product, the illustrations in this manual sometimes show the product with the outer cover or safety cover removed. When using this product, please be sure to install the outer cover or safety cover as required, and operate according to the regulations in this manual.

The figures in this manual are only representative examples, and may be different from the products you ordered.

Due to product improvements or specification changes, as well as to improve the convenience of the Manual itself, this Manual may be changed without notice.

If you need to purchase this manual due to damage or loss, please contact our agencies or our sales office closest to you as stated on the back cover herein, and inform of the material number on the cover.

Danger

Please follow all the safety instructions in this manual.

Failure to follow the precautions may result in death or serious injury. Please be cautious. We will not take any responsibility for personal injuries and equipment damages caused by your company or your customers due to not complying with the contents of this manual.

To prevent electric shock

Do not perform inspection or wiring work while the power is on. Before wiring or repairing, be sure to cut off the power of all drive. Even if the power is cut off, there is still residual voltage in the capacitor inside the drive. To prevent electric shock, wait at least the time specified by the warning label on the front panel of the product. After the indicators light is off completely, remove the front cover and terminal cover, and measure the input power voltage and the main circuit DC voltage to make sure the voltage is safe.

Warning

For mechanical safety

After the wiring work and parameter setting are completed, be sure to perform a test run to make sure that the drive can operate safely; otherwise it may cause personal injury or equipment damage.

Be sure to verify the set points of parameters for the virtual input/output function before the test run of drive.

The virtual input/output function is based on the virtual wiring of the input/output terminals inside the drive. Therefore, even if there is no physical wiring on the input/output terminals, the operation of the drive may be different from the factory settings. If lack of verification, unexpected actions of the drive may cause personal accidents.

Before powering on the drive, please make sure that there are no people around the drive, motor and machinery. In addition, please make sure that the cover, coupling, shaft and machinery of the drive are properly protected.

In some systems, the machinery may suddenly move when the main circuit is energized, which may cause death or serious injury.

With external terminal control of drive, the function of the input/output terminals of the drive will be different from the factory setting, so the action of the drive may be different from the action under the factory setting described in the manual. Before the test run of drive, please use external terminal control to confirm the input/output signals of the drive and the internal sequence control.

To prevent electric shock

It is strictly forbidden to modify the drive.

- We will not take any responsibility for the modification of the product by your company or your customers.
- Non-electrical professionals are not allowed to perform wiring, installation, maintenance, inspection, component replacement or repair operations.
- Do not remove the outer cover of the drive or touch the printed circuit board when the power is on.

To prevent fire

Ensure to use the correct voltage of the main circuit power supply. Before energizing, please confirm whether the rated voltage of the drive is consistent with the power supply voltage.

Please follow local standards to set up bypass protection circuits. Improper wiring may cause fire or personal accidents.

Caution

To prevent injury

Do not move the drive by holding the front cover or terminal cover of the drive. In addition, please make sure that the screws are properly tightened before move.

If you move the drive by holding the front cover or terminal cover, the drive may fall due to loose screws, which may cause injury.

Notices

Please use motors which meet the PWM drive insulation requirements, in order to prevent short-circuit due to insulation aging or grounding short-circuits.

When operating the drive or disassembling printed circuit boards, please follow the steps specified in the Electrostatic Discharge (**ESD**) protection measures. False operation may cause damage to the internal circuit of the drive due to static electricity.

No voltage withstand test can be carried out on any part of the drive. This drive is equipped with precision instruments which may be damaged due to high voltage.

Do not operate a damaged machine. If the machine is obviously damaged or has missing parts, please do not connect or operate it, otherwise it will aggravate the damage of the machine and cause additional problems.

When the fuse is blown or the leakage circuit breaker is tripped, do not immediately turn on the power or operate the drive. Please check whether the cable connection and the selection of external units are correct, and find out the cause of the problem. If you are unable to determine the cause, please contact our company and do not turn on the power or operate the drive without authorization.

When the packaging are wood materials need to be disinfected and dewormed process, methods other than fumigation must be used, such as heat treatment (over **30** minutes with the core temperature of **56°C**). In addition, please process the package materials before packaging, rather than processing the whole product after packaging.

When fumigated wooden materials are used to package electrical products (only drive or installed on machinery), the gas and vapor generated by the packaging materials may cause fatal damage to electronic products. In particular, halogen disinfectants (fluorine, chlorine, bromine, iodine, etc.) may cause corrosion to the inside of the capacitor, and DOP gas (phthalate) may cause cracks to the resin.

1.3 Instructions for Special Purpose

If you need to use this product for special purposes such as manned, medical, aerospace, nuclear energy, electric power, submarine relay communication equipment or systems, please consult our agents or sales persons in charge.

2 Before Use

2.1 Safety Cautions

Danger

Please follow all the safety instructions in this manual.

Failure to follow the precautions may result in death or serious injury. Please be cautious. We will not take any responsibility for personal injuries and equipment damages caused by your company or your customers due to not complying with the contents of this Manual.

2.2 Drive Model and Nameplate

After receiving the product, please confirm the following:

- Please check the appearance for scratches or dirt on the drive. If there is damage, please contact the transportation company immediately. Damage caused by product transportation is not covered by our warranty.
- Please confirm whether the model of the drive is consistent with the product you ordered. Please refer to the "MODEL" column on the nameplate on the side of the drive for the model.
- If any defect is found, please immediately contact our distributor or sales persons in charge from whom you purchased the product.

Nameplate

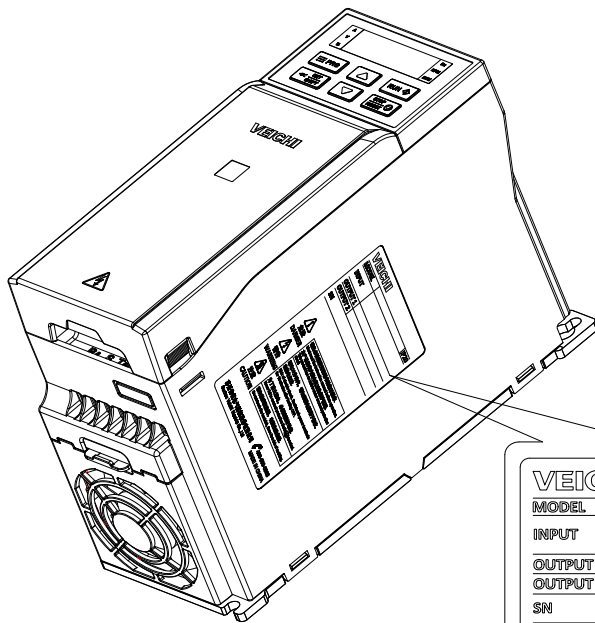

VEICHI	
MODEL	IP20
INPUT	
OUTPUT 1	
OUTPUT 2	
SN	

— Inverter model
 — Input specification
 — Output specifications 1
 — Output specifications 2
 — Production serial

⚠	危险 DANGER	请务必按照使用说明书的指示操作。 Must read the instruction manual before operation. 本产品没有内置电机过热保护回路。 This product has no built-in motor overheat protection circuit.
⚡	警告 WARNING	断电10分钟内，请勿触摸电源端子部位。 有触电危险。 Risk of electric shock. Don't touch power terminals for 10 minutes after turning OFF.
⚠	注意 CAUTION	为了防止触电，必须连接好地线。 Never fail to connect protective Earth terminal. 请勿触摸散热器，有烫伤的危险。 Do not touch the heatsink, there is a risk of scalding.

苏州伟创电气科技股份有限公司
 Suzhou Veichi Electric Co.,Ltd 400-600-0303
 MADE IN CHINA

Model reference

The method of checking the model of drive is shown in the figure below:

$$\frac{\text{AC310} - \text{T} \text{ 3} - \text{011G/015P} - \text{B}}{\begin{matrix} 1 & 23 & 4 & 5 & 6 \end{matrix}}$$

Parameter Code	Name
1	Drive series
2	Voltage Level T: Three-phase S: Single-phase
3	Voltage Level 2: 220V 3: 380V 6: 660V 11:1140V
4	Matching motor power (kW) 7R5G: 7.5 011G: 11 132G: 132
5	Drive type G: Heavy load P: Light load
6	Accessory type B: Braking unit L: DC reactor D: Cabinet units

2.3 Technical Specifications of Drive

Table 2-1: Technical Specifications

Item	Specification
Power input	Voltage and frequency S2: Single-phase 200 V-240 V 50/60 Hz. T2: Three-phase 200 V-240 V 50/60 Hz. T3: Three-phase 380 V-480 V 50/60 Hz. T6: Three-phase 660 V-690 V 50/60 Hz.
	Allowable fluctuation T/S2: -10%~10%; T3: -15%~10%; T6: -10%~10% Voltage imbalance rate: < 3%; Frequency: ±5%. Distortion rate meets IEC61800-2.
	Switching inrush current Less than rated current
	Power factor Power factor ≥0.94 (with DC reactor)
	Drive efficiency ≥96%
Output	Output voltage Output under rated conditions: Three-phase, 0 V to input voltage, inaccuracy less than 5%.
	Output frequency range G/P model: 0.00 Hz - 600.00 Hz.
	Output frequency accuracy ±0.5% of Max Freq.
	Overloading capability G model: 150% rated current for 89 s, 180% rated current for 10 s, and 200% rated current for 3 s. P model: 110% rated current for 105s 120% rated current for 35 s, 140% rated current for 7 s, and 150% rated current for 3 s.

Main control performance	Motor type	Asynchronous motor, synchronous motor, and synchronous reluctance motor
	Motor control mode	V/F control, open-loop vector control, closed-loop vector control, and VF separation control.
	Modulation mode	Optimized space vector PWM modulation.
	Carrier frequency	1.0kHz~16.0kHz
	Speed control range	Vector control without PG, rated load: 1:200. Vector control with PG, rated load: 1:1000.
	Steady-state speed accuracy	Vector control without PG: $\leq 0.5\%$ of rated synchronous speed (asynchronous), $\leq 0.1\%$ of rated synchronous speed (synchronous). Vector control with PG: $\leq 0.02\%$ of rated synchronous speed.
	Starting torque	Vector control without PG: 150% rated torque at 0.25 Hz. Vector control with PG: 200% rated torque at 0 Hz.
	Torque response	Vector control without PG: < 10 ms, vector control with PG: < 5 ms.
	Torque accuracy	Vector control without PG: $\pm 5\%$, vector control with PG: $\pm 2.5\%$.
	Frequency accuracy	Digital setting: Maximum frequency $\times \pm 0.01\%$; Analog setting: Maximum frequency $\times \pm 0.2\%$.
	Frequency resolution	Digital setting: 0.01 Hz; Analog setting: maximum frequency $\times \pm 0.05\%$.
	Torque compensation	Automatic torque compensation: 0.0% to 100.0%. Manual torque compensation: 0.0% to 30.0%.
	V/F curve	Four modes: linear torque characteristic curve, self-setting V/F curve, reduced torque characteristic curve (to the power of 1.1 to 2.0), and square V/F curve.
	Acceleration and deceleration curve	Two modes: linear acceleration and deceleration, S-Curve acceleration and deceleration. Four sets of acceleration and deceleration time; the time unit is 0.01 s, the longest is 650.00 s.
	Rated output voltage	With power supply voltage compensation, the motor rated voltage reaches 100%, which can be set in the range of 50% to 100% (the output cannot exceed the input voltage).
	Automatic voltage regulation	When the power grid voltage fluctuates, it can automatically keep the output voltage constant.
	Automatic energy-saving operation	Under V/F control mode, the output voltage is automatically optimized according to the load to realize energy-saving operation.
	Automatic current limiting	The current is automatically limited during operation to prevent trips caused by frequent over-current faults.
	Instantaneous power failure processing	In case of instantaneous power failure, uninterrupted operation can be realized through bus voltage control.
	Standard features	PID control, speed tracking and restart after power failure, hopping frequency, upper and lower frequency limit control, program operation, multi-speed, RS485 communication, analog output, and frequency pulse output.
Frequency setting channel	Keypad digital setting, analog voltage/current terminal AI1, analog voltage/current terminal AI2, pulse input PUL, communication setting and multi-channel terminal selection, main/auxiliary channel combination, and extension card can be switched in various ways.	
Feedback input channel	Analog voltage/current terminal AI1, analog voltage/current terminal AI2, communication setting, and pulse input PUL.	
Run command channel	Operation panel setting, external terminal setting, communication setting, and extension card setting.	
Input order signal	Start, stop, forward and reverse, jogging, multi-speed, free stop, reset, acceleration and deceleration time selection, frequency setting channel selection, and external fault alarm.	
External output signal	1 relay output, 1 collector output, 1 AO output (can be selected as 0 V - 10 V or 0 mA - 20 mA or 4 mA - 20 mA output, or frequency pulse output).	

Protection function		Overvoltage, undervoltage, current limit, overcurrent, overload, electronic thermal relay, overheating, overvoltage stall, data protection, fast protection, input and output phase loss protection.	
Keypad display	LED display	Single-line 5-digit digital tube display	1 drive status display
		Dual-line 5-digit digital tube display	2 drive status displays
	Parameter copy	The function code information of the drive can be uploaded and downloaded to realize fast parameter copying.	
	Status monitoring	All parameters of the monitoring parameter group such as output frequency, given frequency, output current, input voltage, output voltage, motor speed, PID feedback, PID given, module temperature, etc.	
	Failure alarm	Overvoltage, undervoltage, overcurrent, short circuit, phase loss, overload, overheating, fast speed, damaged data protection, current fault status, and fault history.	
Environment	Installation site	Altitude shall be lower than 1,000 m. If the altitude exceeds 1,000 m, it shall be derated by 1% for every 100 m increase; Be free of condensation, icing, rain, snow, hail, etc., with solar radiation less than 700 W/m ² and air pressure between 70 kPa - 106 kPa.	
	Temperature and humidity	-10°C - +50°C. It can be derated above 40°C, and the maximum temperature is 60°C (No-load operation). 5% RH - 95% RH (no condensation).	
	Vibration	5.9 m/s ² (0.6 G) at 9 Hz - 200 Hz.	
	Storage temperature	-30°C - +60°C.	
	Installation method	Wall-mounted or vertical cabinet type.	
	Protection level	IP20.	
	Pollution degree	II	
	Cooling method	Forced air cooling.	

2.4 The Relationship between the Rated Output Current, Voltage Level and Power of the Drive

Power (kW) Output Current (A) Input Voltage (V)	220	380	660	1140
	0.75	4	3	—
1.5	7	4	—	—
2.2	10	6	—	—
4	16	10	—	—
5.5	20	13	—	—
7.5	30	17	10	—
11	42	25	15	—
15	55	32	18	—
18.5	70	38	22	—
22	80	45	28	—
30	110	60	35	—
37	130	75	45	25
45	160	90	52	31
55	200	110	63	38

75	260	150	86	52
90	320	180	98	58
110	380	210	121	75
132	420	250	150	86
160	550	310	175	105
185	600	340	198	115
200	660	380	218	132
220	720	415	235	144
250	—	470	270	162
280	—	510	330	175
315	—	600	345	208
355	—	670	380	220
400	—	750	430	260
450	—	810	466	270
500	—	860	540	325
560	—	990	600	365
630	—	1200	690	400
710	—	1340	760	480
800	—	1500	860	
900	—	1620	932	
1000	—	1980	1080	

2.5 Default Acceleration and Deceleration Time of the Drive

The default acceleration and deceleration of the drive vary with the power level. See the table below for details.

Drive power rating (kW)	Default of acceleration and deceleration time (s)
0.4	6.00
0.75	6.00
1.5	6.00
2.2	6.00
3.0	6.00
4.0	6.00
5.5	6.00
7.5	6.00
11.0	6.00
15.0	6.00
18.5	6.00
22.0	12.00
30.0	12.00
37.0	12.00
45.0	18.00
55.0	18.00
75.0	24.00
90.0	30.00
110.0	36.00
160.0	48.00
185.0	54.00
200.0	60.00
220.0 and above	60.00

2.6 Default Voltage Protection Point of the Drive

The default voltage value of the drive includes voltage level, rated voltage, undervoltage suppression point, undervoltage point, overvoltage suppression point, overvoltage point and dynamic braking point, etc. See the table below for details.

Note: The units for the values in the table are all volts (V).

Voltage Grade	Rated Voltage	Undervoltage Suppression Point	Undervoltage Point	Overvoltage Suppression Point	Overvoltage Point	Dynamic Braking Point
220	311.1	240	190	370	400	360
380	537.4	430	320	750	820	740
660	933.2	700	560	1100	1180	1080
1140	1612	1200	1000	1900	2100	1870

2.7 Carrier Frequency of Drive

Default value:

Voltage Grade (V)	Default Carrier (kHz)	
220	Less than 11 kW	4.0
	11 kW - 45 kW	3.0
	Above 45 kW	2.0
380	Less than 11 kW	4.0
	11 kW - 45 kW	3.0
	Above 45 kW	2.0
660	2.0	
1140	2.0	

Note: The drive shall be derated under high carrier frequency conditions; the higher the carrier, the greater the derating.

2.8 Types and Characteristics of Control Modes

The drive can choose AM-V/F control (initial setting), AM - open-loop vector control, AM - closed-loop vector control, PM-V/F control, PM - open-loop vector control, PM - closed-loop vector control, and VF separation control.

◆ Asynchronous motor V/F control

- When the frequency (F) is variable, the ratio of the control frequency to the voltage (V) remains constant.
- This control mode is used for all variable speed controls that do not require fast response and precise speed control, as well as one drive for multiple motors. This mode is also used when the motor parameters are not clear or Auto-tuning cannot be performed.

◆ Asynchronous motor open-loop vector control

- The output current of the drive can be calculated through vector calculation, and divided into excitation current and torque current, to carry out frequency and voltage compensation, so that the motor current matching the load torque can flow to improve the low-speed torque. At the same time, the output frequency compensation (slip compensation) is implemented to make the actual rotation speed of the motor closer to the speed instruction value.
- This control mode is used for applications requiring high speed control accuracy. With high speed response and torque response, high torque can be output even under low-speed running. It is suitable for general high-performance control occasions, and one drive can only drive one motor.

◆ Asynchronous motor closed-loop vector control

- This control mode is used where high-precision speed control or torque control is required, and high-precision speed control is required even at zero speed.
- An encoder must be installed at the motor end, and the drive must be equipped with a PG card of the same type as the encoder. One drive can only drive one motor.

◆ Synchronous motor V/F control (PMV/F)

- When the frequency (F) is variable, the ratio of the control frequency to the voltage (V) remains constant.
- This control mode is used for all variable speed controls that do not require fast response and precise speed control. This

mode is also used when the motor parameters are not clear or Auto-tuning cannot be performed.

◆ **Synchronous motor open-loop vector control (PMSVC)**

- By combining with a PM (permanent magnet) motor that is more efficient than an induction motor, it is possible to achieve motor control with high speed control accuracy more efficiently. With no need for a speed detector such as PG, the rotation speed of the motor is estimated through the output voltage and output current of the drive. In addition, in order to maximize the efficiency of the motor and control the PM motor, the current is minimized when the load is applied.
- This control mode is used for applications that require precise speed control and torque limit functions.

◆ **Synchronous motor closed-loop vector control (PMFVC)**

- This control mode is used where high-precision speed control or torque control is required, and high-precision speed control is required even at zero speed.
- An encoder must be installed at the motor end, and the drive must be equipped with a PG card of the same type as the encoder. One drive can only drive one motor.

◆ **Voltage frequency separation control (VF_separation)**

- This control mode is used to control the output voltage and frequency separately.
- This function is valid only for T3 models with 7.5 kW and above, and T/S2 models with 5.5 kW and above.

Note:

- In order to obtain the best control effect, please input the correct motor parameters and perform motor auto-tuning. Group F02.0x is the basic parameter group of the motor.
- In open-loop and closed-loop vector control, the drive can only drive one motor; and there shall not be too large between the level of drive capacity and that of motor capacity. The power of drive can be two levels higher or one level lower than that of the motor, otherwise it may cause degraded control performance or failure of drive system.

3 Installation and Wiring

3.1 Safety Cautions

This section explains the various precautions that must be followed to ensure safe use of this product, maximized drive performance, and reliable operation of the drive.

Caution on use of drive

 Warning	<ul style="list-style-type: none"> When installing the drive in a closed cabinet, please configure a cooling fan or cooling air conditioner to fully cool the drive. Make sure that the air inlet temperature of the drive is below 40°C to ensure that the drive can operate safely and reliably.
Important	<ul style="list-style-type: none"> During installation, please cover the upper part of the drive with cloth or paper to prevent metal chips, oil, water and other debris from falling into the drive during installation and drilling operations. Please remove such cover carefully after installation. Please follow the measures and methods specified in ESD prevention measures during operation on the drive, otherwise the drive may be damaged. If multiple drives are installed in a cabinet, sufficient space must be reserved on the upper part of the drives to facilitate the replacement of the cooling fan. Do not use the drive beyond the rated range of the drive, otherwise the drive may be damaged. When moving the drive, please hold the stable case. If only the front cover is held, the main body of the drive may fall, which may cause personal injury or damage to the drive.

Caution on use of motor

Important	<ul style="list-style-type: none"> The maximum allowable speed varies with motor models is different. Please do not exceed the maximum allowable speed of the motor. When the drive is running at low speed, the self-cooling effect of the motor will be severely reduced. Long-term running of motor at a low speed will cause damage to the motor due to overheating; if you need to run motor at a low speed for a long time, please use a motor special for frequency conversion. When a machine running at a constant speed is operated at a variable speed, resonance may occur. Please install anti-vibration rubber under the motor bracket or use the hopping frequency control function to avoid it. The torque characteristics of the motor driven by an drive and the industrial frequency power supply are different. Please confirm the torque characteristics of the mechanical equipment to be connected. The rated current of the submersible motor is greater than that of the standard motor. Please confirm the rated current of the motor and select an appropriate drive. When the distance between the motor and the drive is large, the maximum torque of the motor will be reduced due to the voltage drop. Therefore, please use a cable thick enough for connecting over a long distance.
-----------	---

3.2 Installation Environment

The installation environment is very important to give full play to the performance of this product and maintain its function for a long time. Please install this product in an environment that meets the requirements shown in the table below.

Table 3-1: Environmental conditions required for reliable operation of AC310 series drives

Environment	Requirements
Installation site	Indoor installation, free of direct sunlight.
Use temperature	-10°C~+50°C
Storage temperature	-30°C~+60°C
Ambient humidity	No condensation below 95% RH.
Surroundings	Please install the drive in the following places: <ul style="list-style-type: none"> Places free of oil mist, corrosive gas, flammable gas, and dust; Places where metal powder, oil, water and other foreign objects will not enter into the drive (do not install the drive on flammable materials such as wood); Places free of radioactive materials and flammable materials; Places free of harmful gases and liquids; Places with less salt erosion;

	<ul style="list-style-type: none"> Places without direct sunlight;
Altitude	Below 1,000 m; it shall be derated for use above 1,000 m.
Vibration	5.9 m/s ² (0.6 G) at 9 Hz - 200 Hz.
Installation and cooling	<ul style="list-style-type: none"> The drive must not be installed horizontally, but vertically; Please install braking resistors and other high-heating devices independently, rather than installing them in the same cabinet as the drive. It is strictly forbidden to install high-heating devices such as braking resistors at the air inlet of the drive.

- In order to improve the reliability of this product, please use the drive in a place where the temperature will not change sharply; when using it in a closed space such as a control cabinet, please use a cooling fan or cooling air conditioner for cooling to prevent the internal temperature from exceeding the allowable temperature; please avoid freezing the drive, since too low temperature may cause failure to some devices due to freeze.
- After exceeding the allowable ambient temperature, the drive shall be derated as shown in the following figure.

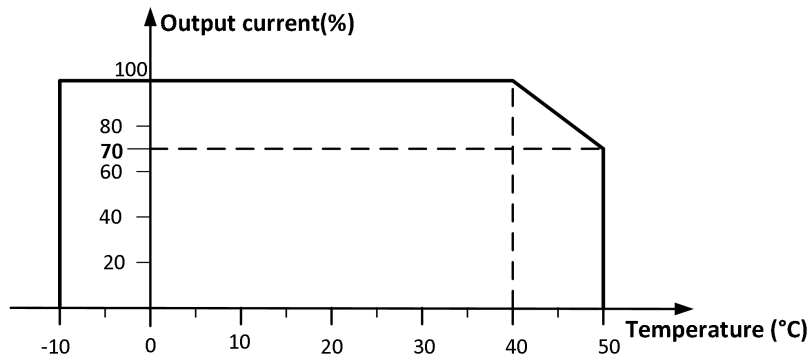

Figure 3-1: Derating curve of AC310 series drive after exceeding the allowable operating temperature

- After exceeding the allowable altitude, the drive shall be derated as shown in the following figure

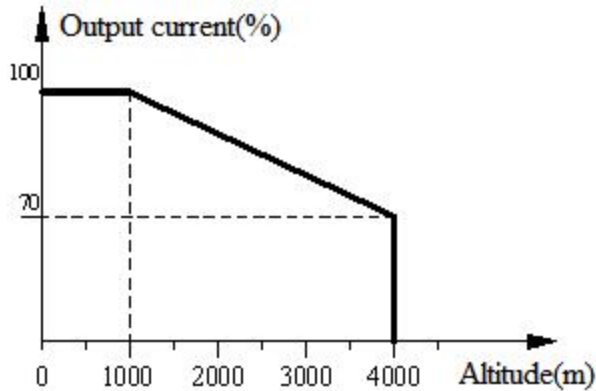

Figure 3-2 Derating curve of AC310 series drive after exceeding the allowable altitude

3.3 Installation Direction and Space

- **Direction**
Be sure to install the drive vertically to avoid reducing the cooling effect.
- **Space**
Stand-alone installation: In order to ensure the ventilation space and wiring space required for drive cooling, please be sure to comply with the installation conditions shown in the figure below. Please install the drive with its back closely attached to the wall to make the cooling air around the cooling fin flow smoothly to ensure the cooling effect.

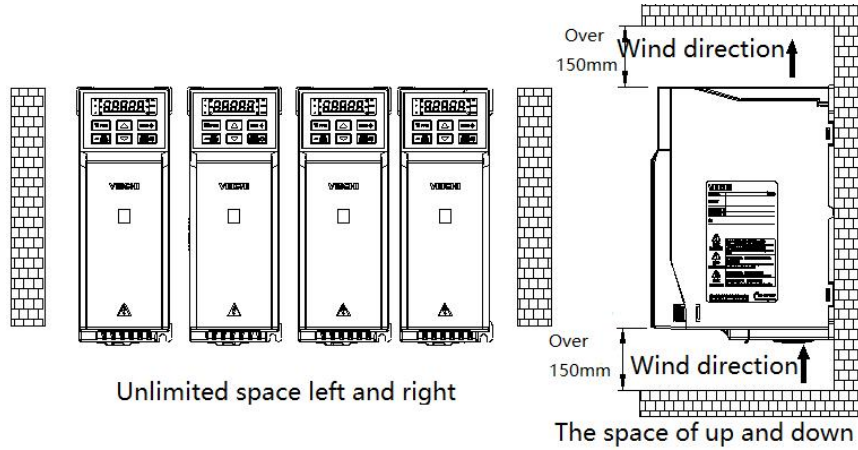
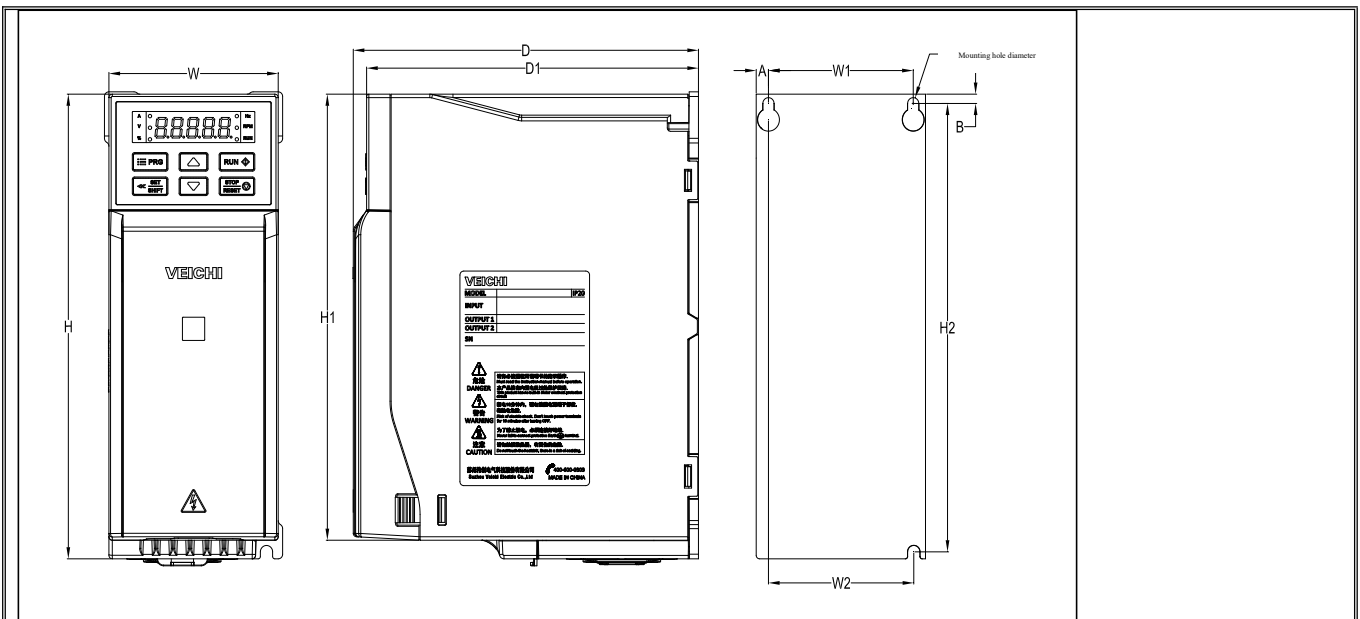

Figure 3-3: drive installation space requirements

3.4 Dimensions

3.4.1 Dimensions of drive (Plastic)



Drive Model	Boundary Dimension (mm)					Installation Dimension (mm)					Installation Bore Diameter
	W	H	H1	D	D1	W1	W2	H2	A	B	
AC310-T/S2-R75G-B	76	200	192	155	149	65	65	193	5.5	4	3-M4
AC310-T/S2-1R5G-B											
AC310-T/S2-2R2G-B	100	242	231	155	149	84	86.5	231.5	8	5.5	3-M4
AC310-T/S2-004G-B											
AC310-T/S2-5R5G-B	116	320	307.5	175	169	98	100	307.5	9	6	3-M5
AC310-T3-R75G/1R5P-B	76	200	192	155	149	65	65	193	5.5	4	3-M4
AC310-T3-1R5G/2R2P-B											

AC310-T3-2R2G-B											
AC310-T3-004G/5R5P-B	100	242	231	155	149	84	86.5	231.5	8	5.5	3-M4
AC310-T3-5R5G/7R5P-B											
AC310-T3-7R5G/011P-B	116	320	307.5	175	169	98	100	307.5	9	6	3-M5
AC310-T3-011G/015P-B											

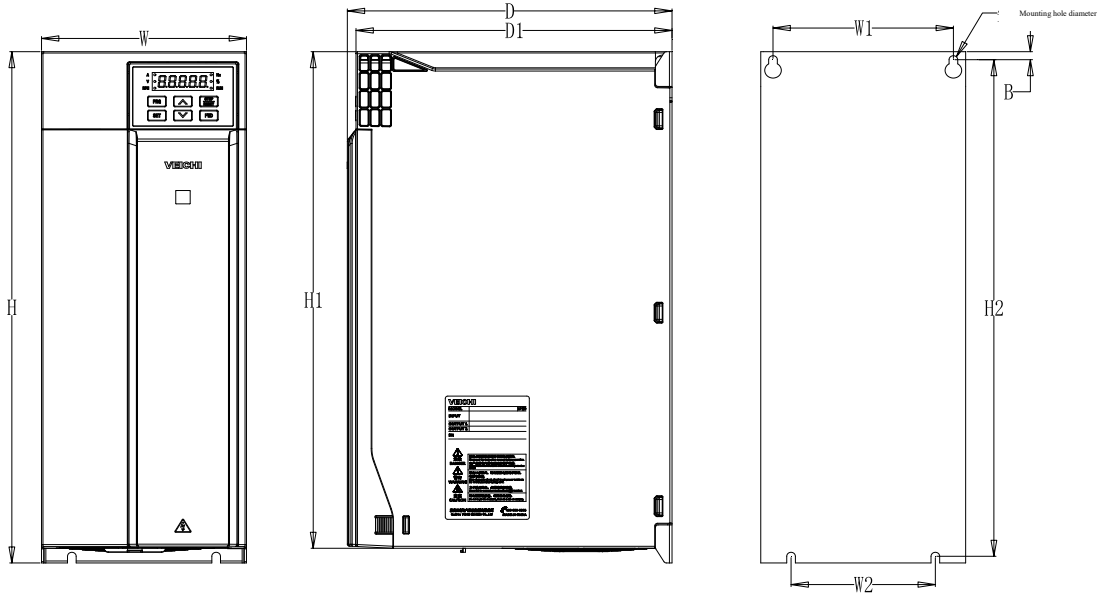

Drive Model	Boundary Dimension (mm)					Installation Dimension (mm)				Installation Bore Diameter
	W	H	H1	D	D1	W1	W2	H2	B	
AC310-T/S2-7R5G-B	142	383	372	225	219	125	100	372	6	4-M5
AC310-T/S2-011G-B										
AC310-T/S2-015G	172	430	/	225	219	150	150	416.5	7.5	4-M5
AC310-T2-018G										
AC310-T2-022G										
AC310-T3-015G/018P-B	142	383	372	225	219	125	100	372	6	4-M5
AC310-T3-018G/022P-B										
AC310-T3-022G/030P-B										
AC310-T3-030G/037P	172	430	/	225	219	150	150	416.5	7.5	4-M5
AC310-T3-037G/045P										

3.4.2 Dimensions of Drive (Steel shell)

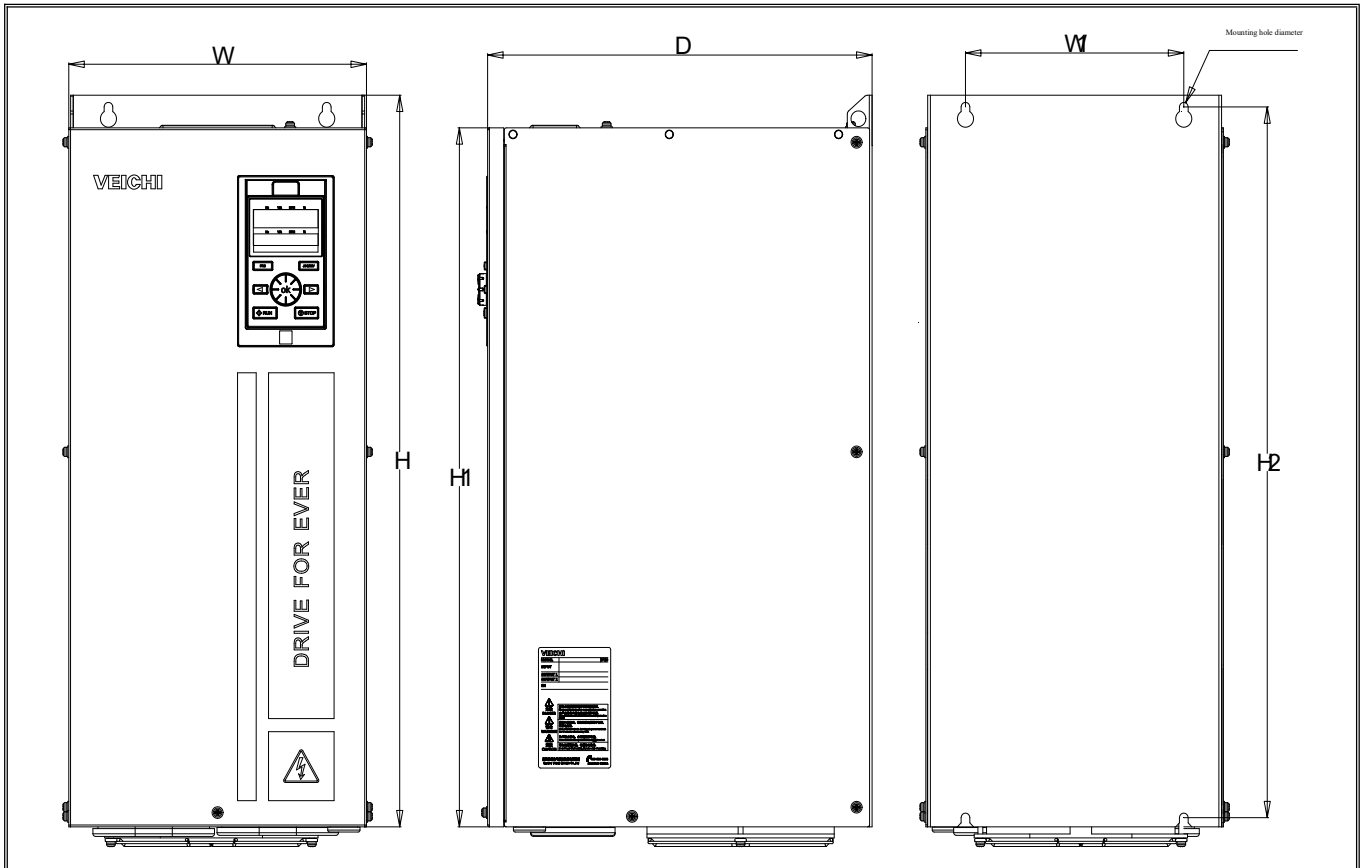

Drive Model	Boundary Dimension (mm)				Installation Bore Position (mm)		Installation Bore Diameter
	W	H	H1	D	W1	H2	
AC310-T2-030G	240	560	535	310	176	544	4-M6
AC310-T2-037G							
AC310-T2-045G							
AC310-T2-055G	270	638	580	350	195	615	4-M8
AC310-T3-045G/055P	240	560	535	310	176	544	4-M6
AC310-T3-055G/075P							
AC310-T3-075G/090P							
AC310-T3-090G/110P	270	638	580	350	195	615	4-M8
AC310-T3-110G/132P							
AC310-T3-132G/160P-L	350	738	680	405	220	715	4-M8
AC310-T3-160G/185P-L							
AC310-T3-185G/200P-L	360	940	850	480	200	910	4-M16
AC310-T3-200G/220P-L							
AC310-T3-220G/250P-L							
AC310-T3-250G/280P-L	370	1140	1050	545	200	1110	4-M16
AC310-T3-280G/315P-L							
AC310-T6-022G/030P	240	560	535	310	176	544	4-M6
AC310-T6-030G/037P							
AC310-T6-037G/045P							
AC310-T6-045G/055P							
AC310-T6-055G/075P							
AC310-T6-075G/090P							

AC310-T6-090G/110P	270	638	580	350	195	615	4-M8
AC310-T6-110G/132P							
AC310-T6-132G/160P-L	350	738	680	405	220	715	4-M8
AC310-T6-160G/185P-L							
AC310-T6-185G/200P-L	360	940	850	480	200	910	4-M16
AC310-T6-200G/220P-L							
AC310-T6-220G/250P-L							
AC310-T6-250G/280P-L	370	1140	1050	545	200	1110	4-M16
AC310-T6-280G/315P-L							
AC310-T3-315G/355P-L	400	1250	1140	545	240	1213	4-M16
AC310-T3-355G/400P-L							
AC310-T3-400G/450P-L							
AC310-T3-450G/500P-L	460	1400	1293	545	300	1363	4-M16
AC310-T3-500G/560P-L							
AC310-T3-560G/630P-L							
AC310-T6-315G/355P-L	400	1250	1140	545	240	1213	4-M16
AC310-T6-355G/400P-L							
AC310-T6-400G/450P-L							
AC310-T6-450G/500P-L	460	1400	1293	545	300	1363	4-M16
AC310-T6-500G/560P-L							
AC310-T6-560G/630P-L							

3.4.3 Dimensions of Drive (Cabinet)

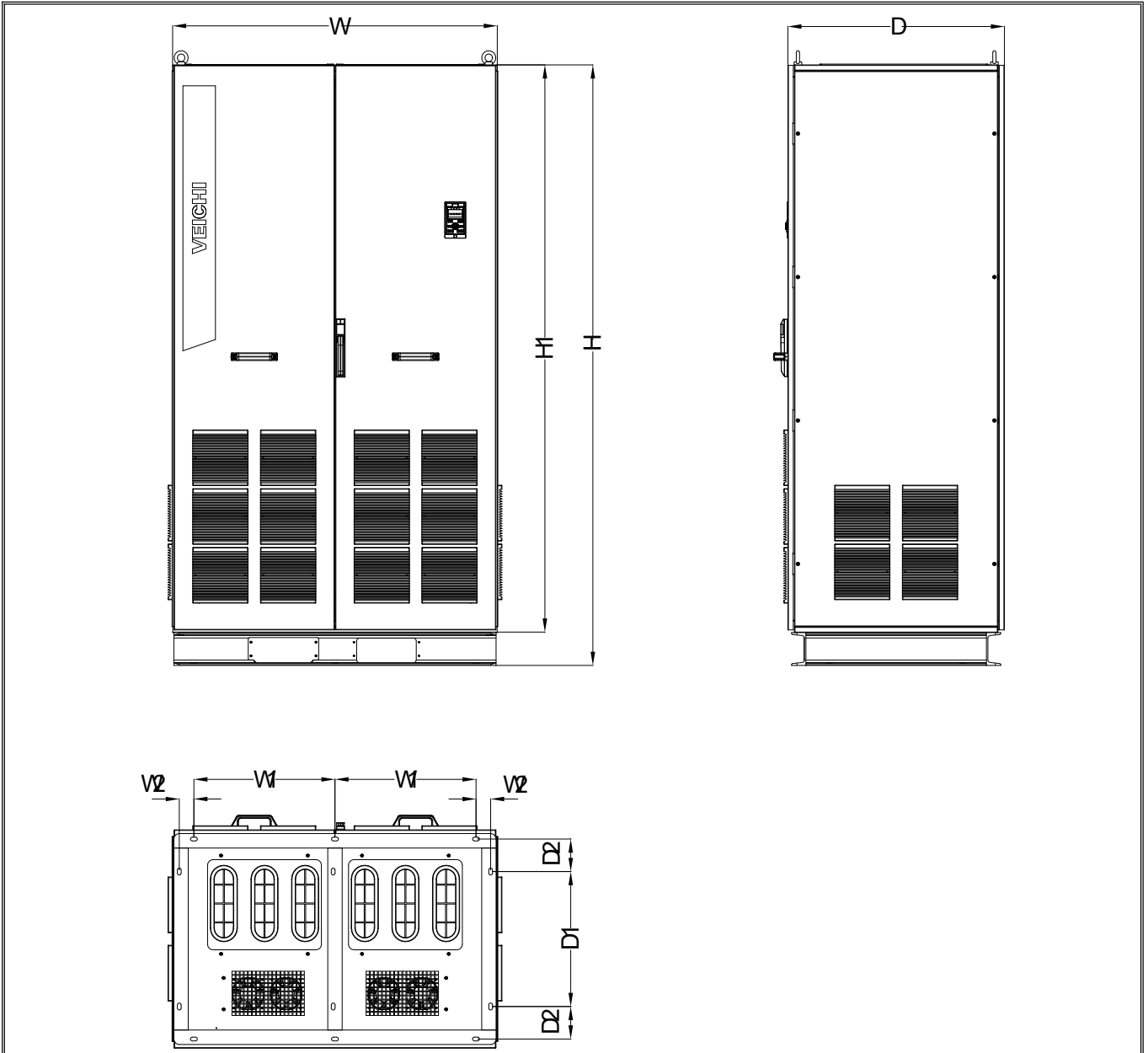

Drive Model	Boundary Dimension (mm)				Installation Bore Position (mm)		Installation Bore Diameter
	W	H	H1	D	W1	D1	
AC310-T3-630G/710P-LD	1201	2198	2078	798	520	711	φ14
AC310-T3-710G/800P-LD							
AC310-T3-800G/900P-LD							
AC310-T3-900G/1000P-LD							
AC310-T3-1000G/1120P-LD							
AC310-T3-1120G-LD							
AC310-T6-630G/710P-LD							
AC310-T6-710G/800P-LD							
AC310-T6-800G/900P-LD							
AC310-T6-900G/1000P-LD							
AC310-T6-1000G/1120P-LD							
AC310-T6-1120G-LD							

3.4.4 Keypad dimensions

- **Boundary dimension and bore dimension of external dual-line keypad (unit: mm)**

Model: KBD300-25

Note: The boundary dimensions and bore dimensions of the LCD and LED keypads are fully compatible.

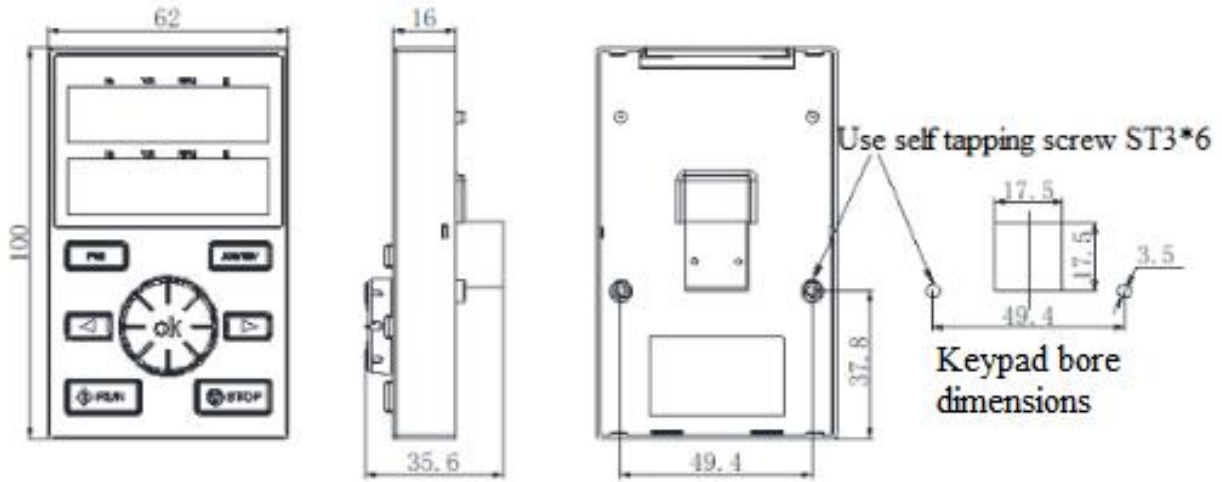

Boundary Dimensions and Bore Dimensions of External Dual-line Keypad

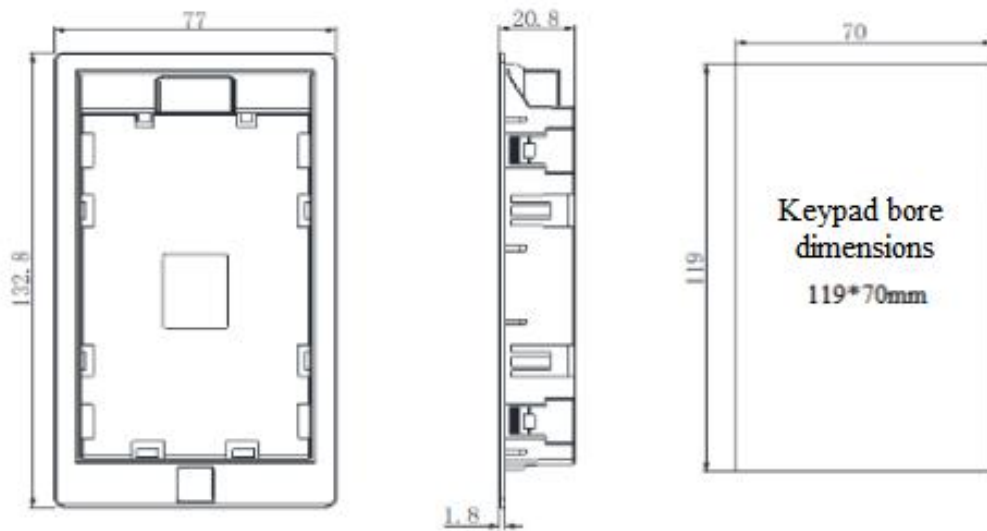

Boundary Dimensions and Bore Dimensions of External Dual-line Keypad Pocket

- **Boundary Dimensions and Bore Dimensions of Outer Single-Line Keypad**

Model: KBD10-15

Note: Bore dimensions of mounting plate: 61 mm x 36 mm. (Unit: mm)

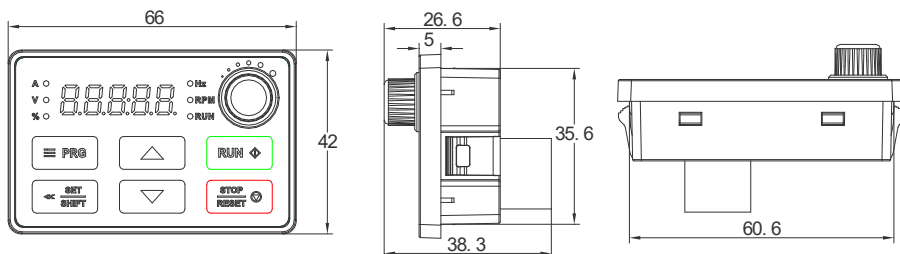

Boundary Dimension of Externally Single-line Keypad

3.5 Standard Wiring

This section describes various precautions and requirements that must be followed to ensure safe use of this product, maximized drive performance, and reliable operation of the drive.

Safety Considerations

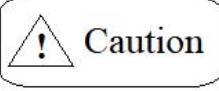
 Warning	<ul style="list-style-type: none">• The drive must be grounded reliably when it is put into operation, otherwise it may cause personal injury or death and failure of the device.• In order to ensure the safe operation of the drive, the installation and wiring must be carried out by trained professionals.• Do not perform wiring-related operations while the power is on, otherwise there is a risk of death due to electric shock.• Please cut off the power supply of all related equipment before performing wiring operations. Confirm that the main circuit DC voltage has dropped to a safe level and then wait 5 minutes before performing related operations.
 Caution	<ul style="list-style-type: none">• The wiring of the control cable and the power cable of the drive, and the connecting cable to the motor must be isolated from each other, rather than arranging them in the same cable trough or on the same cable rack.• This device can only be used for the purpose specified by the manufacturer. If you need to use it in other special occasions, please consult our sales department.
Important	<ul style="list-style-type: none">• It is forbidden to use high-voltage insulation testing device to test the insulation of the drive and the insulation of the cables connected to the drive.• When the drive and external devices (filters, reactors, etc.) need insulation test, their insulation resistance to ground shall be first measured with a 500 V megameter, and the insulation resistance shall not be less than 4 MΩ.

3.5.1 Standard connection diagram

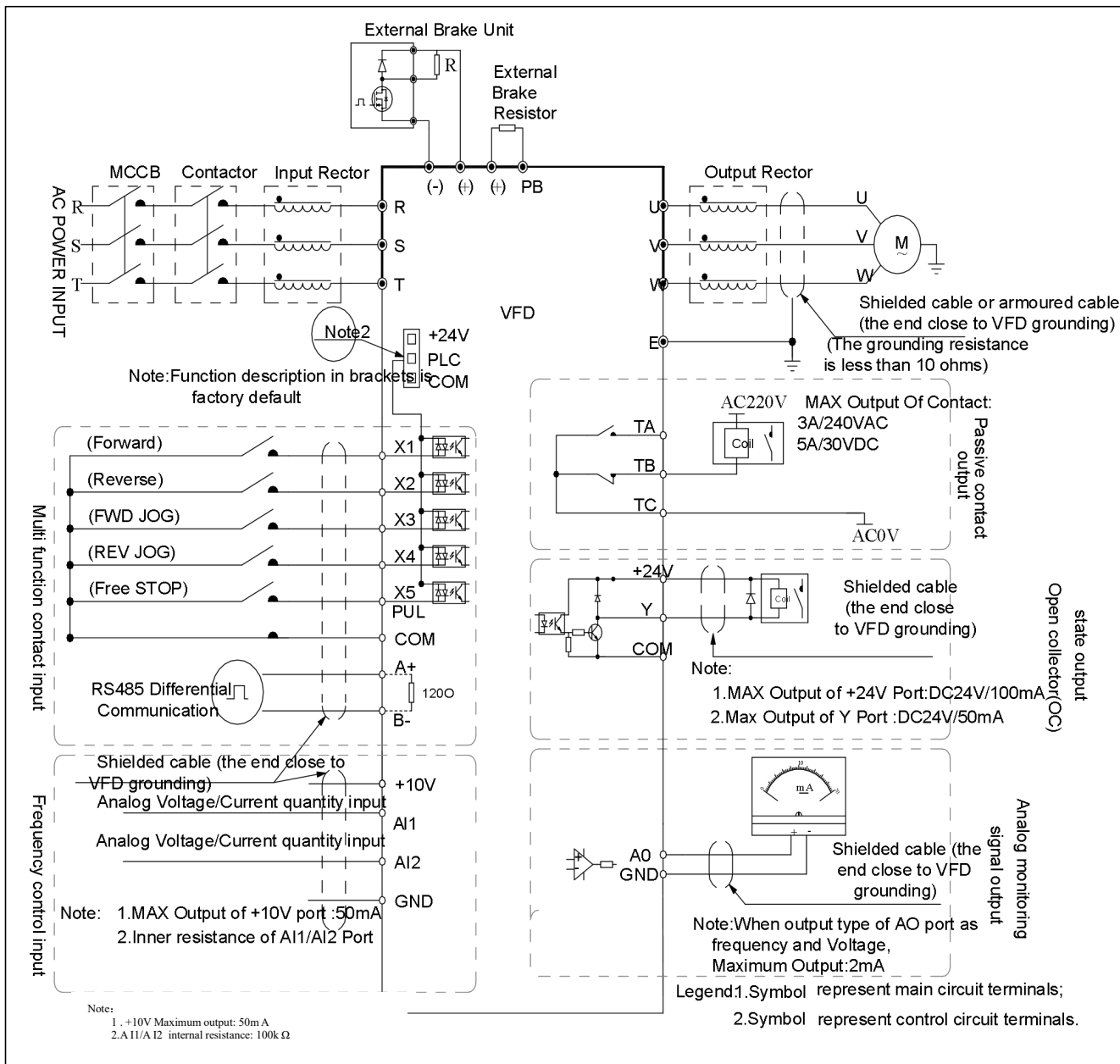

Figure 3-4: Standard connection diagram

Note:

- For T3 models with power of 22 kW and below, and models with built-in braking unit, braking resistors can be connected as required; for models without built-in braking unit, external braking units can be installed as needed.
- The terminals (X1 - X5/PUL) can support NPN or PNP transistor input signals, and the voltage supply can be selected from the drive's internal power supply (+24 V terminal) or external power supply (PLC terminal).
- For drives above 560kw, only 485 communication is supported, no other communication is supported

3.5.2 Auxiliary terminal output capacity

Terminal	Definition of Function	Maximum Output
+10V	10 V auxiliary power output, forming a loop with GND.	50mA
A0	Analog output, forming a loop with GND.	The maximum output is 2 mA for the signal of frequency and voltage type.
+24V	24 V auxiliary power output, forming a loop with COM.	100mA
Y	Open collector output; the action object can be set by program.	DC24V/50mA

TA/TB/TC	Passive contact output; the action object can be set by program.	3A/240VAC 5A/30VDC
----------	--	--------------------

3.5.3 Illustration and description of DIP switch function

Position Number	Position	Function Description
RS485	terminal resistance	RS485 communication connected to 120 Ω terminal resistance.
AO-F	AO output-frequency	AO output; output of 0.0 kHz - 100 kHz frequency. Switch to ON of AO-F; external pull-up is required (Generally pull up to 10 V when connecting to 5.1 kΩ).
AO-U	AO output-current	AO output; current output of 0 mA - 20 mA or 4 mA - 20 mA.
AI1	AI1 input-current/voltage	AI1 input of 0 mA - 20 mA or AI1 input of 0 V - 10 V.
AI2	AI2 input-current/voltage	AI2 input of 0 mA - 20 mA or AI2 input of 0 V - 10 V.

3.5.4 Multi-function input point connection

Wiring method of PNP characteristic transistor:

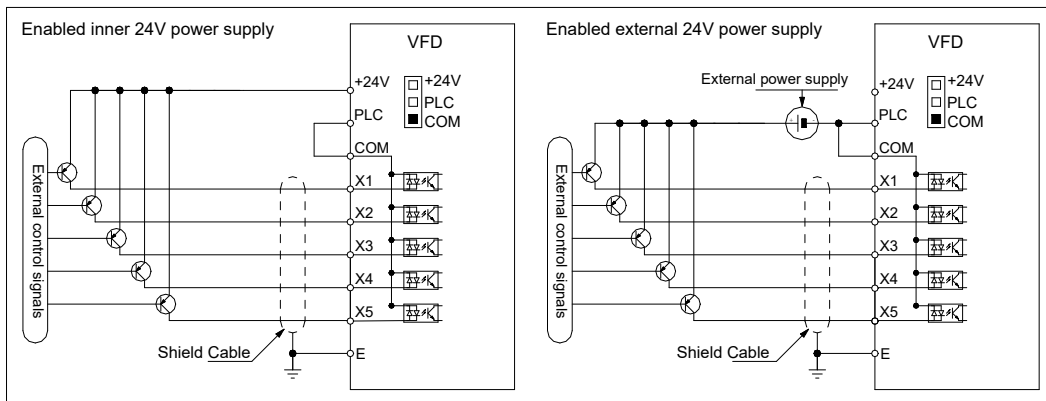

Wiring method of NPN characteristic transistor:

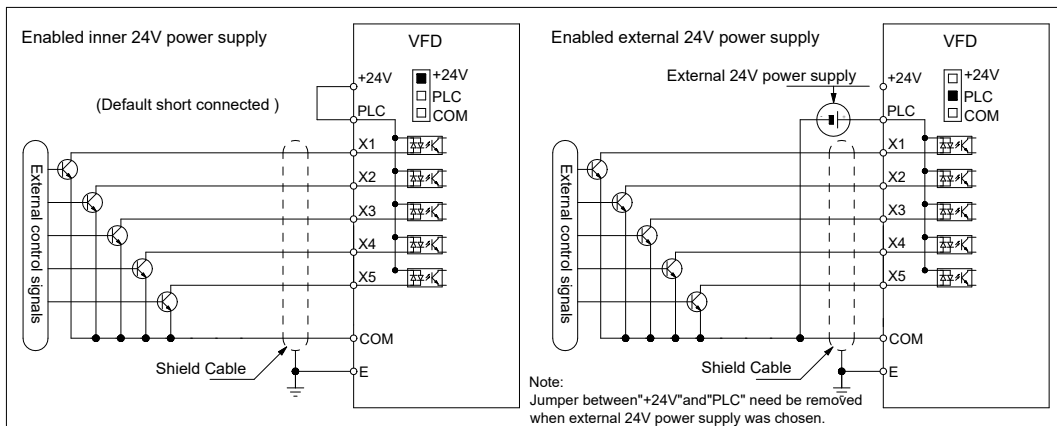

3.5.5 Connection diagram of jumper caps "+24V", "PLC", "COM"

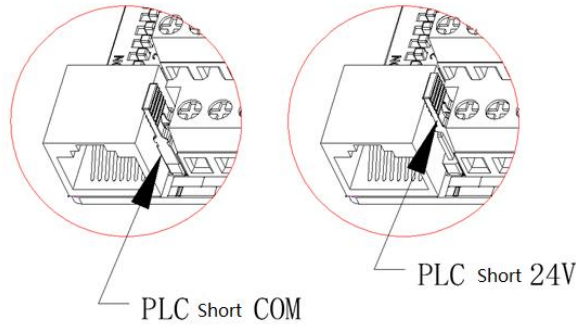

3.6 Wiring of Main Circuit

3.6.1 Arrangement and definition of terminals

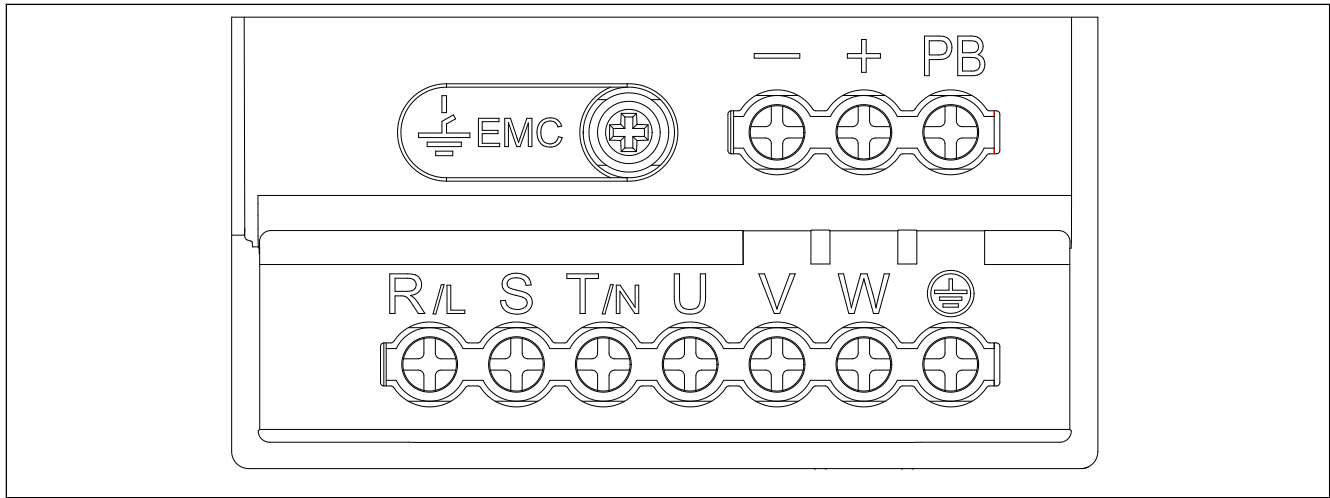
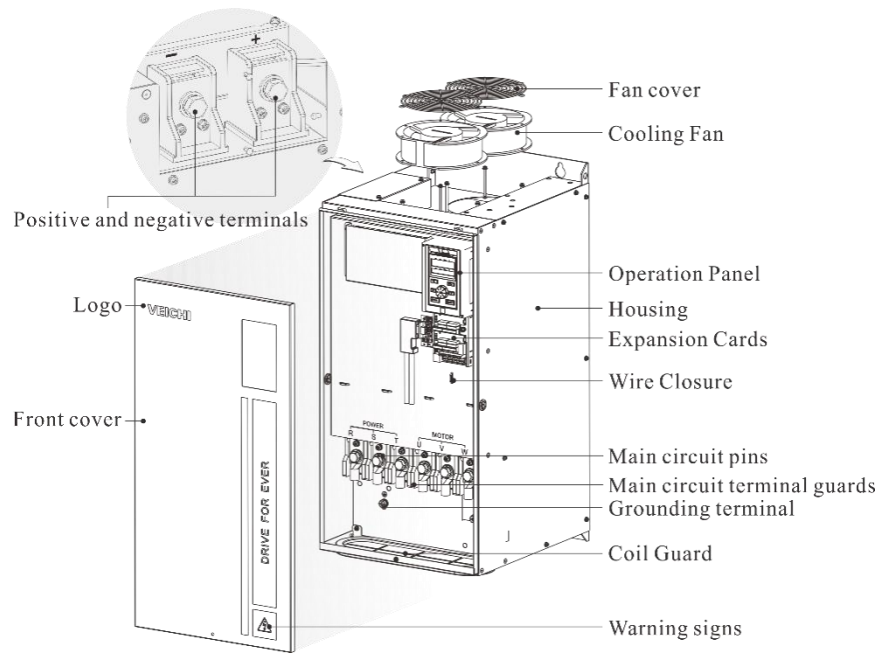

Table 3-2: Arrangement and Definition of Terminals of AC310 Series Drive Main Circuit

Terminal Symbol	Terminal Name	Functional Definition
(+)	DC power terminal	Output DC power; (-) is the cathode of the DC bus, and (+) is the anode of the DC bus; for connecting an external braking unit.
(-)		
(+)	Brake resistor terminal	For connecting external braking resistor to realize quick stop.
PB		
R	Drive input terminal	For connecting three-phase AC supply.
S		
T		
U	Drive output terminal	For connecting motor.
V		
W		
⏏	Grounding	Grounding terminal, with the grounding resistance < 10 Ω.
E		

Note:

- The structure diagram of AC310 series iron shell machine drive is shown below.



Among them, the + - terminal is located on the left side of the drive under the fixed small iron plate (as shown above, this small iron plate can be easily removed).

3.6.2 Main circuit wiring of three-phase 380 V drive

Table 3-3: Recommended wire diameter and fixed torque of the main circuit of three-phase 380 V drive

Model	Specifications of Screws for Main Circuit Terminal (mm)	Recommended Fixed Torque (N·m)	Specifications of Recommended Copper Core Cable (mm ²) (AWG)
AC310-T3-R75G	M3	0.8~1.0	1.5mm ² (14)
AC310-T3-1R5G	M3	0.8~1.0	2.5mm ² (12)
AC310-T3-2R2G	M3	0.8~1.0	2.5mm ² (12)
AC310-T3-004G	M3.5	1.2~1.5	4mm ² (10)
AC310-T3-5R5G	M3.5	1.2~1.5	6mm ² (9)
AC310-T3-7R5G	M4	1.2~1.5	6mm ² (9)
AC310-T3-011G	M4	1.2~1.5	10mm ² (7)
AC310-T3-015G	M6	4~6	10mm ² (7)
AC310-T3-018G	M6	4~6	16mm ² (5)
AC310-T3-022G	M6	4~6	16mm ² (5)
AC310-T3-030G	M6	4~6	25mm ² (3)
AC310-T3-037G	M6	4~6	25mm ² (3)
AC310-T3-045G	M8	8~10	35mm ² (2)
AC310-T3-055G	M8	8~10	35mm ² (2)
AC310-T3-075G	M8	8~10	50mm ² (1)
AC310-T3-090G	M8	8~10	50mm ² (1/0)
AC310-T3-110G	M8	8~10	70mm ² (2/0)
AC310-T3-132G	M12	14~16	95mm ² (3/0)
AC310-T3-160G	M12	14~16	95mm ² (4/0)
AC310-T3-185G	M12	14~16	120mm ²
AC310-T3-200G	M12	14~16	150mm ²
AC310-T3-220G	M12	14~16	150mm ²
AC310-T3-250G	M12	14~16	185mm ²
AC310-T3-280G	M12	14~16	185mm ²
AC310-T3-315G	M16	20~23	240mm ²
AC310-T3-355G	M16	20~23	240mm ²
AC310-T3-400G	M16	20~23	300mm ²

AC310-T3-450G	M16	20~23	400mm ²
AC310-T3-500G	M16	20~23	400mm ²
AC310-T3-560G	M16	20~23	500mm ²
AC310-T3-630G	M16	20~23	500mm ²
AC310-T3-710G	M16	20~23	500mm ²

Note: For drive above 185 kW, it is recommended to use copper bars as electrical connections for the main circuit. For the cross-sectional area of the copper bars, please refer to the "Specifications of recommended copper core cable (mm²)" in the above table.

3.6.3 Main circuit wiring of Single/Three-phase 220 V drive

Table 3-4: Recommended wire diameter and fixed torque of the main circuit of single/three-phase 220 V drive

Model	Specifications of Screws for Main Circuit Terminal (mm)	Recommended Fixed Torque (N·m)	Specifications of Recommended Copper Core Cable (mm ²) (AWG)
AC310-T/S2-R40G	M3	0.8~1.0	1.5mm ² (14)
AC310-T/S2-R75G	M3	0.8~1.0	2.5mm ² (12)
AC310-T/S2-1R5G	M3	0.8~1.0	2.5mm ² (12)
AC310-T/S2-2R2G	M3.5	1.2~1.5	4mm ² (10)
AC310-T/S2-004G	M3.5	1.2~1.5	4mm ² (10)
AC310-T/S2-5R5G	M4	1.2~1.5	10mm ² (7)
AC310-T/S2-7R5G	M6	4~6	16mm ² (5)
AC310-T/S2-011G	M6	4~6	16mm ² (5)
AC310-T/S2-015G	M6	4~6	25mm ² (3)
AC310-T2-018G	M6	4~6	25mm ² (3)
AC310-T2-022G	M6	4~6	25mm ² (3)
AC310-T2-030G	M8	8~10	35mm ² (2)
AC310-T2-037G	M8	8~10	50mm ² (1)
AC310-T2-045G	M8	8~10	50mm ² (1)
AC310-T2-055G	M8	8~10	70mm ² (2/0)

3.6.4 Recommended main circuit components specification

Table 3-5: Recommended specifications of other accessories for the main circuit of three-phase 380 V drive

Model	Contactor	Circuit Breaker	DC Reactor	Input Filter	Output Filter
AC310-T3-R75G	10A	10A	-----	NFI-005	NFO-010
AC310-T3-1R5G	10A	10A	-----	NFI-005	NFO-010
AC310-T3-2R2G	16A	15A	-----	NFI-010	NFO-010
AC310-T3-004G	16A	20A	-----	NFI-010	NFO-010
AC310-T3-5R5G	25A	20A	-----	NFI-020	NFO-020
AC310-T3-7R5G	25A	30A	-----	NFI-020	NFO-020
AC310-T3-011G	32A	40A	-----	NFI-036	NFO-036
AC310-T3-015G	40A	50A	-----	NFI-036	NFO-036
AC310-T3-018G	50A	60A	-----	NFI-050	NFO-050
AC310-T3-022G	50A	75A	-----	NFI-050	NFO-050
AC310-T3-030G	63A	100A	DCL-80	NFI-080	NFO-080
AC310-T3-037G	80A	125A	DCL-100	NFI-100	NFO-100
AC310-T3-045G	100A	150A	DCL-110	NFI-100	NFO-100
AC310-T3-055G	125A	175A	DCL-125	NFI-150	NFO-150
AC310-T3-075G	160A	200A	DCL-150	NFI-150	NFO-150
AC310-T3-090G	220A	250A	DCL-200	NFI-200	NFO-300

AC310-T3-110G	220A	300A	DCL-200	NFI-200	NFO-300
AC310-T3-132G	250A	400A	DCL-300	NFI-300	NFO-300
AC310-T3-160G	300A	500A	DCL-300	NFI-300	NFO-300
AC310-T3-185G	400A	600A	DCL-400	NFI-400	NFO-400
AC310-T3-200G	400A	700A	DCL-400	NFI-400	NFO-400
AC310-T3-220G	630A	800A	DCL-500	NFI-600	NFO-600
AC310-T3-250G	630A	1000A	DCL-600	NFI-600	NFO-600
AC310-T3-280G	630A	1200A	DCL-600	NFI-600	NFO-600
AC310-T3-315G	630A	1200A	DCL-800	-----	-----
AC310-T3-355G	800A	1400A	DCL-800	-----	-----
AC310-T3-400G	1000A	1600A	DCL-1000	-----	-----
AC310-T3-450G	1000A	2000A	DCL-1000	-----	-----
AC310-T3-500G	1000A	2000A	DCL-1200	-----	-----
AC310-T3-560G	1200A	2000A	DCL-1200	-----	-----
AC310-T3-630G	1200A	2000A	DCL-1200	-----	-----
AC310-T3-710G	1400A	2000A	DCL-1200	-----	-----

Note: For detailed specifications and circuit connection forms of DC reactors, input filters, output filters, etc., please refer to the "External Units and Optional Parts" section.

3.7 Wiring of Control Circuit

3.7.1 Arrangement of control circuit terminals

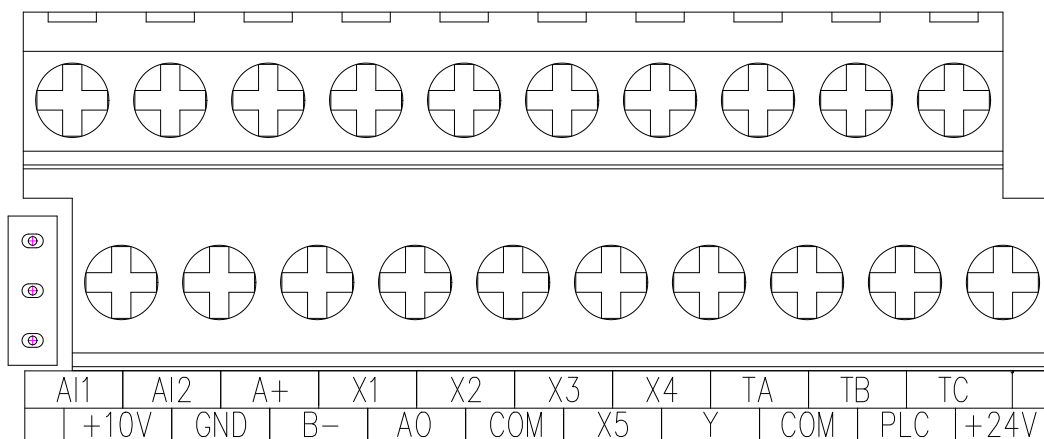

Table 3-6: Arrangement and definition of terminals of AC310 series drive control circuit

Types	Terminal Symbol	Terminal Name	Functional Definition
Power supply	+10V-GND	External +10 V power supply	Provide +10 V power supply, with maximum output current of 50 mA; generally used as the power supply for external potentiometer with the resistance range of 1 k Ω - 5 k Ω .
	+24V-COM	External +24 V power supply	Provide +24 V power supply, generally used as the power supply for digital input and output terminals and for external sensors. Maximum output current: 100 mA
	PLC	External common terminal	Connected to +24 V by default When X1-X5/PUL is driven with external signals, PLC needs to be connected to external power supply and disconnected from the +24 V power supply (see "+24V", "PLC", "COM" connection diagram for details).
Analog Input	AI1-GND	Voltage or Current Analog Input	1. Input current range: DC 0 V - 10 V/0 mA - 20 mA. 2. Voltage model input impedance: 100 k Ω .

			3. Current input impedance: 500 Ω.
	AI2-GND	Voltage or Current Analog Input	1. Input range: DC 0 V - 10 V/0 mA - 20 mA. 2. Voltage input impedance: 100 kΩ. 3. Current input impedance: 500 Ω.
Digital Input	X1-PLC	Multi-function contact input 1	Opto-coupler isolation, compatible with bipolar input. 1. Input impedance: 4.4 kΩ. 2. High-level input voltage range: 10 V - 30 V. 3. Low-level input voltage range: 0 V - 5 V.
	X2-PLC	Multi-function contact input 2	
	X3-PLC	Multi-function contact input 3	
	X4-PLC	Multi-function contact input 4	
	X5-PLC	Multi-function contact input 5	
	X5/PUL-PLC	Multi-function contact input 5/high-speed pulse input	In addition to the characteristics of X1 - X4, X5 can also be used as a high-speed pulse input channel (single model). 1. Opto-coupler isolation, compatible with bipolar input, with the maximum input frequency of 100 kHz. 2. Input impedance: 1.5 kΩ. 3. Pulse input level range: 10 V - 30 V.
Analog Output	AO-GND	Analog output	1. Output voltage range: DC 0 V - 10 V. 2. Output current range: DC 0 mA - 20 mA. 3. Pulse output range: 0 kHz - 50 kHz.
Digital Output	Y-COM	Digital output 1	Optocoupler isolation, open collector output 1. Output voltage range: DC 0 V - 30 V. 2. Output current range: DC 0 mA - 50 mA.
Relay output	TA-TC	Normally open terminal	Contactor drive capability: 240 VAC, 3 A. 30 VDC, 5 A.
	TB-TC	Normally closed terminal	
Communication terminal	A+	Communication terminal A+	RS485 communication interface. According to the illustration and description of DIP switch function, the position of the RS485 DIP switch determines whether the RS485 communication is connected to 120 Ω terminal resistor.
	B-	Communication terminal B-	

3.7.2 Wiring specifications of control circuit terminals

Table 3-7: Wiring specifications of control circuit terminals

Terminal Name	Screw Model (mm)	Fixed Torque (N·m)	Cable Model (mm ²)	Cable Type
A+ B-	M2.5	0.4~0.6	0.75	Shielded twisted pair cable
+10V GND A0 A1 A2	M2.5	0.4~0.6	0.75	Shielded twisted pair cable
+24V COM Y TA TB TC PLC X1 X2 X3 X4 X5/PUL	M2.5	0.4~0.6	0.75	Shielded cable

3.8 Braking Resistor Settings

- Connection of brake resistor for machines below 22 kW (inclusive)

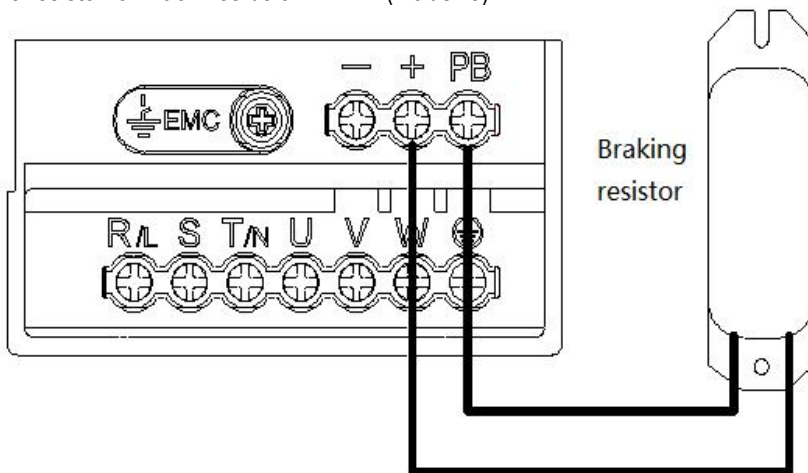

Figure 3-5: Connection diagram of braking resistor for AC310 series drive below 22 kW (inclusive)

- Connection of braking unit for the drive above 30 kW (inclusive).

Note: Braking unit is optional for machine of 30 kW - 110 kW

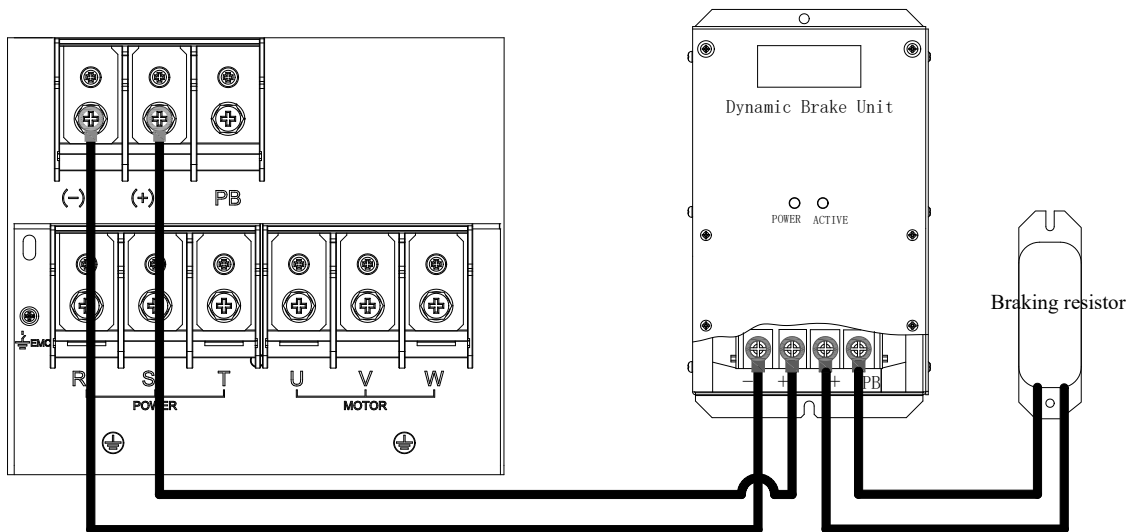

Figure 3-6: Connection diagram of braking resistor for AC310 series drive above 30 kW (inclusive)

- Recommended specifications of brake resistor

The resistance value and power of the braking resistor described in the following table are determined for the normal inertia load and the intermittent braking mode. If it needs to be used in the applications with large inertia load and long-time frequent braking, please adjust the resistance value and power of the brake resistor appropriately according to the specifications of drive and the rated parameters of braking unit. If you have any questions, please consult the customer service department of Suzhou VEICHI Electric Co., Ltd.

Three-Phase 380 V			
Motor Power (kW)	Resistance Value	Resistance Power (W or kW)	Braking Torque (%)
0.75 kW	750Ω	150W	100%
1.5 kW	400Ω	300W	100%
2.2 kW	250Ω	400W	100%
4.0 kW	150Ω	500W	100%
5.5 kW	100Ω	600W	100%
7.5 kW	75Ω	780W	100%
11 kW	50Ω	1.2kW	100%
15 kW	40Ω	1.5kW	100%
18.5 kW	35Ω	2.0kW	100%
22 kW	32Ω	2.5kW	100%
30 kW	24Ω	3.0kW	100%
37 kW	20Ω	3.7kW	100%
45 kW	16Ω	4.5kW	100%

55 kW	13Ω	5.5kW	100%
75 kW	9.0Ω	7.5kW	100%
90 kW	6.8Ω	9.3kW	100%
110 kW	6.2Ω	11.0kW	100%
132 kW	4.7Ω	13.0kW	100%
160 kW	3.9Ω	15.0kW	100%
185 kW	3.3Ω	17.0kW	100%
200 kW	3.0Ω	18.5kW	100%
220 kW	2.7Ω	20.0kW	100%
250 kW	2.4Ω	22.5kW	100%
280 kW	2.0Ω	25.5kW	100%
315 kW	1.8Ω	30.0kW	100%
355 kW	1.5Ω	33.0kW	100%
400 kW	1.2Ω	42.0kW	100%
450 kW	1.2Ω	42.0kW	100%
500 kW	1.0Ω	42.0kW	100%
560 kW	1.0Ω	50.0kW	100%
630 kW	0.8Ω	60.0kW	100%
710 kW	0.8Ω	70.0kW	100%
Single/Three-Phase 220 V			
Motor Power (kW)	Resistance Value	Resistance Power (W or kW)	Braking Torque (%)
0.4 kW	400Ω	100W	100%
0.75 kW	200Ω	120W	100%
1.5 kW	100Ω	300W	100%
2.2 kW	75.0Ω	300W	100%
4.0 kW	50.0Ω	500W	100%
5.5kW	32.0Ω	600W	100%
7.5kW	25.0Ω	780W	100%
11kW	16.0Ω	1.2kW	100%
15kW	13Ω	1.5kW	100%

18.5kW	8.2Ω	2.0kW	100%
22kW	7.5Ω	2.5kW	100%
30kW	6.2Ω	3.0kW	100%
37kW	4.7Ω	3.7kW	100%
45kW	3.9Ω	4.5kW	100%
55kW	3.0Ω	5.5kW	100%

Table 3-8: Recommended specifications of brake resistors for AC310 series drives

The brake resistor shall be selected according to the power generated by the motor in the actual application. It is related to system inertia, deceleration time, potential energy load, etc. Customers shall make selection according to the actual situation. For the system with greater inertia, shorter deceleration time, and more frequent braking, the power of the brake resistor required shall be greater and the resistance value smaller.

➤ **Resistance selection**

Formula: $P_B = U^2/R$

Wherein, U is the selected brake voltage; P_B is braking power.

➤ **Power selection**

The brake resistor needs to be derated by 70%.

Formula: $P_R = P_B * Kc/0.7$

Wherein, P_R is brake resistor power; P_B is braking power; Kc is braking frequency.

The value of braking frequency Kc for common load types is generally as follows:

Elevator: Kc = 10-15%

Oil field kowtow machine: Kc = 10-20%

Unwinding and winding: Kc = 50-60%

Centrifuge: Kc = 5-20%

Cranes with a lowering height of more than 100 m: Kc = 20-40%

Accidental braking load: Kc = 5%

Others: Kc = 10%

- The maximum braking output of the built-in braking unit

In actual use, you can select a built-in braking unit for AC310 series products with low power rating according to recommended specifications of the brake resistor in Table 3-8. In the applications with large inertia load and long-time frequent braking, it may be necessary to increase the braking torque. The table below shows the maximum braking output. In actual use, the range given in the table below shall not be exceeded, otherwise the device may be damaged. If you have any questions, please consult the customer service department of Suzhou VEICHI Electric Co., Ltd.

Table 3-9: Maximum braking output of the built-in braking unit for AC310 series drive

Three-Phase 380 V			
Drive Model	Motor Power	Max. Braking Current	Min. Resistance
AC310-T3-R75G-B	0.75 kW	8A	100Ω
AC310-T3-1R5G-B	1.50 kW	8A	100Ω
AC310-T3-2R2G-B	2.2 kW	8A	100Ω
AC310-T3-004G-B	4.0 kW	20A	40Ω
AC310-T3-5R5G-B	5.5 kW	20A	40Ω
AC310-T3-7R5G-B	7.5 kW	20A	40Ω

AC310-T3-011G-B	11.0 kW	28A	28Ω
AC310-T3-015G-B	15.0 kW	40A	20Ω
AC310-T3-018G-B	18.5 kW	40A	20Ω
AC310-T3-022G-B	22.0 kW	60A	15Ω
Single/Three-Phase 220 V			
Drive Model	Motor Power	Max. Braking Current	Min. Resistance
AC310-T/S2-R40G-B	0.40 kW	8A	50Ω
AC310-T/S2-R75G-B	0.75 kW	8A	50Ω
AC310-T/S2-1R5G-B	1.50 kW	8A	50Ω
AC310-T/S2-2R2G-B	2.2 kW	20A	20Ω
AC310-T/S2-004G-B	4.0 kW	20A	20Ω
AC310-T/S2-5R5G-B	5.5kW	28A	15Ω
AC310-T/S2-7R5-B	7.5kW	40A	10Ω
AC310-T/S2-011G-B	11kW	60A	6.5Ω

3.9 Backup Control System

Drives are composed of semiconductor devices, passive electronic devices, and motion devices. These devices have a service life. Even under normal working conditions, some characteristics changes or failures may occur to these devices, leading to product failures. In order to prevent product failures from causing loss of production stop, it is recommended to set up a backup control system while using the drive.

The following figure shows the backup control system that manually switches to the grid power to directly drive the motor after the drive fails. In actual use, you can select, according to actual needs and use environment, the grid power Y/Δ step-down start mode, the grid power auto-coupling step-down start mode and grid power soft start mode to drive motor, and other standby control systems such as standby frequency conversion system.

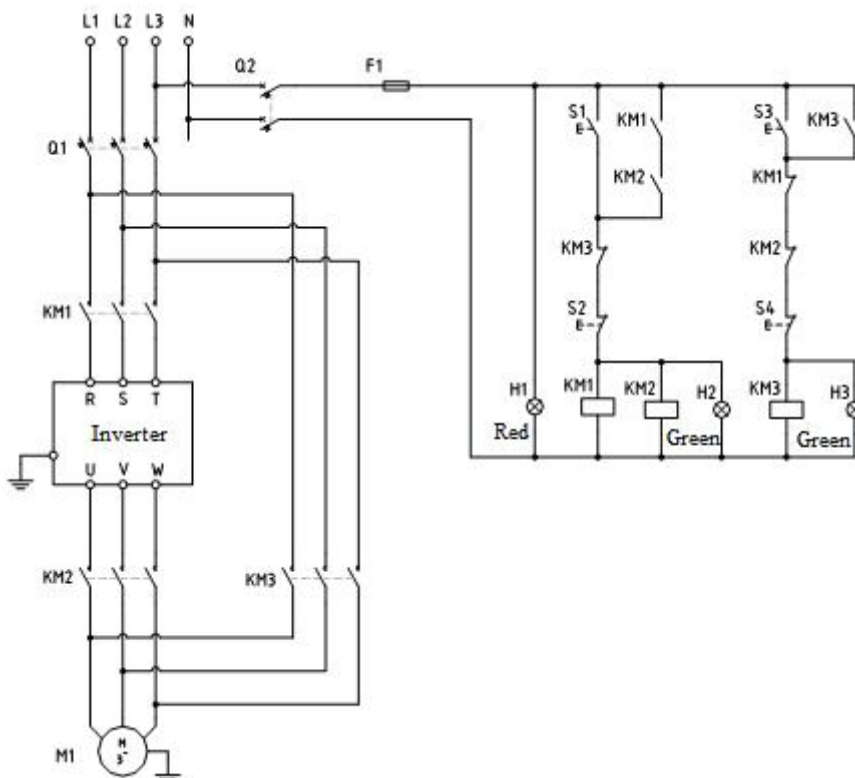

Figure 3-7: Standby Control System with Power Grid Directly Driving the Motor

4 Initial Start and Test-run

4.1 Safety Cautions

Danger

Please follow all the safety instructions in this manual.

Failure to follow the precautions may result in death or serious injury. Please be cautious. We will not take any responsibility for personal injuries and equipment damages caused by your company or your customers due to not complying with the contents of this Manual.





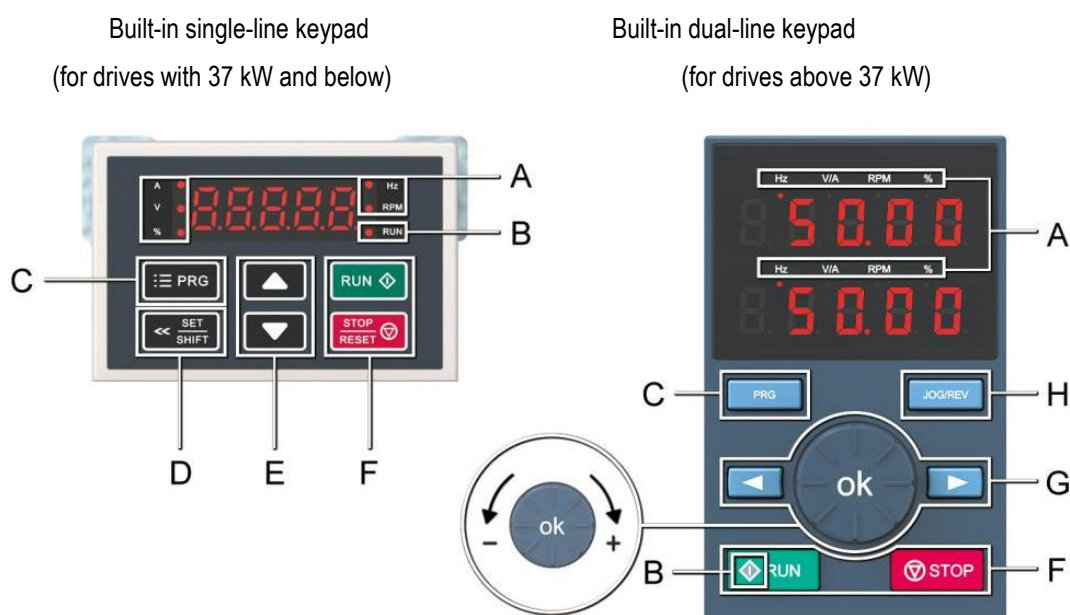

4.2 Name and Function of Each Part of the Keypad

- Keypad name



































- Keypad functions

Symbol	Built-in single-line keypad	Built-in dual-line keypad	Function
A	Unit indicator		Hz: Frequency A: Current V: Voltage A/V: Current or Voltage RPM: Revolutions Per Minute %: Percentage
B	Status indicator		On: Forward running status Blinking: Reverse running status Off: Stop status
C	Menu button 	Menu button 	Press to enter the function menu interface in standby or running status; press this button to exit the modification in parameter modification state; press and hold (for 1 second) this button to directly enter the status interface in standby or running status.
D	Set/Shift button 		Set function: After changing the value, press this button to confirm the change. Shift function: Press and hold (for 1 second) this button to move the operating position; press and hold to perform cyclic shift.
E	Up and down buttons 		Press Up button to increase the operation value, and the Down button to decrease the operation value.

F	Run button 	Run button 	When the run/stop function is controlled by the keypad, press this button and the drive will run forward. The status indicator is always on for forward running, and blinking for reverse running.
	Stop/Reset button 	Stop/Reset button 	When the given command channel is controlled by keypad, press this button to stop the drive; you can define whether other command channels are valid through the parameter [F11.03]; press this button in the fault state to reset the drive.
G			Digital potentiometer: Turn clockwise to increase the operating value; turn counterclockwise to decrease the operating value. OK button: Press this button after modifying the value to confirm the modification.
		Left shift and right shift buttons 	Move the operating position leftward and rightward.
H		Jog/Reverse 	Select the function of this button by parameter [F11.02].





- Digit/Text comparison table

Table 4-1: Digit/Text comparison table

Word	LED display	Word	LED display	Word	LED display
0		C		O	
1		D		P	
2		E		Q	
3		F		R	
4		G		S	
5		H		T	
6		I		U	
7		J		V	
8		K		W	
9		L		X	No display
A		M		Y	
B		N		Z	No display

4.3 LED Status Indicator Lights

In the table below,  indicates that the light is on,  indicates that the light is off, and  indicates that the light is blinking

Running indicator	RUN 	Off: Stop status.
	RUN 	On: Forward running.
	RUN 	Blinking: Reverse running.
Unit indicator (Hz: Frequency A: Current V: Voltage RPM: Revolutions Per Minute %: Percentage)		On: Indicate the unit of the value monitored.
		Off: Invalid.

4.4 Keypad Operation

- Setting basic parameters

Take setting F01.22 [Acceleration time 1] = 10.00 s as an example to illustrate the basic operation of the LED Keypad.

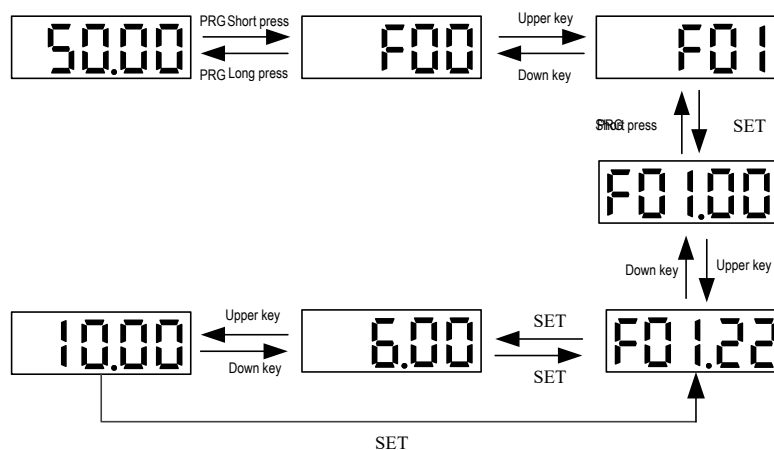

Note: Use the keypad shift buttons to quickly select the Led "00", Led "000" and Led "0000" of parameter values for modification.

- Viewing the running monitoring status

Take viewing the default monitoring state parameters as an example to illustrate the variable switching in the monitoring state.

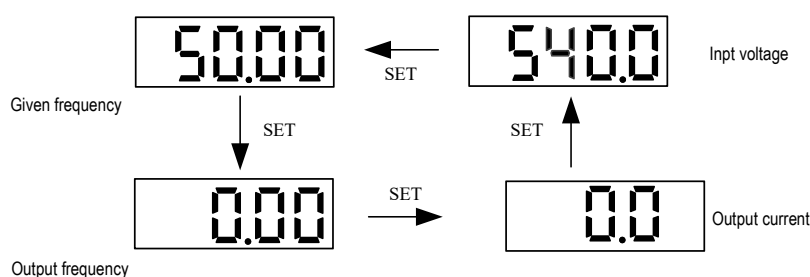

Note: For an external keypad, the left shift key is used to cycle through the first line of monitoring parameters, and the right shift key is used to cycle through the second line of monitoring parameters.

- Viewing monitoring parameters

Take viewing C02.05 [PLC running stage] as an example to illustrate the basic operation of the LED Keypad.

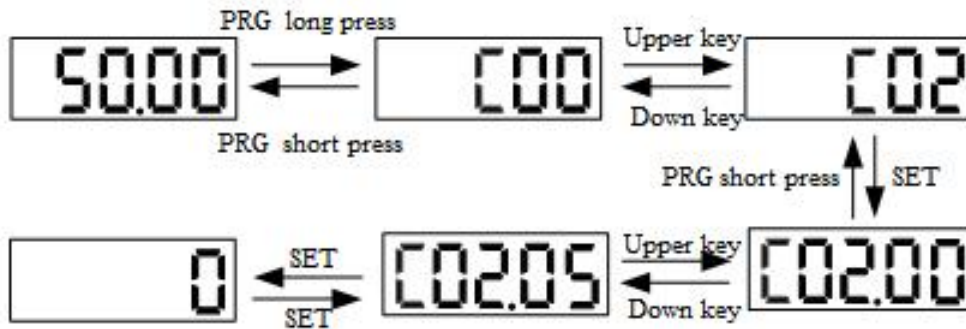

4.5 Items to Be Confirmed at Initial Start

Confirmation before power on

Before connecting the power supply, be sure to confirm the following items to ensure the safety of personnel and the drive.

Items To Be Confirmed	Related Content
Specification of input power voltage	Confirm whether the specification of input power voltage is correct. Single-phase 220 V~240V 50 Hz/60 Hz Three-phase 220 V~240V 50 Hz/60 Hz Three-phase 380 V~480 V 50 Hz/60 Hz Three-phase 660 V~690V 50 Hz/60 Hz Three-phase 1140 V 50 Hz/60 Hz
	Ensure that the power supply will not fluctuate greatly.
	Confirm that the drive and the motor are properly grounded.
Connection of drive output terminals and motor terminals	Confirm that the drive output terminals (U, V, W) are connected to the motor terminals in a proper and correct way.
Wiring of control terminals	Confirm that the control circuit terminals of the drive are connected properly and correctly.
Status of control terminals	Confirm that the signals input from the switches connected to the control circuit terminals of the drive are all disconnected.
Connection status of motor and machinery	Confirm that the motor and machinery are connected correctly and properly.

Confirmation after power on

After connecting the power supply, check whether the drive shows a fault. If the drive is normally powered on, you can follow reasonable steps, if a fault occurs, conduct troubleshooting according to the fault code, and perform related operations after troubleshooting.

4.6 Initial Start Steps

The basic initial startup steps of our drive are explained as below. For the initial use, please refer to the corresponding flowchart according to the actual situation; only the most basic settings are introduced here, and the user can operate according to the steps: Flowchart 1: Basic operation; Flowchart 2: Motor Auto-tuning operation; Flowchart 3: Vector operation optimization.

Flowchart 1

Flowchart 1 is a guide for commissioning the drive for trial operation. When the drive is commissioned for the first time, the customer can operate according to the following process. (For static Auto-tuning, change F02.07 to 2, press the RUN key, and wait for the end of learning)

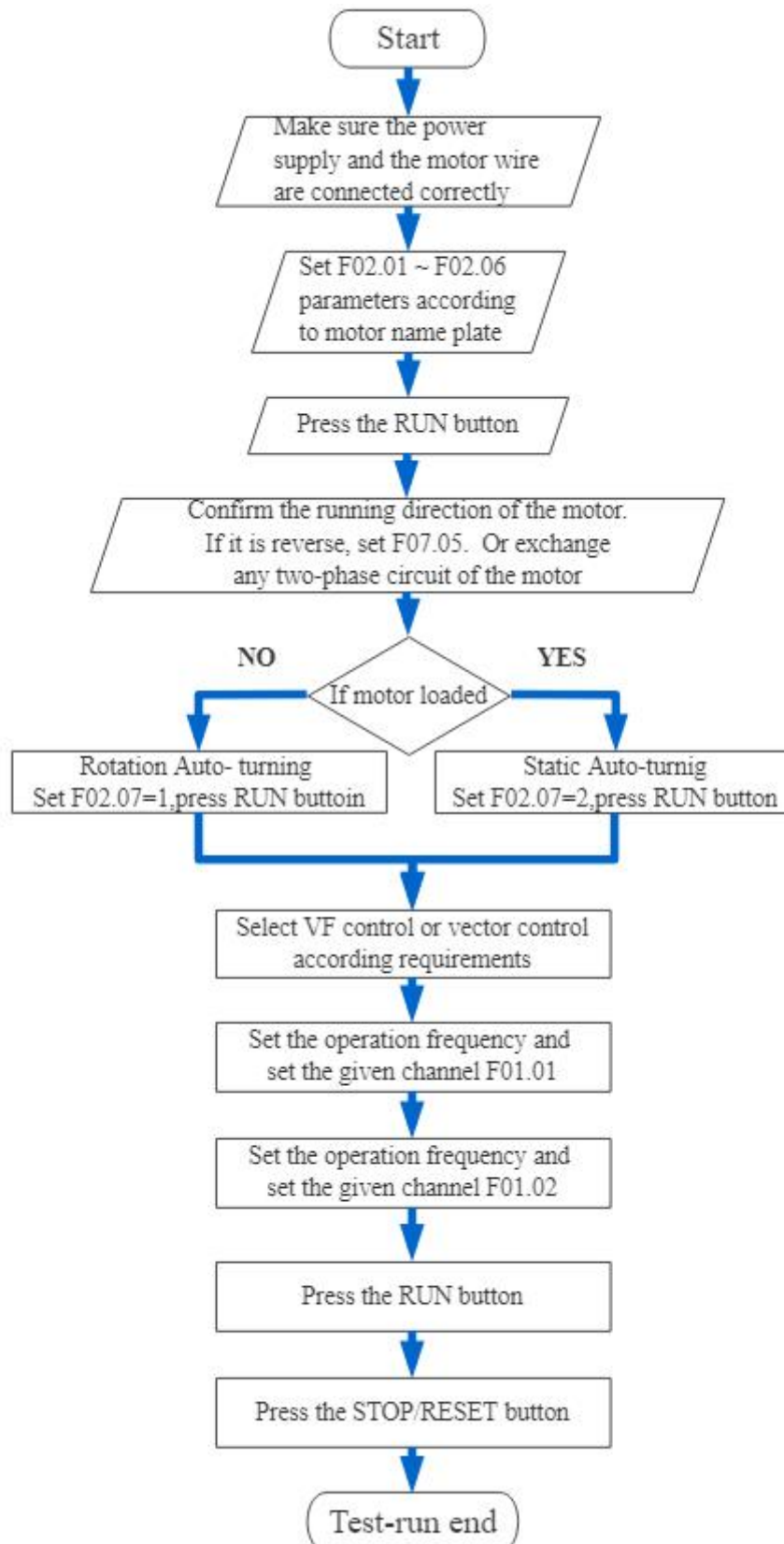

Flowchart 2

Flowchart 2 is the process of motor parameter Auto-tuning. To better control the motor for the drive, motor parameter Auto-tuning is required; (Note: the rated motor parameters must be set before Auto-tuning)

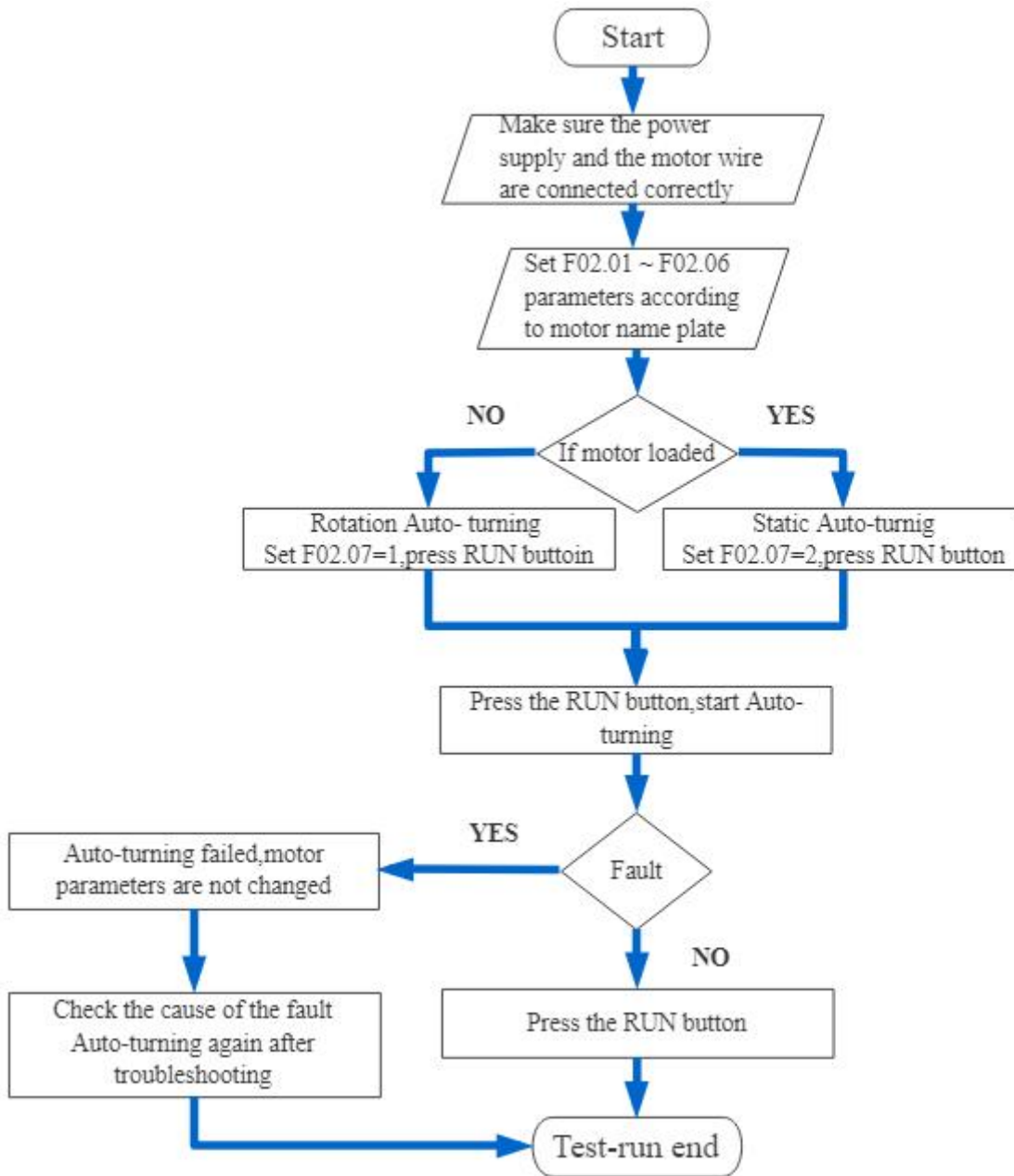

Flowchart 3

Flowchart 3 is the vector control process for debugging the vector mode, so as to achieve better drive control performance.

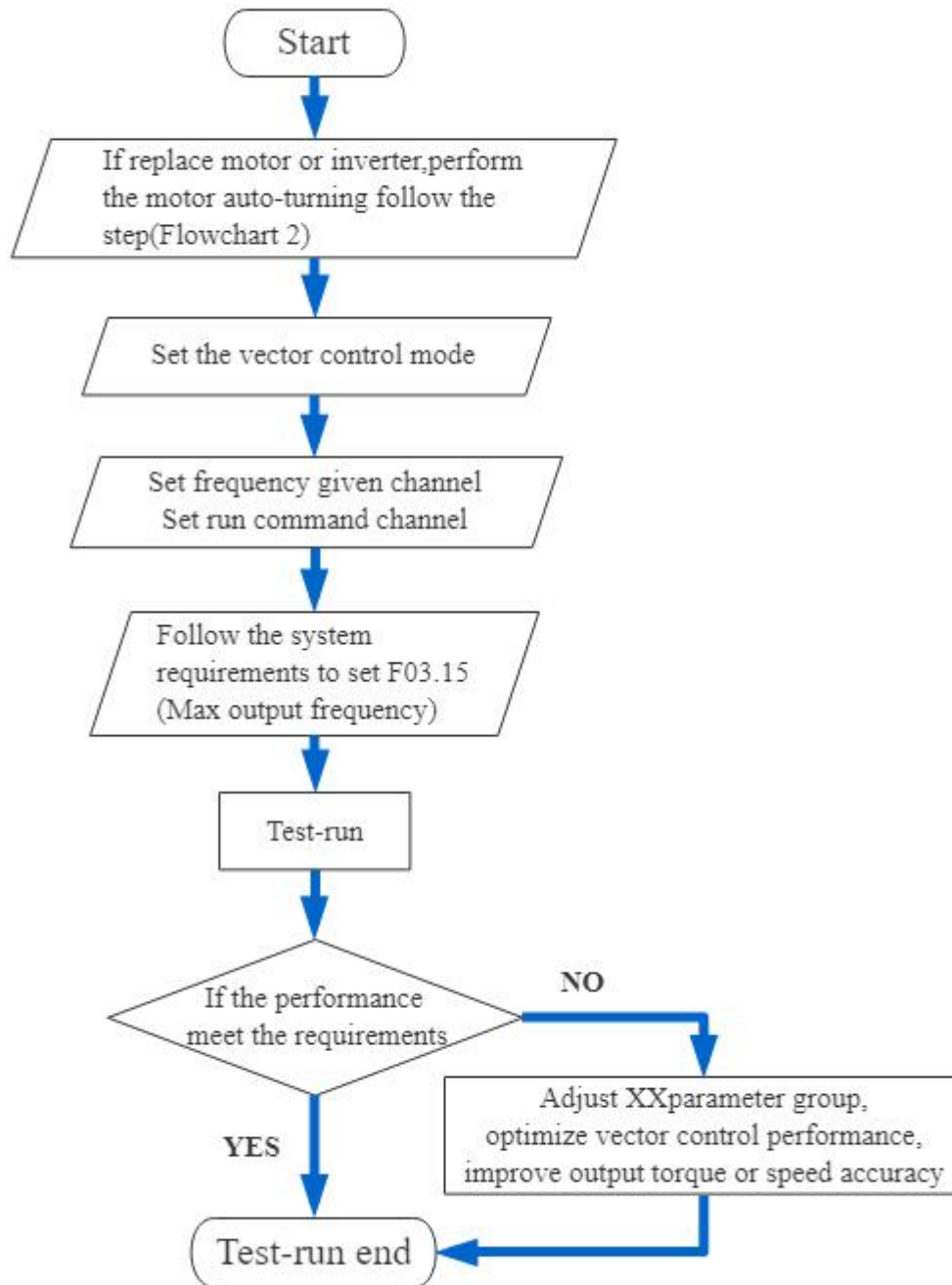

4.7 Automatic Setting of Parameters for Specific Purpose (Purpose Selection)

This product has special preset settings for certain purpose. As long as F00.01 is set for the purpose, the drive will automatically set the parameters related to the purpose to the optimal value; the purpose of this product is roughly divided into general style, fan style and water pump style; users can properly select the parameters set for the purpose according to their own needs (see F00.01 detailed parameter description) for better control performance.

4.8 Auto-tuning

Auto-Tuning is to automatically determine the motor characteristic value required for vector control and automatically set the value to the function code of the drive. The methods for the drive to obtain the internal electrical parameters of the controlled motor include: dynamic Auto-tuning, static Auto-tuning, stator resistance Auto-tuning, manual input of motor parameters, etc. Please select the most suitable Auto-tuning mode according to the type of motor used, the control mode of the drive, and the installation environment of the motor, and input the necessary parameters according to the selected Auto-tuning mode and the control mode set by F01.00.

Warning!

For mechanical safety: During rotary Auto-tuning, the motor will rotate at a speed above 50% of the rated frequency. Please confirm the surrounding safety. Otherwise, it may cause personal accidents or mechanical damage.

◆ Asynchronous motor Auto-tuning

The following describes the motor parameter Auto-tuning method for asynchronous motors. The following parameters need to be set for Auto-tuning.

- Motor parameters: F02.01 - F02.06.
- Speed feedback parameters: F2.30 - F2.38 (set for vector control with PG).

Note: Static Auto-tuning is an alternative function when rotary Auto-tuning is unavailable. Sometimes the measurement results of static Auto-tuning may have a large error with the motor characteristic parameters. Please confirm the measured motor characteristic values through the parameters after the Auto-tuning is completed.

Table 4-2: Auto-tuning mode of asynchronous motor

Parameter Setting for Auto-tuning Mode	Application Condition and Advantages	Control Mode (Set Value of F01.00)		
		V/F (0)	SVC (1)	FVC (2)
Rotary Auto-tuning (F02.07 = 1)	<ul style="list-style-type: none"> • When the motor can be separated from the mechanical load; the motor can rotate during Auto-tuning. • When running a motor with constant output characteristics. • For high-precision control, in order to obtain the highest-precision motor control, please choose rotary Auto-tuning as far as possible. • When the motor cannot be separated from the mechanical load, with the load of the motor less than 30%. 	Valid	Valid	Valid
Static Auto-tuning (F02.07 = 2)	<ul style="list-style-type: none"> • When the motor cannot be separated from the mechanical load, with the load of the motor exceeding 30%. • When the test report of the motor or the data marked on the motor nameplate cannot be obtained, the static Auto-tuning can be used to learn and measure the necessary motor data when the motor is stopped. <p>Note: When the motor load is less than 20%, the motor may rotate at a small angle during learning; the greater the power level, the longer the learning time (in minutes).</p>	Valid	Valid	Valid
Stator resistance Auto-tuning (F02.07 = 3)	<ul style="list-style-type: none"> • Auto-tuning has been performed, but after installing the motor, the wiring distance between the drive and the motor becomes more than 50 meters. • When the wiring distance under V/F control is more than 50 meters. • When the motor output is different from the drive capacity. 	Valid	Valid	Valid

■ Input data of asynchronous motor Auto-tuning

Before Auto-tuning, please confirm the test report of the motor or the data marked on the motor nameplate, and enter the items marked with ○ in the following table.

Table 4-3: Input data of asynchronous motor Auto-tuning

Parameter Name	Function Code	Unit	Rotary Auto-tuning (F02.07 = 1)	Static Auto-tuning (F02.07 = 2)	Stator Resistance Auto-tuning (F02.07 = 3)
Number of motor poles	F02.01	-	○	○	-
Rated motor power	F02.02	kW	○	○	○
Rated motor frequency	F02.03	Hz	○	○	-
Rated motor RPM	F02.04	RPM	○	○	-
Rated motor voltage	F02.05	V	○	○	○
Rated motor current	F02.06	A	○	○	○
Types of speed feedback encoder	F02.30	-	Input when F01.00 = 2 [Asynchronous motor closed-loop vector control].		
Number of ABZ encoder lines	F02.33	-			
Number of rotary transformer poles	F02.34	-			

◆ Synchronous motor Auto-tuning

The following describes the motor parameter Auto-tuning method for PM motors. The following parameters need to be set for Auto-tuning.

- Motor parameters: F02.01 - F02.06.
- Speed feedback parameters: F2.30 - F2.38 (set for vector control with PG).

Table 4-4: Auto-tuning mode of synchronous motor

Parameter Setting for Auto-tuning Mode	Application Condition and Advantages	Control Mode (Set Value of F01.00)		
		V/F (10)	SVC (11)	FVC (12)
Dynamic rotary Auto-tuning F02.07 = 1	<ul style="list-style-type: none"> • When the motor can be separated from the mechanical load; the motor can rotate during Auto-tuning. • When running a motor with constant output characteristics. • For high-precision control, in order to obtain the highest-precision motor control, please choose rotary Auto-tuning as far as possible. • When the motor cannot be separated from the mechanical load, with the load of the motor less than 30%. 	Valid	Valid	Valid
Static Auto-tuning F02.07 = 2	<ul style="list-style-type: none"> • When the motor cannot be separated from the mechanical load, with the load of the motor exceeding 30%. • When the test report of the motor or the data marked on the motor nameplate cannot be obtained, the static Auto-tuning can be used to learn and measure the necessary motor data when the motor is stopped. <p>Note: When the motor load is less than 20%, the motor may rotate at a small angle during learning; the greater the power level, the longer the learning time (in minutes).</p>	Valid	Valid	Valid
Stator resistance Auto-tuning F02.07 = 3	<ul style="list-style-type: none"> • Auto-tuning has been performed, but after installing the motor, the wiring distance between the drive and the motor becomes more than 50 meters. • When the wiring distance under V/F control is more than 50 meters. • When the motor output is different from the drive capacity. 	Valid	Valid	Valid

■ Input data of synchronous motor Auto-tuning

Table 4-5: Auto-tuning mode of synchronous motor

Parameter Name	Function Code	Unit	Rotary Auto-tuning (F02.07 = 1)	Static Auto-tuning (F02.07 = 2)	Stator Resistance Auto-tuning (F02.07 = 3)
Number of motor poles	F02.01	-	○	○	-
Rated motor power	F02.02	kW	○	○	○
Rated motor frequency	F02.03	Hz	○	○	-
Rated motor RPM	F02.04	RPM	○	○	-
Rated motor voltage	F02.05	V	○	○	○
Rated motor current	F02.06	A	○	○	○
Types of speed feedback encoder	F02.30	-	Input when F01.00 = 12 [Synchronous motor closed-loop vector control].		
Number of ABZ encoder lines	F02.33	-			
Number of rotary transformer poles	F02.34	-			

4.9 Test-Run

Set the basic parameters and start test-run after the motor Auto-tuning is completed.

Warning!

For mechanical safety: After the wiring work and parameter setting are completed, be sure to perform a test-run to make sure that the machine can operate safely; otherwise it may cause personal injury or equipment damage.

4.9.1 No-load test-run

Before connecting the motor to the machinery, please confirm the running status of the motor.

◆ Precautions before operation

Before operating the motor, please confirm the following items.

- Please confirm the safety around the motor and machinery.
- Check whether the emergency stop circuit and the safety device on the machine side are operating correctly.

◆ Items to be confirmed during operation

During operating the motor, please confirm the following items.

- Whether the motor is running forward.
- Whether the motor rotates smoothly (whether there are abnormal sounds and vibrations).
- Whether the motor accelerates and decelerates smoothly.

4.9.2 No-load test-run

The steps for the no-load test run are described below.

1. Power on the drive, and the keypad will display normally.
2. Press the PRG on the keypad to set the keypad number set frequency parameter F01.09, and set frequency to 5.00 Hz.
3. Press the RUN, the running indicator will light up, and the motor will rotate forward at 5.00 Hz.
4. Confirm that the motor rotates in the correct direction and the drive has no fault; if it shows a fault, conduct troubleshooting.
5. Increase the set frequency of the drive, press the Up/Down to change the value of F01.09, and at the same time confirm the responsiveness of the motor, while adjusting F01.09 in an amplitude of 10 Hz.
6. Every time the set value is increased, the output current of the drive must be confirmed through C00.02 (output current). It is normal if the output current of the drive does not exceed the rated current of the motor.

Example: 5.00 Hz→10.00 Hz→20.00 Hz→30.00 Hz→40.00 Hz→50.00 Hz

7. After confirming that the motor can rotate normally, press the STOP, and the running indicator will light off after the motor has completely stopped.

After confirming that there is no problem when running under no-load condition, connect the motor to the mechanical system for test run.

◆ Precautions before operation

- Please confirm the safety around the motor and machinery.
- Make sure that the motor has stopped completely.
- Please connect the motor and machinery. Please confirm whether the mounting screws are loose, and securely fix the motor shaft and the mechanical system.
- In order to prevent abnormal actions, please be prepared to press the STOP button of the manipulator at any time.

◆ Items to be confirmed during operation

- Check whether the machine runs in correct direction (whether the motor rotates in correct direction).
- Whether the motor accelerates and decelerates smoothly.

4.9.3 Test-run with load

After connecting the machinery to the motor, perform the test-run according to the same operation steps as the no-load test-run.

Please confirm whether C00.02 (output current) is too large.

1. Power on the drive, and the keypad will display normally.
2. Press the PRG on the keypad to set the keypad number set frequency parameter F01.09, and set frequency to 5.00 Hz.
3. Press the RUN, the running indicator will light up, and the motor will rotate forward at 5.00 Hz.
4. Confirm that the motor rotates in the correct direction and the drive has no fault; if it shows a fault, conduct troubleshooting.
5. Increase the set frequency of the drive, press the Up/Down to change the value of F01.09, and at the same time confirm the responsiveness of the motor, while adjusting F01.09 in an amplitude of 10 Hz.
6. Every time the set value is increased, the output current of the drive must be confirmed through C00.02 (output current). It is normal if the output current of the drive does not exceed the rated current of the motor.
Example: 5.00 Hz→10.00 Hz→20.00 Hz→30.00 Hz→40.00 Hz→50.00 Hz
7. After confirming that the motor can rotate normally, press the STOP, and the running indicator will light off after the motor has completely stopped.
8. Change the frequency command and rotation direction to confirm whether there are abnormal sounds and vibrations.
9. If there is a control failure such as imbalance or vibration, please make adjustments.

4.10 Precise Adjustment during Test-run (Optimization of Control Performance)

The following describes how to adjust control failures such as imbalance or vibration that occurs during test-run. Please adjust the corresponding parameters in the table according to the control mode used and the state of the drive.

Note: This section only lists the parameters that are frequently adjusted. If you need to make more rigorous drive adjustments, please contact us.

◆ V/F control mode

Parameters Used for Drive Fine-tuning (V/F Control Mode)

Fault	Parameter No.	Countermeasures	Default	Recommended Value
1. The electromagnetic noise of the motor is large. 2. Imbalance or vibration occurs at low speed (below 10 Hz) and medium speed (10 Hz – 40 Hz).	F01.40 [Carrier frequency]	<ul style="list-style-type: none"> When the electromagnetic noise of the motor is large, increase the carrier frequency. When imbalance or vibration occurs at low and medium speeds, decrease the carrier frequency. 	Depending on model	1.0 to upper limit
1. The torque is insufficient at low speed (below 10 Hz). 2. Imbalance or vibration.	F04.01 [Torque boost]	<ul style="list-style-type: none"> When the torque is insufficient at low speed, increase the set value. If imbalance or vibration occurs at light load, decrease the set value. 	Depending on model	0.0 to upper limit
Poor speed accuracy	F04.03 [Slip compensation gain]	<ul style="list-style-type: none"> After setting F02.06 [Rated motor current], F02.04 [Rated motor RPM], and F02.10 [Motor no-load current], please adjust F04.03 appropriately. 	0.0%	50.0% - 150.0%

◆ Vector control without PG mode

Parameters Used for Drive Fine-tuning (Vector Control without PG Mode)

Fault	Parameter No.	Countermeasures	Default	Recommended Value
1. The torque and speed response is slow. 2. Imbalance or vibration occurs at medium speed (10 Hz - 40 Hz).	F03.02 [Speed loop proportional gain 1] F03.06 [Speed loop proportional gain 2]	<ul style="list-style-type: none"> When it is necessary to improve the responsiveness of torque and speed, gradually decrease the set value by 0.05. When imbalance or vibration occurs, gradually increase the set value by 0.05. 	10.00	0.01~100.00
	F03.03 [Speed loop integral time 1] F03.07 [Speed loop integral time 2]	<ul style="list-style-type: none"> When it is necessary to improve the responsiveness of torque and speed, while confirming the responsiveness, gradually decrease the set value by 0.01. When imbalance, vibration or large rotational inertia of load occurs, while confirming the responsiveness, gradually increase the set value by 0.05. 	0.100	0.000s~6.000s
An overvoltage fault occurs at the end of acceleration, at the beginning of deceleration, or when the load changes sharply.	F03.04 [Speed loop filter time 1] F03.08 [Speed loop filter time 2]	<ul style="list-style-type: none"> When an overvoltage fault occurs, gradually increase the set value by 4 ms while confirming the responsiveness. When the response is slow, gradually decrease the set value by 2 ms while confirming the responsiveness. 	0.0ms	0.0ms~100.0ms
Poor speed accuracy	F03.23 [Slip compensation]	<ul style="list-style-type: none"> When the speed is slow, gradually increase the set value by 10%. When the speed is fast, gradually decrease the set value by 10%. 	100%	0%~250%
1. The electromagnetic noise of the motor is large. 2. Imbalance or vibration occurs at low speed (below 10 Hz).	F01.40 [Carrier frequency selection]	<ul style="list-style-type: none"> When the electromagnetic noise of the motor is large, increase the carrier frequency. When imbalance or vibration occurs at low and medium speeds, lower the carrier frequency. 	1.0kHz	1.0 kHz to upper limit

◆ Vector control with PG mode

Parameters Used for Drive Fine-tuning (Vector Control with PG Mode)

Fault	Parameter No.	Countermeasures	Default	Recommended Value
1. The torque and speed response is slow. 2. Imbalance or vibration.	<ul style="list-style-type: none"> High-speed side F03.06 [Speed loop proportional gain 2] Low-speed side F03.02 [Speed loop proportional gain 1] 	<ul style="list-style-type: none"> In case of slow torque and speed response, gradually increase the set value by 5.00. In case of offset and vibration, decrease the set value. 	10.00	0.01~100.00
	<ul style="list-style-type: none"> High-speed side F03.07 [Speed loop integral time 2] Low-speed side F03.03 [Speed loop integral time 1] 	<ul style="list-style-type: none"> In case of slow torque and speed response, decrease the set value. In case of offset and vibration, increase the set value. 	0.100s	0.000s~6.000s
The ASR proportional gain and integral time cannot be guaranteed at low speed or high speed.	<ul style="list-style-type: none"> F03.05 [ASR switching frequency of speed control 1] F03.09 [ASR switching frequency of speed control 2] 	Change the ASR proportional gain and integral time based on the output frequency.	0.0Hz	0.0 Hz - maximum output frequency
Offset and vibration.	F03.04 [Speed loop filter time 1] F03.08 [Speed loop filter time 2]	<ul style="list-style-type: none"> When the torque and speed response is slow, gradually decrease the set value by 0.010. When the mechanical rigidity is low and vibration is prone to occur, increase the set value. 	0.0ms	0.0ms~100.0ms
1. The electromagnetic noise of the motor is large. 2. Imbalance or vibration occurs at low speed (below 3 Hz).	F01.40 [Carrier frequency selection]	<ul style="list-style-type: none"> When the electromagnetic noise of the motor is large, increase the carrier frequency. When imbalance or vibration occurs at low and medium speeds, lower the carrier frequency. 	1kHz	2.0 kHz to upper limit

◆ Vector control without PG mode for PM

Parameters Used for Drive Fine-Tuning (Vector Control without PG Mode for PM)

Fault	Parameter No.	Countermeasures	Default	Recommended Value
The motor does not act according to the command.	F02 motor parameters, F02.20 - F02.29 parameters	<ul style="list-style-type: none"> Confirm the setting of F02.03 (rated motor frequency). View the parameters of the synchronous motor and confirm all the parameters related to the motor are set up correctly. 		
The torque and speed response is slow.	F03.04 [Speed loop filter time 1] F03.08 [Speed loop filter time 2]	Decrease the set value.	0.0ms	Please change gradually by 0.1.

1. Vibration occurs when the motor starts. 2. The motor stalls.	F03.20 [Low-frequency sourcing current]	Increase the set value.	20%	Gradually increase by 5.0%.
	F07.23 [DC brake current] F07.21 [DC braking time at startup]	Perform DC braking when the motor starts.	F07.23: 60.0% F07.21: 0.0s	F07.23: Adjust as needed. F07.21: 0.0 s
Excessive current is generated at high frequency.	F03.20 [High-speed sourcing current]	Decrease the set value.	10.0%	Gradually decrease the set point by 2.0%.
The motor stalls or vibrates when it is load connected and running at a certain speed.	F03.20 [Low-frequency sourcing current] F03.21 [High-frequency sourcing current]	Increase the set value.	F03.20: 20.0% F03.21: 10.0%	Gradually increase by 5.0%.
Offset and vibration.	F03.04 [Speed loop filter time 1] F03.08 [Speed loop filter time 2]	Increase the set value.	0.0	Gradually increase the value by 0.5.

◆ PM Vector Control with PG

Parameters for Fine-tuning the Drive (PM Vector Control with PG)

Fault	Parameter No.	Countermeasures	Default	Recommended Value
• Slow torque and speed response. • Offset and vibration.	• High-speed side F03.02 [High-speed proportional gain of speed loop] • Low-speed side F03.06 [Low-speed proportional gain of speed loop]	• In case of slow torque and speed response, gradually increase the set value by 5.00. • In case of offset and vibration, decrease the set value.	10.00	0.01~100.00
	• High-speed side F03.03 [High-speed integral time of speed loop] • Low-speed side F03.07 [Low-speed integral time of speed loop]	• In case of slow torque and speed response, decrease the set value. • In case of offset and vibration, increase the set value.	0.100 s	0.000s~6.000s
Speed response cannot be secured on the low-speed or high-speed side.	F03.05 [ASR switching frequency 1 of speed control] F03.09 [ASR switching frequency 2 of speed control]	Change the ASR proportional gain and integral time based on the output frequency.	0.0Hz	0.0 Hz to maximum output frequency
Offset and vibration.	F03.04 [Speed loop filter time 1] F03.08 [Speed loop filter time 2]	• When the torque and speed response is slow, gradually decrease the set value by 0.010. • When the mechanical rigidity is low and vibration is prone to occur, increase the set value.	0.0ms	0.0ms~100.0ms
Offset.	F02 Motor parameters, synchronous motor parameters	Check the test report or nameplate of the motor, and set the motor parameters	—	—

correctly.

4.11 Test-run Checklist

- Please check the following items before performing a test-run.

Check	NO.	Description
	1	Read this manual carefully before performing a test-run.
	2	Check the main circuit wiring.
	3	Power on the drive.
	4	Ensure that the input supply voltage matches the drive model.

Please check the necessary items based on the control mode.

Warning!

Safety measures when restarting the machine: Correctly wire the start/stop and safety circuits, and make sure that the machine operates properly after the drive is powered on. Failure to obey can cause personal injury from a sudden start of the machine.

- V/F Control [F01.00 = 0]

Check	NO.	Description
	5	Select the best V/F curve based on the application and motor specifications.

- Vector Control without PG [F01.00 = 1]

Check	NO.	Description
	6	Perform rotary Auto-tuning.
	7	Decouple the motor shaft from the machine before performing rotary Auto-tuning.
	8	Set the following items correctly based on the information listed on the nameplate before performing rotary Auto-tuning. <ul style="list-style-type: none"> •Number of poles •Rated output power (kW) •Rated voltage (V) •Rated current (A) •Rated frequency (Hz) •Rated speed (RPM)

- Vector Control with PG [F01.00=2]

Check	NO.	Description
	9	Perform rotary Auto-tuning.
	10	Decouple the motor shaft from the machine before performing rotary Auto-tuning. Set the following items correctly based on the information listed on the nameplate before performing rotary Auto-tuning. <ul style="list-style-type: none"> •Number of poles •Rated output power (kW) •Rated voltage (V) •Rated current (A) •Rated frequency (Hz) •Rated speed (RPM) Set F02.30 [Encoder type], F02.33 [Number of PG pulses] or F02.34 [Number of resolver poles].

- Synchronous Motor V/F Control [F01.00=10]

Check	NO.	Description
	11	Based on the application and motor specifications.

- Synchronous Motor Vector Control without PG [F01.00=11]

Check	NO.	Description
	12	Perform rotary Auto-tuning.
	13	Decouple the motor shaft from the machine before performing rotary Auto-tuning. Set the following items correctly based on the information listed on the nameplate before performing rotary Auto-tuning.

		•Number of poles •Rated voltage (V) •Rated frequency (Hz)	•Rated output power (kW) •Rated current (A) •Rated speed (RPM)
--	--	---	--

➤ Synchronous Motor Vector Control with PG [F01.00=12]

Check	NO.	Description
	14	Perform rotary Auto-tuning.
	15	Decouple the motor shaft from the machine before performing rotary Auto-tuning. Set the following items correctly based on the information listed on the nameplate before performing rotary Auto-tuning. •Number of poles •Rated output power (kW) •Rated voltage (V) • Rated current (A) •Rated frequency (Hz) • Rated speed (RPM) Set F02.30 [Encoder type], F02.33 [Number of PG pulses] or F02.34 [Number of resolver poles].

➤ After checking No.5 to 15, please check the following items.

Check	NO.	Description
	16	Make sure that the keypad displays properly when starting the run.
	17	Make sure that F01.01=0 and F01.02=0 when entering the run command and frequency command from the keypad.
	18	Exchange any two of the drive output terminals U, V, and W when the motor rotates in the wrong direction during the test-run.
	19	Set F10.55 (motor overload model) and F10.56 (motor insulation class) correctly to ensure the proper operation of motor overload protection.
	20	Make sure that F01.01=1 and F01.02=2 (VS1) when entering the run command and frequency command from the control circuit terminal.
	21	When entering the frequency command from the analog input terminal AI1: • Voltage input - Make sure that the drive DIP switch AI1 is set to terminal U. - Make sure that F01.02 = 2 [Frequency setting source channel A = terminal AI1 setting]. • Current input - Make sure that the drive DIP switch AI1 is set to terminal I. - Make sure that F01.02 = 2 [Frequency setting source channel A = terminal AI1 setting].
	22	When entering the frequency command from the analog input terminal AI2: • Voltage input - Make sure that the drive DIP switch AI2 is set to terminal U. - Make sure that F01.02 = 3 [Frequency setting source channel A = terminal AI1 setting]. • Current input - Make sure that the drive DIP switch AI2 is set to terminal I. - Make sure that F01.02 = 3 [Frequency setting source channel A = terminal AI1 setting].
	23	Make sure that the frequency command has reached the desired minimum/maximum value. If the desired value is not reached, please check the following items: Gain adjustment: Set the maximum voltage/current value and adjust the analog input gain until the frequency command reaches the desired value. (Frequency setting channel A gain: F01.03; frequency setting channel B gain: F01.05.) Bias adjustment: Set the maximum voltage/current value and adjust the analog input bias until the frequency command reaches the desired minimum value. (When entering from terminal AI1: F05.50 - F05.53; when entering from terminal AI2: F05.55 - F05.58.)

5 Network Communication

5.1 Safety Precautions

Please follow all the safety instructions in this manual.

Failure to observe the safety instructions may result in serious injury or death. The company will not be held liable for any injury or equipment damage caused by your company or your company's customers who failed to comply with the instructions in this manual.

5.2 Modbus Communication

AC310 series frequency drives are equipped as standard with RS485 communication interface and adopts the international standard Modbus communication protocol for master-slave communication. You can use PC/PLC, host computer, and master station drive to implement centralized control (setting of drive control command and operating frequency, modification of related functional code parameters, monitoring of drive working status and fault message, etc.) to meet specific application requirements.

5.2.1 Master/Slave configuration

The communication (serial communication) between the master and the slave is usually performed by the master starting communication and the slave responding. The master pre-sets the address number for each slave and specifies the number for signal communication. The slave that receives the command from the master performs the function specified by the master and responds to the master.

5.2.2 Communication rules

The Modbus communication format is shown in the table below.

Item	Description
Interface	RS-485 (RS232 interface requires an additional RS232/RS485 drive).
Synchronization	Asynchronous
Communication frame	Baud rate: 1200, 2400, 4800, 9600, 19200, 38400, 57600 bps.
	Data length: 8 bits (fixed).
	Check: odd, even, none.
	Stop bit: 1 bit (fixed).
Communication protocol	Modbus protocol (RTU mode only).

Note: The AC310 series only supports RTU mode.

5.2.3 Information format

In RTU mode, a new frame begins with a transmission time pause interval of at least 3.5 bytes. The data fields transmitted afterwards are: slave address, run command code, data and check word. After the last byte is transmitted, a transmission time interval of at least 3.5 bytes is used to indicate the end of the frame. The RTU data frame format is shown in the figure below.

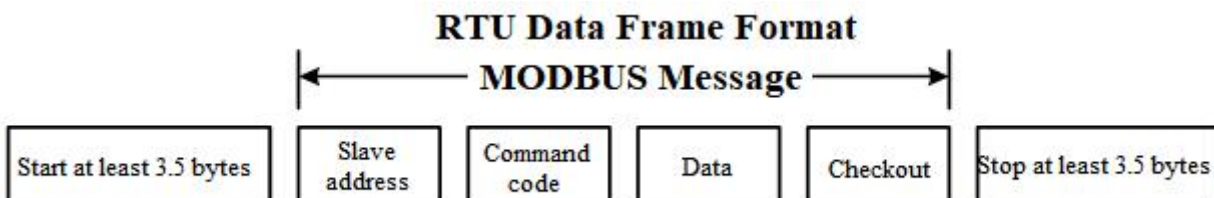

Slave Address

Please set a value from 0 to 247 (decimal). When the slave address is set to 0, the master sends the command in broadcast mode and all slaves receive the command.

For broadcast transmission, the slave station does not send a response message to the master station.

Command Code

Command Code	Function
--------------	----------

03H	Read slave parameters
06H	Write slave parameters
08H	Loop self-test

Data

The number of the drive parameter code and the data corresponding to the parameter code are combined into a series of data, including reading the data of the parameter code or specific address, writing data to the parameter code or specific address, etc.

Check

The standard Modbus communication uses two error detection methods: the parity check is used to verify each character, and the CRC check is used to verify a frame of data.

1. Parity Check

The user can configure odd or even parity, or no parity for the controller. This will determine how the parity bit in each character is set.

If odd or even parity is specified, the number of "1" will be counted into the number of bits per character (7 data bits in ASCII mode and 8 data bits in RTU mode). For example, the RTU character frame contains the following 8 data bits: 1 1 0 0 0 1 0 1, and the total number of "1" is 4.

If even parity is used, the parity bit of the frame will be 0, and the total number of "1" will still be 4. If odd parity is used, the parity bit of the frame will be 1, and the total number of "1" will be 5.

If no parity bit is specified, there will be no check bit during transmission and no parity check will be performed. One additional stop bit will be filled into the character frame in transmission.

2. CRC-16 (Cyclic Redundancy Check)

Using the RTU frame format, the frame includes a frame error detection field calculated based on the CRC method. The CRC field detects the content of the entire frame. The CRC field is two bytes and contains a 16-bit binary value. It is calculated by the transmission device and added to the frame. The receiving device recalculates the CRC of the received frame and compares it with the value in the received CRC field. If the two CRC values are not equal, it indicates that an error has occurred in the transmission.

The CRC is first stored in 0xFFFF, and then a procedure is called to process the consecutive six or more bytes in the frame with the values in the current register. Only the 8Bit data in each character is valid for CRC, and the start bit, stop bit and parity bit are invalid.

During the CRC generation process, each 8-bit character is individually XORed with the content of the register, the result moves to the least significant bit, and the most significant bit is filled with 0. The LSB is extracted for detection. If the LSB is 1, the register will be individually XORed with the preset value. If the LSB is 0, no operation will be performed. The whole process is repeated 8 times. After the last bit (bit 8) is completed, the next octet is individually XORed with the current value of the register. The value in the final register is the CRC value after all the bytes in the frame have been executed.

This CRC calculation method adopts the international standard CRC verification rule. When editing the CRC algorithm, you can refer to the CRC algorithm of the relevant standard and write a CRC calculation program that fully meets the requirements.

5.2.4 Communication command examples

Command code to read slave parameters: 03H, which reads N words. Up to 20 words can be read continuously.

For example: If the drive slave address is 01H, the memory start address is 2100H ([C00.00]), and 3 consecutive words are read, the structure of the frame will be described as follows:

RTU Master Command Information:

START	3.5 bytes of transmission time
Slave Address	01H
Command Code	03H
Start address high	21H
Start address low	00H
Data number high	00H
Data number low	03H
CRC CHK low	0FH

CRC CHK high	F7H
END	3.5 bytes of transmission time

RTU Slave Response Information (Normal):

START	3.5 bytes of transmission time
Slave Address	01H
Command Code	03H
Number of bytes low	06H
Data address 2100H high	13H
Data address 2100H low	88H
Data address 2101H high	00H
Data address 2101H low	00H
Data address 2102H high	00H
Data address 2102H low	00H
CRC CHK low	C3H
CRC CHK high	C9H
END	3.5 bytes of transmission time

RTU Slave Response Information (Abnormal):

START	3.5 bytes of transmission time
Slave Address	01H
Command Code	83H
Error code	04H
CRC CHK low	40H
CRC CHK high	F3H
END	3.5 bytes of transmission time

Command code to write slave parameters: 06H, which writes a word of data to the specified data address and is used to modify the drive parameter value.

For example: If 5000 (1388H) is written to the 3000H address of the drive with slave address 1, the structure of the frame will be described as follows:

RTU Master Command Information:

START	3.5 bytes of transmission time
Slave Address	01H
Command Code	06H
Write data address high	30H
Write data address low	00H
Data content high	13H
Data content low	88H
CRC CHK low	8BH
CRC CHK high	9CH
END	3.5 bytes of transmission time

RTU Slave Response Information (Normal):

START	3.5 bytes of transmission time
Slave Address	01H
Command Code	06H
Write data address high	30H
Write data address low	00H
Data content high	13H

Data content low	88H
CRC CHK low	8BH
CRC CHK high	9CH
END	3.5 bytes of transmission time

RTU Slave Response Information (Abnormal):

START	3.5 bytes of transmission time
Slave Address	01H
Command Code	86H
Error code	01H
CRC CHK low	83H
CRC CHK high	A0H
END	3.5 bytes of transmission time

Loop self-test command code: 06H, which returns the slave response information corresponding to the master command information and is used to detect whether the signal transmission between the master and the slave is normal. The detection code and data can be set to any value, and the detection code is independent from the parameter address of the drive.

For example: If 5000 (1388H) is written to the 0000H detection code of the drive with slave address 1, the structure of the frame will be described as follows:

RTU Master Command Information:

START	3.5 bytes of transmission time
Slave Address	01H
Command Code	08H
Detection code high	00H
Detection code low	00H
Data high	13H
Data low	88H
CRC CHK low	EDH
CRC CHK high	5DH
END	3.5 bytes of transmission time

RTU Slave Response Information (Normal):

START	3.5 bytes of transmission time
Slave Address	01H
Command Code	08H
Detection code high	00H
Detection code low	00H
Data high	13H
Data low	88H
CRC CHK low	EDH
CRC CHK high	5DH
END	3.5 bytes of transmission time

RTU Slave Response Information (Abnormal):

START	3.5 bytes of transmission time
Slave Address	01H
Command Code	88H
Error code	03H
CRC CHK low	06H
CRC CHK high	01H
END	3.5 bytes of transmission time

5.2.5 Communication data list

AC310 Series Function Parameter Address Representation Rules

The drive function parameter number serves as the register address, which is divided into two parts: high byte and low byte. The high byte indicates the group number of the function parameter, and the low byte indicates the serial number in the group of the function parameter, which needs to be converted into hexadecimal.

Definition of High Byte of Address Field:

Parameter Group Number	Parameter Address of the Group
F00 Environment application parameter group	0x00xx (not stored in EEPROM) 0x10xx (stored in EEPROM)
F01 Basic parameter group	0x01xx (not stored in EEPROM) 0x11xx (stored in EEPROM)
F02 Motor 1 parameter group	0x02xx (not stored in EEPROM) 0x12xx (stored in EEPROM)
F03 Vector control parameter group	0x03xx (not stored in EEPROM) 0x13xx (stored in EEPROM)
F04 V/F control parameter group	0x04xx (not stored in EEPROM) 0x14xx (stored in EEPROM)
F05 Input terminal parameter group	0x05xx (not stored in EEPROM) 0x15xx (stored in EEPROM)
F06 Output terminal parameter group	0x06xx (not stored in EEPROM) 0x16xx (stored in EEPROM)
F07 Operation control parameter group	0x07xx (not stored in EEPROM) 0x17xx (stored in EEPROM)
F08 Auxiliary control 1 parameter group	0x08xx (not stored in EEPROM) 0x18xx (stored in EEPROM)
F09 Auxiliary control 2 parameter group	0x09xx (not stored in EEPROM) 0x19xx (stored in EEPROM)
F10 Protection parameter group	0x0Axx (not stored in EEPROM) 0x1Axx (stored in EEPROM)
F11 Keypad parameter group	0x0Bxx (not stored in EEPROM) 0x1Bxx (stored in EEPROM)
F12 Communication parameter group	0x0Cxx (not stored in EEPROM) 0x1Cxx (stored in EEPROM)
F13 PID control parameter group	0x0Dxx (not stored in EEPROM) 0x1Dxx (stored in EEPROM)
F14 Multi-speed and simple PLC function	0x0Exx (not stored in EEPROM) 0x1Exx (stored in EEPROM)
F15 Reserved	0x0Fxx (not stored in EEPROM) 0x1Fxx (stored in EEPROM)
F16 Tension control parameter group	0x50xx (not stored in EEPROM) 0xD0xx (stored in EEPROM)
F17 Motor 2 parameter group	0x51xx (not stored in EEPROM) 0xD1xx (stored in EEPROM)
F18 Motor 2 control parameter group	0x52xx (not stored in EEPROM) 0xD2xx (stored in EEPROM)
F19 User programmable function 1	0x53xx (not stored in EEPROM) 0xD3xx (stored in EEPROM)
F20 User programmable function 2	0x54xx (not stored in EEPROM) 0xD4xx (stored in EEPROM)

F21 Industry application extension function	0x55xx (not stored in EEPROM) 0xD5xx (stored in EEPROM)
C00 Basic monitoring parameter group	0x2100
C01 Fault monitoring parameter group	0x2200
C02 Application monitoring parameter group	0x2300
C03 Maintenance monitoring parameter group	0x2400
C04 Industry application monitoring parameter group	0x2500
C05 Control monitoring parameter group	0x2600
C06 Option card monitoring parameter group A	0x2700
C07 Option card monitoring parameter group B	0x2800
Modbus communication control parameter group	0x30xx or 0x20xx
Option card communication control parameter group	0x31xx
Input/Output interface communication group	0x34xx
Cache register communication group	0x35xx
Extension fault and power-off parameter group	0x36xx

Note: Parameter values may be frequently overwritten in communication. EEPROM will have a reduced life if it is frequently written to. For users, some function code parameters do not need to be stored in the communication mode. The application requirements can be met by changing the value in the on-chip RAM. The AC310 communication protocol stipulates that when using the write command (06H), if the most significant bit of the function code parameter address field is 0, it will only be written to the drive RAM and will not be stored upon power-off. If the most significant nibble of the function code parameter address field is 1, it will be written to EEPROM and stored upon power-off.

For example: When overwriting the function parameter [F00.14], it will not be stored in EEPROM if the address is 000EH, and will be stored in EEPROM if the address is 100EH.

Descriptions of Modbus Communication Control Parameter Group Address:

Communication Address	Name	Read/Write (R/W)	Dimension (Range)	Description
0x2000 /0x3000	Set frequency	R/W	0.01Hz (0.00~320.00)	The frequency is set via communication.
0x2001 /0x3001	Command setting	R/W	0x0000 (0x0~0x0103)	0x0000: Invalid. 0x0001: Forward running 0x0002: Reverse running 0x0003: Forward jogging 0x0004: Reverse jogging 0x0005: Deceleration stop 0x0006: Free stop 0x0007: Reset command 0x0008: Run prohibition command. If 8 is written to address 3001 via communication, the drive will free stop. To allow the drive to run again, write 9 to address 3001 or power it on again. 0x0009: Run permission command. 0x0101: Equivalent to F02.07 = 1 [Rotation parameter auto-tuning], plus run command. 0x0102: Equivalent to F02.07 = 2 [Static parameter auto-tuning], plus run command. 0x0103: Equivalent to F02.07 = 3 [Stator resistance tuning], plus run command.
0x2002 /0x3002	Drive status information	R	Binary	Bit0: 0 - Stop 1 - Run Bit1: 0 - Non-acceleration 1 - Acceleration Bit2: 0 - Non-deceleration 1 - Deceleration Bit3: 0 - Forward 1 - Reverse Bit4: 0 - Normal 1 - Faulty Bit5: 0 - Unlocked 1 - Locked Bit6: 0 - No warning 1 - Warning

				Bit7: 0 - Unable to run 1 - Able to run
0x2003 /0x3003	Drive fault code	R	0 (0~127)	Communication reads the value of the fault code.
0x2004 /0x3004	Upper frequency limit	R/W	0.01Hz (0.00~320.00)	The upper frequency limit is set via communication.
0x2005 /0x3005	Torque setting	R/W	0.0% (0.0%~100.0%)	The torque set point is set via communication.
0x2006 /0x3006	Torque control forward speed limit	R/W	0.0% (0.0%~100.0%)	The torque control forward speed limit is set via communication.
0x2007 /0x3007	Torque control reverse speed limit	R/W	0.0% (0.0%~100.0%)	The torque control reverse speed limit is set via communication.
0x2008 /0x3008	PID setting	R/W	0.0% (0.0%~100.0%)	The PID set point is set via communication.
0x2009 /0x3009	PID feedback	R/W	0.0% (0.0%~100.0%)	The PID feedback value is set via communication.
0x200A /0x300A	VF separation voltage setting	R/W	0.0% (0.0%~100.0%)	An application parameter exclusive to drive power supply.
0x200B /0x300B	Tension setting	R/W	0.0 N/0 N (0 to maximum tension)	The number of decimal places depends on the hundreds digit of F16.03.
0x200C /0x300C	Roll diameter setting	R/W	0 mm (0 to maximum roll diameter)	
0x200D /0x300D	Linear speed setting	R/W	0.0 m/min (0 to maximum linear speed)	
0x200E /0x300E	Acceleration time 1	R/W	0.00s (0.00s~600.00s)	Reads and writes the value of F01.22.
0x200F /0x300F	Deceleration time 1	R/W	0.00s (0.00s~600.00s)	Reads and writes the value of F01.23.
0x2010 /0x3010	Fault warning & warning code	R	0 (0~65535)	1 to 127: fault codes; 128 to 159: warning codes; 0: No fault.
0x2011 /0x3011	Torque current component	R	0.0% (0.0%~400.0%)	An application parameter exclusive to belt machine.
0x2012 /0x3012	Torque filter time	R/W	0.000s (0.000s~6.000s)	Reads and writes the value of F03.47.
0x2013 /0x3013	Tension PID feedback	R/W	0 to 1000 (Corresponding to 100.0%)	
0x2014 /0x3014	Communication-set electric torque limit	R/W	0 to 4000 (Corresponding to 400.0%)	
0x2015 /0x3015	Communication-set power generation torque limit	R/W	0 to 4000 (Corresponding to 400.0%)	
0x2016 /0x3016	Reserved	R/W	--	Use with option cards.
0x2017 /0x3017	Reserved	R/W	--	Use with option cards.
0x2018 /0x3018	Terminal output control	W	Binary	For output terminal function, set F06.21 - F06.24 to 30 [Communication control output]. Bit0: Y terminal Bit1: Relay Bit2: Expanded Y1 Bit3: Expanded relay
0x2019 /0x3019	AO output	W	0.01 (0~100.00)	F06.01 = 18 [AO function output selection = communication output].
0x201A	Expanded AO	W	0.01	F06.11 = 18 [Expanded AO function output

/0x301A	output		(0~100.00)	selection = communication output].
0x201B /0x301B	Custom 1	R/W	0 (0~65535)	Use with host computer.
0x201C /0x301C	Custom 2	R/W	0 (0~65535)	Use with host computer.
0x201D /0x301D	Custom 3	R/W	0 (0~65535)	Use with host computer.
0x201E /0x301E	Custom 4	R/W	0 (0~65535)	Use with host computer.
0x201F /0x301F	Custom 5	R/W	0 (0~65535)	Use with host computer.



5.2.6 Error code

The fault codes of Modbus communication are shown in the table below. When a fault occurs, troubleshoot it before starting communication again.

Error Code	Description
1	Incorrect command code.
2	Reserved.
3	CRC error.
4	Illegal address.
5	Illegal data.
6	Parameters cannot be changed during operation.
7	Reserved.
8	The drive is busy (storing to EEPROM).
9	The parameter value exceeds the limit.
10	The reserved parameter cannot be changed.
11	The number of parameter bytes to read is incorrect.

6 Troubleshooting

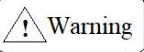
6.1 Safety Precautions

 Warning	<ul style="list-style-type: none"> • This product carries dangerous voltage and controls a moving mechanism with potential danger. Failure to follow the instructions or not complying with the requirements in this manual may result in personal injury or death, and damage to the product and associated systems. • Only trained personnel are allowed to operate this product. Before using the product, be familiar with all the safety and operating instructions in this manual. Proper operation and maintenance are required to ensure the safe and reliable operation of this product. • Do not perform wiring work while the power is on as this may cause danger of death due to electric shock. During wiring, inspection, maintenance, etc., switch off the power of all related equipment and make sure that the DC voltage of the main circuit has dropped to the safety level. Wait 5 minutes before proceeding with related operations.
 Caution	<ul style="list-style-type: none"> • Prevent children and the public from touching or approaching this product. • This product can only be used for the intended purposes specified by the manufacturer. It may not be used in special fields such as emergency, rescue, shipbuilding, healthcare, aviation, and nuclear facilities without permission. • Unauthorized modification and use of parts and accessories not sold or recommended by the manufacturer of this product may result in malfunctions.
Important	<ul style="list-style-type: none"> • Be sure to deliver this manual to the actual user to ensure that the actual user can read this manual carefully before use. • Carefully read and fully understand the safety rules and warning signs before installing and commissioning the drive.

6.2 Types of Faults, Warnings, Prompt Codes

When the drive or motor is abnormal in operation, check the code and prompt on the keypad first.

If the problem cannot be solved according to the instructions in the manual, check the following items and contact our distributor or call our service hotline (see the back cover for contact information).

1. Drive model
2. Software version
3. Date of purchase
4. Consultation details (fault conditions)

Please refer to the table below for descriptions of faults, warnings and prompts that may occur during the operation of the drive.

Table 6-1: Types of Faults, Warnings, Prompt Codes

Types	Drive Conditions When Fault Occurs
Fault	When a fault is detected, the following conditions will occur. The drive will not operate until it is restored to its normal state by a fault reset. <ul style="list-style-type: none"> • A fault message will appear on the keypad. • The drive will turn off the output and the motor will free stop. • When a fault is detected, the terminal that sets F06.21 - F06.22 = 4 [Output terminal function selection = Fault output] will turn ON. If it is not set, the terminal will not output a signal even if a fault is detected.
Warning	When a warning is detected, the following conditions will occur and no warning reset operation is required. <ul style="list-style-type: none"> • A warning message will appear on the keypad. • The drive will continue to operate. • When a warning is detected, the terminal that sets F06.21 - F06.22 = 29 [Output terminal function selection = Warning output] will turn ON. If it is not set, the terminal will not output a signal even if a warning is detected.
Prompt	<ul style="list-style-type: none"> • When power is on, "Pon" will be displayed to indicate the control board to be powered. • When the factory settings are restored, "SAVe" will be displayed. • When the Auto-tuning is set, "T-00" will be displayed to indicate the Auto-tuning state. • "CoPy" will be displayed when parameters are uploaded, and "LoAd" displayed when parameters are downloaded.

6.3 List of Faults, Warnings, Prompt Codes

Single-line keypad fault display: Refer to C01.01 for the fault subcode.



dual-line keypad fault display:

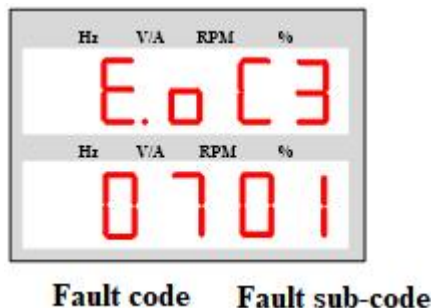

The first three digits of the dual-line keypad display are the fault code, and the last two digits are the fault sub-code.

The fault, warning and prompt codes are shown in Table 6.2. When the keypad displays the codes in the table, the detailed causes and countermeasures of the fault or warning can be found on the corresponding page of the reference source.

Note: The numbers in parentheses in the code column are fault codes or warning codes (Dec stands for decimal).

Table 6-2: List of Faults, Warnings, and Prompt Codes

Display (Dec.)	Name	Type	Reference Source (Page No.)
E. SC1 (01)	System fault during acceleration	Fault	52
E. SC2 (02)	System fault during deceleration	Fault	52
E. SC3 (03)	System fault at constant speed	Fault	53
E. SC4 (04)	System fault during stop	Fault	53
E. oC1 (05)	Over current during acceleration	Fault	57
E. oC2 (06)	Over current during deceleration	Fault	53
E. oC3 (07)	Over current at constant speed	Fault	54
E. ou1 (09)	Overvoltage during acceleration	Fault	54
E. ou2 (10)	Overvoltage during deceleration	Fault	54
E. ou3 (11)	Overvoltage at constant speed	Fault	54
E. Lu (13)	Under voltage during operation	Fault	55
E. oL1 (14)	Motor overload	Fault	55
E. oL2 (15)	Drive overload 1	Fault	55
E. oL3 (16)	Drive overload 2 CBC continuously generated	Fault	55
E. oL4 (17)	Drive overload 3	Fault	
E. iLF (18)	Input phase loss	Fault	55
E. oLF (19)	Three-phase output phase loss	Fault	56
E. oLF1 (20)	U-phase output phase loss	Fault	56
E. oLF2 (21)	V-phase output phase loss	Fault	56
E. oLF3 (22)	W-phase output phase loss	Fault	56
E. oLF4 (23)	Current imbalance	Fault	56
E. oH1 (30)	Rectifier module over-temperature	Fault	56
E. oH2 (31)	IGBT module over-temperature	Fault	56
E. oH3 (32)	Motor over-temperature	Fault	56
E. EF (33)	External fault	Fault	57
E. CE (34)	Modbus communication failure	Fault	57
E.E64	This is a self-enumeration fault	Fault	57

E. HAL1 (35)	Large U-phase zero drift	Fault	57
E. HAL2 (36)	Large V-phase zero drift	Fault	57
E. HAL (37)	Three-phase current sum is not 0	Fault	57
E. HAL3 (38)	Large W-phase zero drift	Fault	57
E. PoS (39)	Short circuit protection of internal power supply	Fault	57
E. SGxy (40)	Short circuit to ground	Fault	57
E. FSG (41)	Fan short circuit	Fault	57
E. PiD (42)	PiD feedback disconnection	Fault	58
E. CoP (43)	Parameter copy failure	Fault	58
E. PG01 (44)	PG parameter setting error	Fault	58
E. PG02 (44)	Z pulse fault	Fault	58
E. PG03 (44)	ABZ encoder disconnection	Fault	58
E. PG04 (44)	Resolver check error	Fault	58
E. PG05 (44)	Resolver disconnection	Fault	58
E. PG06 (44)	Other encoder faults	Fault	
E. PG08 (44)	Encoder Z pulse logic fault	Fault	58
E. PG10 (44)	Encoder Z pulse disconnection	Fault	58
E. PG12 (44)	Encoder feedback error	Fault	58
E. PG13 (44)	Encoder hardware disconnection	Fault	58
E. Bru (50)	braking unit fault	Fault	58
E. TExx (52)	Auto-tuning output current limit exceeded	Fault	58
E. iAE1 (71)	Motor angle learning fault 1	Fault	58
E. iAE2 (72)	Motor angle learning fault 2	Fault	58
E. iAE3 (73)	Motor angle learning fault 3	Fault	58
E. PST2 (75)	Out-of-sync fault 2	Fault	59
E. DEF (77)	Excessive speed deviation	Fault	59
E. SPD (78)	Overspeed fault	Fault	59
E. LD1 (79)	Load protection 1	Fault	59
E. LD2 (80)	Load protection 2	Fault	59
E. CPU (81)	CPU timeout failure	Fault	59
E. LoC (85)	Chip lock	Fault	59
E. EEP (86)	Parameter storage failure	Fault	59
E. PLL (87)	Phase lock loop failure	Fault	60
E. BuS1 (91)	Extension port A disconnection	Fault	60
E. BuS2 (92)	Extension port B disconnection	Fault	60
E. BuS3 (93)	CAN extension card failure	Fault	60
E. BuS4 (94)	DP extension card failure	Fault	60
E. BuS5 (95)	Other extension card failure	Fault	
E. BuS6 (96)	Other extension card disconnection	Fault	
E. CP1 (97)	Monitor comparison output 1 failure	Fault	60
E. CP2 (98)	Monitor comparison output 2 failure	Fault	60
E. DAT (99)	Parameter setting error	Fault	60
E. FA1 (110)	Reserved for external extension 1	Fault	60
E. FA2 (111)	Reserved for external extension 2	Fault	60
E. FA3 (112)	Reserved for external extension 3	Fault	60
E. FA4 (113)	Reserved for external extension 4	Fault	60
E. FA5 (114)	Reserved for external extension 5	Fault	60
E. FA6 (115)	Reserved for external extension 6	Fault	60
E. FA7 (116)	Reserved for external extension 7	Fault	60
E. FA8 (117)	Reserved for external extension 8	Fault	60

E. FrA (118)	Tension interruption fault	Fault	74
Warnings:			
A. Lu1 (128)	Undervoltage during stop	Warning	62
A. ou (129)	Overvoltage during stop	Warning	62
A. iLF (130)	Input phase loss	Warning	62
A. PiD (131)	PID feedback disconnection	Warning	62
A. EEP (132)	Parameter storage warning	Warning	62
A. DEF (133)	Excessive speed deviation	Warning	62
A. SPD (134)	Overspeed warning	Warning	63
A. GPS1 (135)	GPS locking	Warning	63
A. GPS2 (136)	GPS disconnection	Warning	63
A. CE (137)	Modbus communication disconnection warning	Warning	63
A. LD1 (138)	Load protection 1	Warning	63
A. LD2 (139)	Load protection 2	Warning	63
A. BuS (140)	Extension card disconnection warning	Warning	63
A. oH1 (141)	Module over-temperature warning	Warning	64
A. oH3 (142)	Motor over-temperature warning	Warning	64
A. run1 (143)	Run command conflict	Warning	64
A. run2 (148)	Jog terminal start protection	Warning	64
A. run3 (149)	Terminal start protection	Warning	64
A. PA2 (144)	External keypad disconnection warning	Warning	64
A. CP1 (146)	Monitor comparison output 1 warning	Warning	64
A. CP2 (147)	Monitor comparison output 2 warning	Warning	64
A. FA1 (150)	Reserved for external extension 1	Warning	64
A. FA2 (151)	Reserved for external extension 2	Warning	64
A. FA3 (152)	Reserved for external extension 3	Warning	64
A. FA4 (153)	Reserved for external extension 4	Warning	64
A. FA5 (154)	Reserved for external extension 5	Warning	64
A. FA6 (155)	Reserved for external extension 6	Warning	64
A. FrA (157)	Tension interruption warning	Warning	77
A. 161 (161)	Fan life warning	Warning	
A. 163 (163)	Relay life warning	Warning	

6.4 Faults

The drive will not function properly in case of a fault. The causes and countermeasures of faults are explained in the table below.

Note: Faults can only be fixed by the fault reset operation.

Code	Name	Cause	Countermeasures
E. SC1 (01)	System fault during acceleration	Short circuit on the output side of the drive or short circuit to ground.	Check the main circuit to eliminate the short circuit.
		The length of the drive output cable exceeds the maximum allowable value.	Shorten the output cable or increase the output reactor.
		Malfunction caused by interference.	Check the wiring of the control circuit, main circuit and grounding, and remove the source of interference.
		Motor damage.	Measure the resistance between the motor wires and replace the motor immediately if it is conductive.
		Torque boost value too large.	Reduce F04.01 [Torque boost value].
		Excessive load.	Reduce the load or replace with a high-capacity drive. Reduce the load change frequency or

			replace with a high-capacity drive for impact load.
		Acceleration time too short.	Increase F01.22 [Acceleration time 1]. Replace with a high-capacity drive.

Note: This fault will be detected in case of drive output short circuit, short circuit to ground, or IGBT module fault.

Code	Name	Cause	Countermeasures
E. SC2 (02)	System fault during deceleration	Short circuit on the output side of the drive or short circuit to ground.	Check the main circuit to eliminate the short circuit.
		The length of the drive output cable exceeds the maximum allowable value.	Shorten the output cable or increase the output reactor.
		Malfunction caused by interference.	Check the wiring of the control circuit, main circuit and grounding, and remove the source of interference.
		Motor damage.	Measure the resistance between the motor wires and replace the motor immediately if it is conductive.
		Torque boost value too large.	Reduce F04.01 [Torque boost value].
		Excessive load.	Reduce the load or replace with a high-capacity drive. Reduce the load change frequency or replace with a high-capacity drive for impact load.
		Deceleration time too short.	Increase F01.23 [Deceleration time 1]. Replace with a high-capacity drive.

Note: This fault will be detected in case of drive output short circuit, short circuit to ground, or IGBT module fault.

Code	Name	Cause	Countermeasures
E. SC3 (03)	System fault at constant speed	Short circuit on the output side of the drive or short circuit to ground.	Check the main circuit to eliminate the short circuit.
		The length of the drive output cable exceeds the maximum allowable value.	Shorten the output cable or increase the output reactor.
		Malfunction caused by interference.	Check the wiring of the control circuit, main circuit and grounding, and remove the source of interference.
		Motor damage.	Measure the resistance between the motor wires and replace the motor immediately if it is conductive.
		Torque boost value too large.	Reduce F04.01 [Torque boost value].
		Excessive load.	Reduce the load or replace with a high-capacity drive. Reduce the load change frequency or replace with a high-capacity drive for impact load.

Note: This fault will be detected in case of drive output short circuit, short circuit to ground, or IGBT module fault.

Code	Name	Cause	Countermeasures
E. SC4 (04)	System fault during stop	Short circuit on the output side of the drive or short circuit to ground.	Check the main circuit, eliminate the short circuit, and power on again.
		Malfunction caused by interference.	Check the wiring of the control circuit, main circuit and grounding, and remove the source of interference.
		Control board disturbed or damaged.	If the fault persists after power-off and restart, seek technical support.

Note: This fault will be detected in case of drive short circuit to ground or IGBT module fault.

Code	Name	Cause	Countermeasures
------	------	-------	-----------------

E. oC1 (05)	Overcurrent fault during acceleration	Excessive load.	Reduce the load or replace with a high-capacity drive. Reduce the load change frequency or replace with a high-capacity drive for impact load.
		Short circuit on the output side of the drive or short circuit to ground.	Check the main circuit to eliminate the short circuit.
		Motor damage.	Measure the resistance between the motor wires and replace the motor immediately if it is conductive.
		Acceleration time too short.	Increase F01.22 [Acceleration time 1]. Replace with a high-capacity drive.
		This may occur during frequency upconversion for overvoltage suppression.	Reduce F10.13 [overvoltage suppression gain].
		The length of the drive output cable exceeds the maximum allowable value.	Shorten the output cable or increase the output reactor.
		Malfunction caused by interference.	Check the wiring of the control circuit, main circuit and grounding, and remove the source of interference.
Note: This fault will be detected when the drive output current exceeds the overcurrent point.			
Code	Name	Cause	Countermeasures
E. oC2 (06)	Overcurrent fault during deceleration	Excessive load.	Reduce the load or replace with a high-capacity drive. Reduce the load change frequency or replace with a high-capacity drive for impact load.
		Short circuit on the output side of the drive or short circuit to ground.	Check the main circuit to eliminate the short circuit.
		Motor damage.	Measure the resistance between the motor wires and replace the motor immediately if it is conductive.
		Deceleration time too short.	Increase F01.23 [Deceleration time 1]. Replace with a high-capacity drive.
		This may occur during frequency downconversion for overcurrent suppression.	Increase F10.02 [Overcurrent suppression gain] and reduce the load.
		The length of the drive output cable exceeds the maximum allowable value.	Shorten the output cable or increase the output reactor.
		Malfunction caused by interference.	Check the wiring of the control circuit, main circuit and grounding, and remove the source of interference.
Note: This fault will be detected when the drive output current exceeds the overcurrent point.			
Code	Name	Cause	Countermeasures
E. oC3 (07)	Overcurrent fault at constant speed	Excessive load.	Reduce the load or replace with a high-capacity drive. Reduce the load change frequency or replace with a high-capacity drive for impact load.
		Short circuit on the output side of the drive or short circuit to ground.	Check the main circuit to eliminate the short circuit.
		Motor damage.	Measure the resistance between the motor wires and replace the motor immediately if it is conductive.
		The length of the drive output cable exceeds the maximum allowable value.	Shorten the output cable or increase the output reactor.

		Malfunction caused by interference.	Check the wiring of the control circuit, main circuit and grounding, and remove the source of interference.
Note: This fault will be detected when the drive output current exceeds the overcurrent point.			
Code	Name	Cause	Countermeasures
E. ou1 (09)	Overvoltage fault during acceleration	Supply voltage too high.	Reduce the supply voltage to a value within the specified range.
		Drive output short circuit or motor short circuit to ground.	Check the main circuit wiring and eliminate the short circuit.
		Acceleration time too short.	Check if the fault is detected when the sudden acceleration stops. Increase F01.22 [Acceleration time 1].
		This may occur during frequency upconversion for overvoltage suppression.	Increase F10.13 [overvoltage suppression gain].
		Brake load high.	Use a brake resistor.
		Surge voltage in the input voltage.	Add a reactor on the input side.
		Improper setting of speed tracking parameters.	Change the speed tracking parameters (F07.25 to F07.28).
Note: This fault will be detected when the bus voltage exceeds the overvoltage point. The overvoltage point is 820V for three-phase input and 400V for single-phase input.			
Code	Name	Cause	Countermeasures
E. ou2 (10)	Overvoltage fault during deceleration	Supply voltage too high.	Reduce the supply voltage to a value within the specified range.
		Drive output short circuit or motor short circuit to ground.	Check the main circuit wiring and eliminate the short circuit.
		Deceleration time too short.	Increase F01.23 [Deceleration time 1]. Use a brake resistor.
		This may occur during frequency downconversion for overcurrent suppression.	Reduce F10.02 [Overcurrent suppression gain] and reduce the load.
		Brake load high.	Use a brake resistor.
		Surge voltage in the input voltage.	Add a reactor on the input side.
		Improper setting of speed tracking parameters.	Change the speed tracking parameters (F07.25 to F07.28).
Note: This fault will be detected when the bus voltage exceeds the overvoltage point. The overvoltage point is 820V for the T3 model and 400V for the S2/T2 model.			
Code	Name	Cause	Countermeasures
E. ou3 (11)	Overvoltage fault at constant speed	Supply voltage too high.	Reduce the supply voltage to a value within the specified range.
		Drive output short circuit or motor short circuit to ground.	Check the main circuit wiring and eliminate the short circuit.
		Brake load high.	Use a brake resistor.
		Surge voltage in the input voltage.	Add a reactor on the input side.
		Improper setting of speed tracking parameters.	Change the speed tracking parameters (F07.25 to F07.28).
Note: This fault will be detected when the bus voltage exceeds the overvoltage point. The overvoltage point is 820V for three-phase input and 400V for single-phase input.			
Code	Name	Cause	Countermeasures
E. ou4	Overvoltage fault during stop	Supply voltage too high.	Reduce the supply voltage to a value within the specified range.
		Drive output short circuit or motor short circuit to ground.	Check the main circuit wiring and eliminate the short circuit.
		Surge voltage in the input voltage.	Add a reactor on the input side.

Note: This fault will be detected when the bus voltage exceeds the overvoltage point. The overvoltage point is 820V for three-phase input and 400V for single-phase input.			
Code	Name	Cause	Countermeasures
E. Lu (13)	Undervoltage during operation	Power-off or instantaneous power-off.	Reset and restart the power supply after checking.
		Input supply phase loss.	Check the main circuit wiring.
		Excessive input voltage fluctuation.	Improve the power supply to meet the rated voltage of the drive. If there is no problem with the main circuit power supply, check whether the electromagnetic contactor works properly on the main circuit side.
Note: This fault will be detected when the bus voltage is lower than the undervoltage protection point (F10.19) while the drive is running.			
Code	Name	Cause	Countermeasures
E. oL1 (14)	Motor overload	Excessive load.	Reduce the load. Properly increase the coefficient of the motor overload protection curve.
		Acceleration or deceleration time too short.	Increase F01.22 [Acceleration time] or F01.23 [Deceleration time].
		Torque boost value too large.	Reduce F04.01 [Torque boost value].
		Improper V/F curve setting.	Check the relationship between the voltage and frequency set by the V/F curve, and change F04.00 [V/F curve setting]. If you use a custom V/F curve, change the parameters related to the custom V/F curve (F04.10 to F04.19).
		Inconsistent characteristics of electronic thermal relay and motor load.	Use an external thermal relay.
		Abnormal output current caused by input phase loss.	Check the main circuit to eliminate the input phase loss.
Code	Name	Cause	Countermeasures
E. oL2 (15)	Drive overload 1	Excessive load.	Reduce the load. Properly increase the coefficient of the motor overload protection curve.
		Acceleration or deceleration time too short.	Increase F01.22 [Acceleration time] or F01.23 [Deceleration time].
		Torque boost value too large.	Reduce F04.01 [Torque boost value].
		Improper V/F curve setting.	Check the relationship between the voltage and frequency set by the V/F curve, and change F04.00 [V/F curve setting]. If you use a custom V/F curve, change the parameters related to the custom V/F curve (F04.10 to F04.19).
		Abnormal output current caused by input phase loss.	Check the main circuit to eliminate the input phase loss.
Code	Name	Cause	Countermeasures
E. oL3 (16)	Drive overload 2 (CBC)	Excessive load.	Reduce the load. Properly increase the coefficient of the motor overload protection curve.
		Acceleration or deceleration time too short.	Increase F01.22 [Acceleration time] or F01.23 [Deceleration time].
		Torque boost value too large.	Reduce F04.01 [Torque boost value].
		Improper V/F curve setting.	Check the relationship between the voltage and frequency set by the V/F curve, and

			change F04.00 [VF curve setting]. If you use a custom V/F curve, change the parameters related to the custom V/F curve (F04.10 to F04.19).
		Abnormal output current caused by input phase loss.	Check the main circuit to eliminate the input phase loss.
Code	Name	Cause	Countermeasures
E. iLF (18)	Input phase loss	Loose terminal wiring of the main circuit of drive.	After tightening the screws, power on again to start.
		Excessive input voltage fluctuation.	Improve the power supply to meet the rated voltage of the drive. If there is no problem with the main circuit power supply, check whether the electromagnetic contactor works properly on the main circuit side.
		The three-phase voltage is unbalanced.	Confirm whether there is a problem with the input voltage, and improve the power imbalance.
Note: The input phase loss detection function can be enabled or disabled with the tens digit of F10.20 [Input/Output phase loss protection selection].			
Code	Name	Cause	Countermeasures
E. oLF (19)	All output phase loss	Two-phase and above disconnection on the output side of the drive.	Check if the three-phase wiring of the motor is normal. Check if the drive output terminal screw is loose.
		Motor damage.	Measure the resistance between the motor wires and replace the motor immediately if it is conductive.
		Motor power too small.	Reset the power of drive or motor.
Note: The output phase loss detection function can be enabled or disabled with the ones digit of F10.20 [Input/Output phase loss protection selection].			
Code	Name	Cause	Countermeasures
E. oLF1 (20)	U-phase output phase loss	U phase disconnection on the output side of the drive.	Check if the U phase wiring of the motor is normal. Check if the drive output terminal screw is loose.
		Motor damage.	Measure the resistance between the motor wires and replace the motor immediately if it is conductive.
		Motor power too small.	Reset the power of drive or motor.
Code	Name	Cause	Countermeasures
E. oLF2 (21)	V-phase output phase loss	V phase disconnection on the output side of the drive.	Check if the V phase wiring of the motor is normal. Check if the drive output terminal screw is loose.
		Motor damage.	Measure the resistance between the motor wires and replace the motor immediately if it is conductive.
		Motor power too small.	Reset the power of drive or motor.
Code	Name	Cause	Countermeasures
E. oLF3 (22)	W-phase output phase	W phase disconnection on the output side of the drive.	Check if the W phase wiring of the motor is normal. Check if the drive output terminal screw is

	loss		loose.
		Motor damage.	Measure the resistance between the motor wires and replace the motor immediately if it is conductive.
		Motor power too small.	Reset the power of drive or motor.
Code	Name	Cause	Countermeasures
E. oLF4 (23)	Current imbalance	Wiring phase loss on the output side of the drive.	Check if the output wiring of the drive is broken or loose.
		Output circuit fault.	Replace the circuit board or drive.
		Three-phase imbalance of motor impedance.	Measure the resistance between the motor wires to check for three-phase deviation or disconnection.
		Current imbalance judgment threshold too small.	Increase F10.05 [Current imbalance judgment threshold].
Note: In case of one-to-many configurations, drive will perform fault protection if there is one or two phase loss in the motor.			
Code	Name	Cause	Countermeasures
E. oH1 (30)	Rectifier module overheat	Ambient temperature too high.	Reduce the ambient temperature of the drive.
		Excessive load.	Reduce the load.
		Fan fault.	Confirm whether the fan is running normally. If the fan is abnormal, replace the fan before powering on and starting.
Code	Name	Cause	Countermeasures
E. oH2 (31)	IGBT module overheat	Ambient temperature too high.	Reduce the ambient temperature of the drive.
		Excessive load.	Reduce the load. Reduce F01.40 [Carrier set point].
		Fan fault.	Confirm whether the fan is running normally. If the fan is abnormal, replace the fan before powering on and starting.
Code	Name	Cause	Countermeasures
E. oH3 (32)	Motor overheat	Motor heat dissipation abnormal.	Improve motor heat dissipation.
		Excessive load.	Reduce the load.
Note: An IO extension card is required to enable this function. This fault will be reported when the motor temperature exceeds F10.27 [Motor overheat warning detection level]. The temperature sensor to be used (PT1000/KTY84) can be selected with the ones digit of F10.26 [Motor overheat protection selection], and the motor action upon detection of this fault can be set with the tens digit of F10.26 [Motor overheat protection selection].			
Code	Name	Cause	Countermeasures
E. EF (33)	External fault	External fault signal input by the multi-function input terminal.	Eliminate external faults. Disable the external fault function of the multi-function input terminal.
Note: The external fault detection can be realized by configuring any X terminal with F05.00 to F05.09.			
Code	Name	Cause	Countermeasures
E. CE (34)	Modbus communication failure	Communication cable fault, such as short circuit, disconnection, etc.	Check whether the communication connection is normal.
		The communication data is abnormal due to interference.	Check whether the grounding wire of the whole machine is normal. Change the shielded communication cable.
Note: This fault will be reported when the communication data is incorrect and the time set in F12.06 [Modbus communication timeout time] is exceeded. The motor action upon detection of this fault can be set with F12.07 [Communication disconnection processing].			
Code	Name	Cause	Countermeasures

E.E64	This is a self-enumeration fault	1、 No motor connected for self-learning, 2、 motor parameters input error	1、 please connect the motor 2、 please re-enter the correct motor parameters
Code	Name	Cause	Countermeasures
E. HAL1 (35)	Large U-phase zero drift	Abnormal U-phase current detection signal caused by interference.	Check the grounding of the drive and eliminate the U-phase Hall interference source.
		Drive hardware abnormal.	Seek technical support from the manufacturer.
Code	Name	Cause	Countermeasures
E. HAL2 (36)	Large V-phase zero drift	Abnormal V-phase current detection signal caused by interference.	Check the grounding of the drive and eliminate the V-phase Hall interference source.
		Drive hardware abnormal.	Seek technical support from the manufacturer.
Code	Name	Cause	Countermeasures
E. HAL (37)	Three-phase current detection fault	Abnormal phase current detection signal caused by interference.	Check the grounding of the drive and eliminate the interference source.
		Short circuit between motor phases.	Check the motor wiring and power on again.
		Loose screw on the drive output terminal.	Power on the drive again after tightening the screws.
		Drive hardware abnormal.	Seek technical support from the manufacturer.
Code	Name	Cause	Countermeasures
E. HAL3 (38)	Large W-phase zero drift	Abnormal W-phase current detection signal caused by interference.	Check the grounding of the drive and eliminate the W-phase Hall interference source.
		Drive hardware abnormal.	Seek technical support from the manufacturer.
Code	Name	Cause	Countermeasures
E. PoS (39)	Internal power supply short circuit	Power board short circuit caused by dust.	Clean the dust inside the machine.
		Aging power board components.	Replace the power board.
Note: This fault occurs for T3 models within the power range of 45-110 kW.			
Code	Name	Cause	Countermeasures
E. SGxy (40)	Output short circuit to ground	Motor burned or insulation aging.	Measure the resistance between the motor wires, and replace the motor if it is conductive or the insulation is degraded.
		The distributed capacitance between the output cable and the ground terminal is large, resulting in large leakage current.	Reduce the carrier frequency if the cable length exceeds 100 m.
		Drive hardware fault.	Seek technical support from the manufacturer.
<p>Note: The phase short-circuited to ground can be determined based on the fault subcode "xy". A value less than 16 indicates U-phase short circuit to ground. A value less than 32 indicates V-phase short circuit to ground. Otherwise, it indicates W-phase short circuit to ground. A manual reset will not eliminate the fault. Please perform troubleshooting, and power off and restart the drive. You can subtract 16 from the fault subcode "xy" until the tens digit is 0, and use the ones digit to further determine the cause of the fault:</p> <p>"y" = 1 indicates that the fault is caused by a system fault; "y" = 2 indicates overcurrent; "y" = 4 indicates drive overload 2; "y" = 8 indicates overvoltage; and troubleshooting can be performed accordingly.</p>			
Code	Name	Cause	Countermeasures
E. FSG (41)	Fan short circuit to ground	Drive cooling fan damaged.	If the fault persists after power-off and restart, seek technical support from the manufacturer.

Note: A manual reset will not eliminate the fault. Please perform troubleshooting, and power off and restart the drive.			
Code	Name	Cause	Countermeasures
E. PiD (42)	PID feedback disconnection fault	Improper setting of PID disconnection detection parameters.	Adjust F13.27 [disconnection detection upper limit], F13.28 [disconnection detection lower limit], and F13.26 [disconnection detection time].
		Improper wiring of PID feedback.	Check if the PID feedback wiring is normal.
		The sensor for PID feedback is faulty.	Confirm whether the sensor is abnormal.
		The PID feedback loop of the drive control board is abnormal.	Seek technical support from the manufacturer.
Note: This fault will be reported when the PID feedback input is out of the range set by F13.27 [disconnection detection upper limit] and F13.28 [disconnection detection lower limit] and the set point of F13.26 [disconnection detection time] is exceeded. The motor action upon detection of this fault can be set with F13.25 [PID feedback disconnection processing].			
Code	Name	Cause	Countermeasures
E. CoP (43)	Parameter copy failure	Communication failure.	Check if the wiring between the keypad and the drive is normal, and re-copy after plugging and unplugging.
		The drive model or software version does not match the parameters stored in the keypad.	Copy the parameters again and download them to the drive.
		Fault with the hardware for copying the keypad parameters.	If the fault persists after the keypad is replaced, seek technical support from the manufacturer.
Code	Name	Cause	Countermeasures
E. PG01 (44)	PG parameter setting error	Improper setting of encoder transmission ratio.	Re-set F02.35 [Transmission ratio numerator] and F02.36 [Transmission ratio denominator] and make sure that their ratio is within the range of 0.01-100.
Code	Name	Cause	Countermeasures
E. PG02 (44)	Z pulse fault	Improper wiring or disconnection of ABZ encoder.	Check if the encoder wiring has a problem.
Code	Name	Cause	Countermeasures
E. PG03 (44)	ABZ encoder disconnection	Improper wiring or disconnection of ABZ encoder.	Check if the encoder wiring has a problem.
		The electromagnetic brake of the motor is in the state of holding brake.	Open the brake.
Note: This fault will be reported when the ABZ encoder has no signal and the duration exceeds F02.38 [Encoder disconnection detection time].			
Code	Name	Cause	Countermeasures
E. PG04 (44)	Resolver check error	Data transmission error caused by strong interference.	Check the grounding of the whole machine and eliminate the source of interference.
		Improper wiring or disconnection of resolver card.	Check if the resolver wiring has a problem.
Code	Name	Cause	Countermeasures
E. PG05 (44)	Resolver disconnection	Improper wiring or disconnection of resolver card.	Check if the resolver wiring has a problem.
Note: This fault will be reported when the resolver has an error signal and the duration exceeds F02.38 [Encoder disconnection detection time].			
Code	Name	Cause	Countermeasures
E. PG08 (44)	Encoder Z pulse logic fault	Improper setting of the number of ABZ encoder lines.	Reset the number of ABZ encoder lines.
		Improper setting of Z pulse detection.	Reset F02.32 [ABZ encoder Z pulse detection selection].
Code	Name	Cause	Countermeasures

E. PG10 (44)	Encoder Z pulse disconnection	Improper wiring or disconnection of ABZ encoder.	Check if the ABZ encoder wiring has a problem.
Code	Name	Cause	Countermeasures
E. Bru (50)	braking unit fault	Resistance of the brake resistor too small.	Use a brake resistor with a larger resistance.
		braking unit fault.	Seek technical support from the manufacturer.
Code	Name	Cause	Countermeasures
E. TExx (52)	Auto-tuning failure	Drive output current exceeds upper or lower limit during Auto-tuning.	Check if the motor wiring is normal, and perform Auto-tuning again after reset. If the fault persists, seek technical support from the manufacturer.
Note: Refer to the fault countermeasure list for detailed diagnosis information on parameter learning faults, where "xx" is the fault subcode of Auto-tuning.			
Code	Name	Cause	Countermeasures
E. iAE	Failed to learn the initial position angle of the synchronous motor	Failed to learn the initial position angle of the synchronous motor	Check the motor parameters. Perform learning again after the motor has stopped.
Code	Name	Cause	Countermeasures
E. PST2 (75)	Out-of-sync fault	Poor motor angle control.	Check if the motor and encoder parameters are correct. Change them if necessary.
			Complete Auto-tuning again after changing the motor or encoder parameters.
			Increase F3.83 [Motor out-of-sync detection time].
Code	Name	Cause	Countermeasures
E. DEF (77)	Excessive speed deviation	Excessive load.	Reduce the load.
		Acceleration or deceleration time too short.	Increase F01.22 [Acceleration time] or F01.23 [Deceleration time].
		The speed deviation detection parameter setting is improper.	Adjust F10.41[Speed Deviation Detection Threshold] and F10.42[Speed Deviation Detection Time].
		The electromagnetic brake of the motor is in the state of holding brake.	Open the brake.
Note: This fault will be reported when the percentage of the output motor speed to F01.10 [Maximum frequency] is greater than F10.41 [Speed deviation detection threshold] and the duration exceeds F10.42 [Speed deviation detection time]. The fault detection can be enabled and the motor action upon detection of this fault can be set with F10.40 [Protection against excessive speed deviation].			
Code	Name	Cause	Countermeasures
E. SPD (78)	Overspeed fault	Improper setting of the number of motor lines of poles.	Adjust F02.33 [ABZ encoder line number] or F02.34 [Resolver pole number].
		The parameters related to overspeed detection are not set properly.	Adjust F10.44 [Overspeed Detection Threshold] and F10.45 [Overspeed Detection Time].
Note: This fault will be reported when the percentage of the output motor speed to F01.10 [Maximum frequency] is greater than F10.44 [Overspeed detection threshold] and the duration exceeds F10.45 [Overspeed detection time]. The fault detection can be enabled and the motor action upon detection of this fault can be set with F10.43 [Protection measures against overspeed].			
Code	Name	Cause	Countermeasures
E. LD1 (79)	Load warning 1	Fault on the mechanical side, such as a broken pulley belt.	Check the mechanical conditions and eliminate the cause of the fault.
		Improper setting of parameters of load	Adjust F10.33 [Load warning detection level]

		warning 1.	1] and F10.34 [Load warning detection time 1].
<p>Note: This fault will be reported when the drive output current exceeds F10.33 [Load warning detection level 1], the duration exceeds F10.34 [Load warning detection time 1], and the fault detection is enabled and motor action upon detection of this fault is set with the ones digit and tens digit of F10.32 [Load detection warning settings] to "Report the fault and free stop".</p>			
Code	Name	Cause	Countermeasures
E. LD2 (80)	Load warning 2	Fault on the mechanical side, such as a broken pulley belt.	Check the mechanical conditions and eliminate the cause of the fault.
		Load warning 2 parameter setting is improper.	Adjust F10.35 [Load warning detection level 2] and F10.36 [Load warning detection time 2].
<p>Note: This fault will be reported when the drive output current exceeds F10.35 [Load warning detection level 2], the duration exceeds F10.36 [Load warning detection time 2], and the fault detection is enabled and motor action upon detection of this fault is set with the hundreds digit and thousands digit of F10.32 [Load detection warning settings] to "Report the fault and free stop".</p>			
Code	Name	Cause	Countermeasures
E. CPU (81)	Software calculation timeout failure	Software calculation timeout caused by strong interference to the master chip.	Eliminate the interference source, power off and restart.
		Master chip hardware problem.	Seek technical support from the manufacturer.
<p>Note: A manual reset will not eliminate the fault. Please perform troubleshooting, and power off and restart the drive.</p>			
Code	Name	Cause	Countermeasures
E. LoC (85)	Chip lock failure	Software version does not match the control board.	Seek technical support from the manufacturer.
<p>Note: A manual reset will not eliminate the fault. Please perform troubleshooting, and power off and restart the drive.</p>			
Code	Name	Cause	Countermeasures
E. EEP (86)	EEPROM failure	Interference when reading and writing parameters to EEPROM.	Check and eliminate the interference source, and read and write the parameters again.
		EEPROM hardware fault.	Power off and restart the drive. If the fault persists, seek technical support from the manufacturer.
<p>Note: A manual reset will not eliminate the fault. Please perform troubleshooting, and power off and restart the drive.</p>			
Code	Name	Cause	Countermeasures
E. PLL (87)	Phase lock loop failure	CPU chip subject to strong interference.	Restart the drive. If the fault persists and cannot be reset, seek technical support from the manufacturer.
<p>Note: A manual reset will not eliminate the fault. Please perform troubleshooting, and power off and restart the drive.</p>			
Code	Name	Cause	Countermeasures
E. BuS1 (91)	Extension card A disconnection	Data transmission error caused by strong interference.	Check the grounding of the whole machine and eliminate the source of interference.
		Improper wiring or disconnection of extension card A.	Check if the extension card A wiring has a problem.
<p>Note: The action upon detection of communication disconnection between the extension card inserted into port EX-A and the drive can be set with the ones digit of F12.50 [Extension card communication disconnection processing]. "Extension card A" refers to the extension card inserted into the EX-A port, and "extension card B" refers to the extension card inserted into the EX-B port.</p>			
Code	Name	Cause	Countermeasures
E. BuS2 (92)	Extension card B disconnection	Data transmission error caused by strong interference.	Check the grounding of the whole machine and eliminate the source of interference.
		Improper wiring or disconnection of extension card B.	Check if the extension card B wiring has a problem.
<p>Note: The action upon detection of communication disconnection between the extension card inserted into port EX-B and the drive can be set with the ones digit of F12.50 [Extension card communication disconnection processing].</p>			
Code	Name	Cause	Countermeasures
E. BuS3 (93)	CAN extension	Data transmission error caused by strong interference.	Check the grounding of the whole machine and eliminate the source of interference.

	card failure	Improper wiring or disconnection of CAN extension card.	Check if the CAN extension card wiring has a problem.
Note: The action taken can be set with F12.32 [Action upon CAN master-slave disconnection = 1: Send an alarm and free stop].			
Code	Name	Cause	Countermeasures
E. BuS4 (94)	DP extension card failure	Data transmission error caused by strong interference.	Check the grounding of the whole machine and eliminate the source of interference.
		Improper wiring or disconnection of DP extension card.	Check if the DP extension card wiring has a problem.
Note: The action taken can be set with F12.32 [Action upon DP master-slave disconnection = 1: Send an alarm and free stop].			
Code	Name	Cause	Countermeasures
E. CP1 (97)	Comparison output 1 failure	The monitor value 1 set by F06.50 [Comparator 1 monitoring selection] exceeds F06.51 [Comparator 1 upper limit] or F06.52 [Comparator 1 lower limit].	Check the status of monitor value 1 and eliminate the cause of the failure.
Note: The motor action upon detection of this failure can be set with F06.54 [Comparator 1 warning settings].			
Code	Name	Cause	Countermeasures
E. CP2 (98)	Comparison output 2 failure	The monitor value 2 set by F06.55 [Comparator 2 monitoring selection] exceeds F06.56 [Comparator 2 upper limit] or F06.57 [Comparator 2 lower limit].	Check the status of monitor value 2 and eliminate the cause of the failure.
Note: The motor action upon detection of this failure can be set with F06.59 [Comparator 2 warning settings].			
Code	Name	Cause	Countermeasures
E. DAT (99)	Parameter setting error	The parameter value is set incorrectly.	Set according to the given parameter range.
Code	Name	Cause	Countermeasures
E. FAx (11x)	External extension reservation failure	For reserved faults, specific faults corresponding to special machines in different industries have different meanings.	Check the instruction manual of the special machine corresponding to the machine to confirm the specific fault.
Code	Name	Cause	Countermeasures
E. FrA (118)	Tension interruption fault	During the tension rewinding and unwinding process, the material is broken.	Confirm and eliminate the cause of the failure.

Description of Auto-tuning fault subcode

Attachment: Auto-tuning fault E. TExx detailed fault diagnosis information is shown in the following table, where 'xx' is the Auto-tuning fault subcode

Fault subcode	Fault diagnosis information	Countermeasures
1	Current saturation, Hall detection problems or excessive output current	<ol style="list-style-type: none"> 1. Check whether there is a phase-to-phase short circuit in the motor wiring. If there is an error, please connect the motor cable correctly. 2. The synchronous motor may rotate at a certain angle during the DC learning period and cause the current to be too large. Try to learn a few more times. 3. If the internal wiring of the drive is abnormal or damaged, please contact the manufacturer.
2	The current zero bias is too large.	<ol style="list-style-type: none"> 1. Check whether there is any problem with the Hall sensor. 2. If the fault has not been eliminated after repeated Auto-tuning, please contact the manufacturer.
3	The current is unbalanced.	<ol style="list-style-type: none"> 1. Check whether there is output phase loss in the motor wiring. If there is an error, please connect the motor cable correctly. 2. Measure the resistance value between the motor wires. If there is a deviation, please replace the cable.

4	The current oscillates.	<ol style="list-style-type: none"> 1. Check whether there is a phase-to-phase short circuit in the motor wiring. If there is an error, please connect the motor cable correctly. 2. Check whether the entered motor nameplate parameters are correct. If there are errors, please correct them. 3. If the set acceleration/deceleration time is too large, the current will oscillate. Reduce F01.22[Acceleration Time 1] and F01.23[Deceleration Time 1] appropriately. 4. Adjust F04.06 [Oscillation suppression gain] according to the parameter description.
5	The static learning current amplitude exceeds the limit.	<ol style="list-style-type: none"> 1. Check whether there is a phase-to-phase short circuit in the motor wiring. If there is an error, please connect the motor cable correctly. 2. Check whether the entered motor nameplate parameters are correct. If there are errors, please correct them. 3. Ensure that the rated current of the motor is less than the limit point of the output current of the drive.
6	The static learning U-phase current exceeds the limit.	Check the U-phase motor connection, whether there is a short circuit between phases or to ground, if there is an error, please connect correctly.
7	The static learning V-phase current exceeds the limit.	Check the V-phase motor connection, whether there is a short circuit between phases or to ground, if there is an error, please connect correctly.
8	The static learning W phase current exceeds the limit.	Check the W-phase motor connection, whether there is a short circuit between phases or to ground, if there is an error, please connect correctly.
9	The current continues to exceed the limit during dynamic learning.	<ol style="list-style-type: none"> 1. Check whether there is a phase-to-phase short circuit in the motor wiring. If there is an error, please connect the motor cable correctly. 2. Check whether the entered motor nameplate parameters are correct. If there are errors, please correct them. 3. Ensure that the load carried by the motor does not exceed 50% of the rated load. 4. Increase F01.22 [Acceleration Time 1] and F01.23 [Deceleration Time 1] appropriately.
10	The voltage is saturated.	<ol style="list-style-type: none"> 1. Check whether there is an open circuit in the motor wiring. If there is an error, please connect the motor cable correctly. 2. Check whether the entered motor nameplate parameters are correct. If there are errors, please correct them. 3. Shorten the motor power cable length (< 100 m) or increase the motor power cable diameter.
15	The rotor resistance is too large.	<ol style="list-style-type: none"> 1. Check whether the entered motor nameplate parameters are correct. If there are errors, please correct them. 2. Shorten the motor power cable length (< 100 m) or increase the motor power cable diameter.
16	The inductance is too large.	<ol style="list-style-type: none"> 1. Check whether the entered motor nameplate parameters are correct. If there are errors, please correct them. 2. If the fault has not been eliminated after repeated Auto-tuning, please contact the manufacturer.
40	Auto-tuning timed out.	<ol style="list-style-type: none"> 1. Check whether the entered motor nameplate parameters are correct. If there are errors, please correct them. 2. Check whether the power level of the drive is too different from the power level of the motor (> 3 levels). 3. If the fault has not been eliminated after repeated Auto-tuning, please contact the manufacturer.
41	Parameter error.	Re-enter the motor nameplate parameters correctly to ensure that the rated frequency of the motor is within the range of 10 Hz-500 Hz.
44	The rotor resistance is negative.	<ol style="list-style-type: none"> 1. Check whether the entered motor nameplate parameters are correct. If there are errors, please correct them. 2. If the fault has not been eliminated after repeated Auto-tuning,

		please contact the manufacturer.
45	The output voltage of the synchronous machine exceeds the limit.	Check whether the entered motor nameplate parameters are correct (especially whether the Keypad input rated frequency is greater than the rated frequency on motor nameplate). If there are errors, please correct them.
46	The back-EMF voltage of learning is too high.	Check whether the entered motor nameplate parameters are correct (especially whether the Keypad input rated frequency is greater than the rated frequency on motor nameplate). If there are errors, please correct them.
47	The back-EMF voltage of learning is low.	1. Check whether the entered motor nameplate parameters are correct (especially whether the Keypad input rated frequency is far less than the motor nameplate rated value). Please correct if there are errors. 2. Check whether the motor is demagnetized.
50	The direction of motor rotation is wrong.	1. Check whether the encoder line number is set correctly, please correct if there is an error. 2. Check whether the motor load is too large (> 30%). 3. Re-learn after separating the motor from the machine.
52	The sync machine did not detect the Z pulse.	1. Check whether the Z pulse wiring of the encoder is normal. 2. Check whether the encoder connection cable is poorly wired and causes excessive interference. 3. Ensure that the encoder normally output Z pulses.
53	The Z pulse deviation of the synchronous machine is too large.	1. Check whether the encoder line number is set correctly. 2. Check whether the encoder connection cable is poorly wired and causes excessive interference.
61	The maximum frequency is limited.	The set maximum frequency of the drive is less than the rated frequency of the motor. Re-set the maximum frequency and upper limit frequency of the drive and then learn again.
62	The current deviation between the drive and the motor is too large.	Check whether the power level of the drive is too different from the power level of the motor. Please ensure that the difference between the drive and the motor does not exceed 2 power levels.
90	Give a stop command in learning.	Failed to complete the parameter learning, need to learn again.
Other subcodes	Multiple failures occurred at the same time while learning.	1. Check whether the motor wiring is correct. 2. After re-wiring, the sub-code is still reported as fault after learning, please seek technical support from the manufacturer.

6.5 Warning

When a warning occurs, the drive can continue to operate. The following table explains the cause of the warning and the corresponding measures.

Note: All warnings can be automatically eliminated when the detection conditions are not met.

Code	Name	Cause	Countermeasures
A. Lu1	stop undervoltage warning	The input power supply voltage is too low.	Increase the input power supply voltage.
		The input power has a phase loss.	Confirm whether the main circuit wiring is normal.
		The wiring terminal of the input power supply is loose.	Tighten the main circuit wiring terminals.
		The main circuit capacitor of the drive is aging.	Seek technical support.
Note: When the drive is powered off, due to the longer discharge time of the capacitor voltage, it is normal for A.LU1 to appear during the power off.			
Code	Name	Cause	Countermeasures
A. ou	stop overvoltage warning	Supply voltage too high.	Reduce the supply voltage to a value within the specified range.
		Drive output short circuit or motor short circuit to ground.	Check the main circuit wiring and eliminate the short circuit.
		Surge voltage in the input voltage.	Add a reactor on the input side.
Note: This warning is detected when the bus voltage exceeds the overvoltage point. The overvoltage point is 820V for the T3 model and 400V for the S2/T2 model.			
Code	Name	Cause	Countermeasures
A. iLF	Input phase loss warning	Loose terminal wiring of the main circuit of drive.	After tightening the screws, power on again to start.
		Excessive input voltage fluctuation.	Improve the power supply to meet the rated voltage of the drive. If there is no problem with the main circuit power supply, check whether the electromagnetic contactor works properly on the main circuit side.
		The three-phase voltage is unbalanced.	Confirm whether there is a problem with the input voltage, and improve the power imbalance.
Note: Use F10.20 [Input, output phase loss protection selection] ten digits to select whether to enable the input phase loss warning detection function.			
Code	Name	Cause	Countermeasures
A. Pid	PID feedback disconnection warning	Improper setting of PID disconnection detection parameters.	Adjust F13.27 [disconnection detection upper limit], F13.28 [disconnection detection lower limit], and F13.26 [disconnection detection time].
		Improper wiring of PID feedback.	Check if the PID feedback wiring is normal.
		The sensor for PID feedback is faulty.	Confirm whether the sensor is abnormal.
		The PID feedback loop of the drive control board is abnormal.	Seek technical support from the manufacturer.
Note: This warning will be reported when the PID feedback input is out of the range set by F13.27 [disconnection detection upper limit] and F13.28 [disconnection detection lower limit] and the set point of F13.26 [disconnection detection time] is exceeded. This warning motor action can be detected by setting F13.25 [PID feedback disconnection action selection].			
Code	Name	Cause	Countermeasures
A. EEP	EEPROM read and write warning	Interference occurred during EEPROM read-write parameter operation.	Check and eliminate the interference source, and read and write the parameters again.
Code	Name	Cause	Countermeasures

A. DEF	Excessive speed deviation warning	Overloaded	Reduce the load.
		Acceleration or deceleration time too short.	Increase F01.22 [Acceleration time] or F01.23 [Deceleration time].
		The speed deviation detection parameter setting is improper.	Adjust F10.41[Speed Deviation Detection Threshold] and F10.42[Speed Deviation Detection Time].
		The electromagnetic brake of the motor is in the state of holding brake.	Open the brake.
<p>Note: This warning will be reported when the percentage of the output motor speed to F01.10 [Maximum frequency] is greater than F10.41 [Speed deviation detection threshold] and the duration exceeds F10.42 [Speed deviation detection time]. The fault detection can be enabled and the motor action upon detection of this fault can be set with F10.40 [Protection against excessive speed deviation].</p>			
Code	Name	Cause	Countermeasures
A. SPD	Overspeed warning	Improper setting of the number of motor lines of poles.	Adjust F02.33 [ABZ encoder line number] or F02.34 [Resolver pole number].
		The parameters related to overspeed detection are not set properly.	Adjust F10.44 [Overspeed Detection Threshold] and F10.45 [Overspeed Detection Time].
<p>Note: This warning will be reported when the percentage of the output motor speed to F01.10 [Maximum frequency] is greater than F10.44 [Overspeed detection threshold] and the duration exceeds F10.45 [Overspeed detection time]. The warning detection can be enabled through F10.43 [Overspeed protection action] and the motor operation mode can be set when the fault is detected.</p>			
Code	Name	Cause	Countermeasures
A. GPS1	GPS locking	The use time of the drive has reached the set time.	Seek technical support from the manufacturer.
<p>Note: A GPRS extension card is required to enable GPS.</p>			
Code	Name	Cause	Countermeasures
A. GPS2	GPS disconnection	Communication cable failure, such as short circuit, disconnection, etc.	Check whether the communication connection is normal.
		The communication data is abnormal due to interference.	Check whether the grounding wire of the whole machine is normal. Change the shielded communication cable.
<p>Note: A GPRS extension card is required to enable GPS.</p>			
Code	Name	Cause	Countermeasures
A. CE	Modbus communication warning	Communication cable fault, such as short circuit, disconnection, etc.	Check whether the communication connection is normal.
		The communication data is abnormal due to interference.	Check whether the grounding wire of the whole machine is normal. Change the shielded communication cable.
<p>Note: This warning will be reported after the communication data is incorrect and the time set in F12.06 [Modbus communication timeout time] is exceeded. The motor action when this warning is detected can be set by F12.07 [Communication disconnection processing].</p>			
Code	Name	Cause	Countermeasures
A. LD1	Load warning 1	Fault on the mechanical side, such as a broken pulley belt.	Check the mechanical conditions and eliminate the cause of the fault.
		Improper setting of parameters of load warning 1.	Adjust F10.33 [Load warning detection level 1] and F10.34 [Load warning detection time 1].
<p>Note: This warning is reported when the output current of the drive exceeds F10.33 [Load warning detection level 1], the duration exceeds F10.34 [Load warning detection time 1], the ones and tens of F10.32 [Load detection warning setting] enable the fault detection and the motor operation mode is set to Warning continues operation when the warning is detected.</p>			
Code	Name	Cause	Countermeasures
A. LD2	Load warning 2	Fault on the mechanical side, such as a broken pulley belt.	Check the mechanical conditions and eliminate the cause of the fault.

		Load warning 2 parameter setting is improper.	Adjust F10.35 [Load warning detection level 2] and F10.36 [Load warning detection time 2].
<p>Note: This fault will be reported when the drive output current exceeds F10.35 [Load warning detection level 2], the duration exceeds F10.36 [Load warning detection time 2], and the fault detection is enabled and motor action upon detection of this fault is set with the hundreds digit and thousands digit of F10.32 [Load detection warning settings] to "Warning continues operation".</p>			
Code	Name	Cause	Countermeasures
A. BuS	Extension card wire broken	Data transmission error caused by strong interference.	Check the grounding of the whole machine and eliminate the source of interference.
		Improper wiring or disconnection of extension card.	Check whether there is a problem with the extension card wiring.
<p>Note: The action upon detection of communication disconnection between the extension card inserted into port EX-A and the drive can be set with the ones digit of F12.50 [Extension card communication disconnection processing]. Note: F12.50 [Extension card communication disconnection processing]ten digits can be used to set the action after the communication disconnection between the extension card inserted into the EX-B port and the drive is detected. F12.43 [CAN master-slave disconnection action = 2: warning and continue running]. F12.32 [DP master-slave disconnection action = 2: warning and continue running].</p>			
Code	Name	Cause	Countermeasures
A. oH1	Module overheating warning	Ambient temperature too high.	Reduce the ambient temperature of the drive.
		Excessive load.	Reduce the load.
		Fan fault.	Confirm whether the fan is running normally. If the fan is abnormal, replace the fan before powering on and starting.
<p>Note: This warning will be reported when the module temperature exceeds F10.25 [Drive overheating warning detection level]. If the module temperature continues to rise, the overheating fault E. oH1 will be triggered.</p>			
Code	Name	Cause	Countermeasures
A. oH3	Motor overheating warning	Motor heat dissipation abnormal.	Improve motor heat dissipation.
		Excessive load.	Reduce the load.
<p>Note: This warning will be reported when the motor temperature exceeds F10.27 [Motor overheating pre-warning detection level]. Select which temperature sensor (PT1000/KTY84) to use by F10.26 [Motor overheat protection selection] digit, and set the motor action when this warning is detected by F10.26 [Motor overheat protection selection] decimal digits. An IO extension card is required to enable this function.</p>			
Code	Name	Cause	Countermeasures
A. run1	Run command conflict	The stop signal is valid when the run command is valid.	Remove the stop signal, including stop and emergency stop signals.
Code	Name	Cause	Countermeasures
A. run2	Jog terminal start protection	To prevent the jog terminal signal from being effective when the power is turned on and cause direct jog operation.	After removing the jog terminal command and then re-enable it, the jog operation can be performed normally.
Code	Name	Cause	Countermeasures
A. run3	Terminal start protection	To prevent the terminal start signal from being effective when the power is turned on, which leads to direct start.	After removing the terminal start command and then re-enable it, the operation can be started normally.
Code	Name	Cause	Countermeasures
A. PA2	External keypad disconnection warning	Data transmission error caused by strong interference.	Eliminate the source of interference.
		Improper wiring or disconnection of external keypad.	Check whether there is a problem with the external keypad connection, and then plug and unplug the keypad again. If the problem still cannot be solved, you can seek the manufacturer's technical support for the external keypad problem.

Note: When the external keypad disconnection warning occurs, and the keypad cannot be successfully connected after replugging and unplugging the keypad, after the warning disappears, the running command will be switched to "Built-in keypad is effective".			
Code	Name	Cause	Countermeasures
A. CP1	Comparison output 1 warning	The monitor value 1 set by F06.50 [Comparator 1 monitoring selection] exceeds F06.51 [Comparator 1 upper limit] or F06.52 [Comparator 1 lower limit].	Confirm the status of monitor value 1 and eliminate the cause of the warning.
Note: The motor operation mode can be detected through F06.54 [Comparator 1 Warning Setting] when the warning is reported.			
Code	Name	Cause	Countermeasures
A. CP2	Comparison output 2 warning	The monitor value 2 set by F06.55 [Comparator 2 monitoring selection] exceeds F06.56 [Comparator 2 upper limit] or F06.57 [Comparator 2 lower limit].	Confirm the status of monitor value 2 and eliminate the cause of the warning.
Note: The motor operation mode can be detected through F06.59 [Comparator 2 Warning Setting] when the warning is reported.			
Code	Name	Cause	Countermeasures
A. FAX	External extension reserve warning	For reserved warnings, specific warnings corresponding to special machines in different industries have different meanings.	Check the instruction manual of the special machine corresponding to the machine to confirm the specific warnings.
Code	Name	Cause	Countermeasures
A. FrA	Tension interruption warning	During the tension rewinding and unwinding process, the material is broken.	Confirm and eliminate the cause of the failure.
Code	Name	Cause	Countermeasures
A. 161	Cooling fan life warning	The service life of the cooling fan reaches 90%.	Replace the fan in time and set F09.03 [Cooling Fan Maintenance Setting] to 0.
Code	Name	Cause	Countermeasures
A. 163	Main relay life warning	The service life of the main relay reaches 90%.	Contact the manufacturer to replace the main relay.

6.6 Fault Reset Method

When the drive stops running due to a fault, follow the steps below to find out the cause, and restart the drive after taking appropriate countermeasures.

WARNING! Before performing maintenance, inspection, and component replacement of the drive, wear goggles to protect your eyes.

Warning! When the fuse is blown or the leakage circuit breaker is tripped, do not restart the drive or run external equipment within 5 minutes. Please confirm the wiring and the ratings of the external equipment to find out the cause of the trip. If you cannot find the cause, please consult the technical support department, otherwise it may cause a personal accident or drive damage.

Fault finding

1. Confirm the fault code displayed on the keypad.
2. Please refer to the chapter of fault diagnosis to eliminate the cause of the fault.

Note: 1. The fault caused this power switch-off can be verified through C01.00 [Diagnosis information of this fault]. Through C01.01 - C01.09, The status of the drive (frequency, current, voltage, etc.) can be viewed when this fault occurs.

2. Through C01.10 [Last Fault Diagnosis Information], you can confirm what fault caused the power to be switch off. Through C01.11 - C01.19 you can check the status of the drive when the last fault occurred (frequency, current, voltage, etc.).

3. Perform fault reset operation.

External fault reset

After a fault occurs, in order to restore the drive to a normal state, it is necessary to reset the fault after eliminating the cause of the fault. There are four fault reset methods, namely:

1. Press the STOP/RESET key on the keypad when a fault occurs.
2. The multi-function input terminal function selects fault reset and makes the terminal effective.
3. Send a fault reset command via communication.
4. Drive power on again.

Reset operation when multiple faults are triggered at the same time:

1. The Keypad displays the earliest fault among the faults to be reset.
2. Remove the cause of the fault according to the Keypad prompts. After resetting, the Keypad will prompt the second trigger fault. Remove the cause of the fault in turn, and reset until the fault is completely eliminated.
3. According to the fault type indicated by the fault monitoring parameter C01.xx, eliminate the cause of each fault, and reset multiple faults at one time.

6.7 Troubleshooting without Prompts on The Keypad

When the fault code or error code is not displayed on the keypad, but the drive or motor operates abnormally, please refer to this section and take appropriate countermeasures.

◆ The parameter cannot be modified, the keypad displays "- . . . -"

Cause	Countermeasures
Modify the parameters that cannot be changed while the drive is running.	Modify this parameter after stopping the drive.
Modify read-only parameters.	Read-only parameters cannot be modified.

◆ The motor does not rotate when inputting the running command

Cause	Countermeasures
Improper setting of the set channel of the run command.	Check the setting of F01.01 [Run Command Channel] and confirm the source of the run command.
Improper setting of frequency setting mode causes the given frequency to be 0.	Check the setting of F01.02 [Frequency Setting Mode] to confirm that the frequency setting source is valid.
An emergency stop signal was input.	Release the emergency stop signal.
When the terminal is used as a command channel, the terminal wiring is improper.	Confirm whether the control circuit terminal wiring is correct. Check the status of the input terminals through C00.14 [Input terminal status].
The set frequency is too low.	Check if C00.00 [Set frequency] is higher than the set point of F01.13 [Lower limit frequency].

◆ The direction of motor rotation is opposite to the running command

Cause	Countermeasures
Improper wiring of the motor cable.	Confirm whether the wiring between the drive and the motor is correct. Change the wiring of any two phases of the motor U, V, W.
The rotation direction of the motor is set incorrectly.	Confirm whether the wiring between the drive and the motor is correct. Change the ones digit of F07.05[Rotation Direction Selection] to reverse the running direction.

◆ The motor only rotates in one direction

Cause	Countermeasures
The running direction prohibition function is set.	Modify F07.05[Rotation Direction Selection] Tens digit running direction prohibition bit.

◆ The motor heats up abnormally

Cause	Countermeasures
-------	-----------------

Excessive load.	Reduce the load. Replace with a high-power motor.
Run at very low speed for a long time.	Change the running speed. Replace with a dedicated motor for the drive.
It is set to vector control mode but motor Auto-tuning is not performed.	Perform motor Auto-tuning. If possible, change the control mode to VF control.
The cooling fan of the motor was covered with too much dust, which caused the fan to block or stop.	Clean the fan of the motor. Improve the cleanliness of the use environment.

◆ **Do not run according to the set acceleration and deceleration time**

Cause	Countermeasures
Excessive load.	Reduce the load. Replace with a high-power motor.
The output current has reached the current limit.	Reduce the load. Replace with a high-power motor.
The acceleration/deceleration time is set too short.	Increase F01.22 [Acceleration time 1] or F01.23 [Deceleration time 1].
The setting of the motor characteristic parameters is improper.	Check F4.00 [V/F curve selection] to confirm whether a V/F curve that meets the characteristics of the motor is selected. Perform rotary Auto-tuning.
There is no Auto-tuning when using vector control mode.	Perform motor Auto-tuning. If possible, change the control mode to VF control.

◆ **There is a significant deviation between the motor speed and the frequency command value**

Cause	Countermeasures
The frequency command gain of the analog input and the corresponding relationship of the analog are set improperly.	Confirm whether the relevant parameter value setting of the analog input terminal is appropriate. Terminal AI1: F05.50 - F05.53 [Terminal AI1 related parameters]. Terminal AI2: F05.55 - F05.58 [Terminal AI2 related parameters].
Whether there is overlap in the setting of frequency given command source.	Check F01.07 [Frequency setting source selection] to confirm the frequency setting source.

◆ **When the motor rotates, the machine vibrates or is out of adjustment**

Cause	Countermeasures
An analog frequency command is input from the outside.	Check whether the external signal line is affected by noise. Try to isolate the main circuit wiring from the control circuit wiring, and use shielded wires or stranded wires for the signal wires of the control circuit. Increase the set point of the analog input filter time constant.
The wiring distance between the drive and the motor is too long.	Keep the wiring length as short as possible.
Insufficient adjustment of PID parameters.	Readjust F13.xx [PID control parameter group].

◆ **The output frequency cannot reach the command frequency value**

Cause	Countermeasures
The set frequency command value is just within the jump frequency range.	Adjust F07.44, F07.46 [Jump frequency 1, 2] and F07.45, F07.47 [Jump frequency range 1, 2]. Note: When the jump frequency is valid, the output frequency will not change within the range of the jump frequency.
The set frequency exceeds the set point of upper limit frequency.	Check F01.11 [Upper limit frequency source selection] and confirm the set point of upper limit frequency.

6.8 Self-learning fault sub-code description

Attachment: The detailed fault diagnosis information of self-learning fault E.TExx is shown in the following table, where "xx" is the self-learning fault sub-code

Fault sub-code	Troubleshooting information	Solutions
1	Current saturation, Hall detection problem or too much output current	Check motor wiring for phase-to-phase shorts
2	Excessive current zero bias	Check the Hall sensor for problems
3	Current imbalance	Check the motor connection, whether there is a lack of phase output
4	Current oscillation	1. Check the motor connection, whether there is a short circuit between phases 2. Check whether the input motor nameplate parameters are correct
5	Static learning current amplitude exceeds limit	1. Check the motor connection, whether there is a short circuit between phases 2. Check whether the input motor nameplate parameters are correct
6	Static learning U-phase current over limit	Check the U-phase motor connection, whether there is a phase-to-phase or to ground short circuit
7	Static learning V phase current over limit	Check the V-phase motor connection, whether there is a phase-to-phase or to ground short circuit
8	Static learning W phase current over limit	Check the W-phase motor connection, whether there is a phase-to-phase or to ground short circuit
9	Continuous current over-limit during dynamic learning	1. Check the motor connection, whether there is a short circuit between phases 2. Check whether the input motor nameplate parameters are correct
10	Voltage saturation	1. Check the motor connection, whether there is a short circuit between phases 2. Check whether the input motor nameplate parameters are correct
15	Rotor resistance is too large	Check if the input motor nameplate parameters are correct
16	Inductance is too large	Check if the input motor nameplate parameters are correct
40	Self-learning timeout	1. Check whether the input motor nameplate parameters are correct 2. Whether the motor control mode selection matches the motor
41	Parameter error	Re-enter motor nameplate parameters
43	Carrier over limit	Check if the input motor nameplate parameters are correct
44	Rotor resistance is negative	1. Check the motor connection, whether there is a short circuit between phases 2. Check whether the input motor nameplate parameters are correct
45	Synchronous machine output voltage exceeds limit	Check if the input motor nameplate parameters are correct
46	Learning counter potential voltage is high	Check that the input motor voltage rating is correct
47	Learning counter potential voltage is low	Check that the input motor voltage rating is correct
50	Motor rotation direction is wrong	1. Check whether the motor connection is correct 2. Check whether the PG card is connected correctly 3. Separate the motor from the machinery and relearn
52	Synchronizer does not detect Z pulse	Check if the PG card is connected correctly
53	Synchronizer Z pulse deviation is too large	Check if the PG card is connected correctly Check whether the PG card parameters are set correctly
61	Maximum frequency is limited	The maximum frequency of the drive set is less than the rated frequency of the motor, reset the maximum frequency of the drive and the upper limit frequency and then learn again
62	Frequency converter and motor current deviation is too large	Check whether the difference between drive power level and motor power level is too large
90	Give stop orders while studying	Failure to complete parameter learning, need to relearn
Other sub-codes	Multiple faults occur simultaneously while learning	1. Check whether the motor connection is correct 2. After rewiring learning still report the sub-code failure, seek technical support from the manufacturer

7 Inspection and Maintenance

This chapter describes the regular inspection and maintenance methods during the use of the drive, the replacement methods of cooling fans and other components, and the essentials for storage of the drive.

7.1 Safety Precautions

Danger
<p>To prevent electric shock</p> <p>Do not perform wiring, inspection or repair work while the power is on. Before starting work, be sure to switch off the power of all machines. After the power is switch off, there is still residual voltage in the capacitor inside the drive. It is necessary to confirm that the main circuit voltage has fallen to a safe level, and wait 5 minutes before performing related operations. If you neglect the operation, it may cause personal accidents.</p> <p>During the operation of the drive, please do not change the wiring, remove the wiring and option cards, or replace the cooling fan.</p> <p>When using an drive to drive a motor, even if the power to the drive is switched off, an induced voltage will be generated on the motor terminals during motor rotation, so, wait until the motor cord is disconnected or confirm that the motor is no longer rotating before performing the above operation. There is a risk of electric shock if operated incorrectly.</p>
Warning
<p>To prevent electric shock</p> <p>Do not operate with the drive cover removed, otherwise there will be a risk of electric shock.</p> <p>Be sure to operate the drive in accordance with the instruction manual with the specified cover or housing installed.</p> <p>Be sure to ground the ground terminals on the motor side, otherwise electric shock may result from human contact with the motor housing.</p> <p>Non-electrical construction professionals are not allowed to perform wiring, installation, inspection, maintenance, component replacement or repair operations, otherwise there is a danger of electric shock.</p> <p>If you are wearing loose clothing or accessories, do not work on the drive. Please take off metal objects such as watches and rings and wear loose clothes before work, otherwise there will be a risk of electric shock.</p> <p>To prevent fire</p> <p>Please tighten the terminal screws according to the tightening torque in this manual. If the tightening torque is insufficient, the connection parts may overheat and cause a fire.</p> <p>If the tightening torque exceeds the specified tightening torque, it may cause malfunction of the device, damage to the terminal blocks, or cause a fire.</p> <p>Ensure to use the correct voltage of the main circuit power supply. Before energizing, please confirm whether the rated voltage of the drive is consistent with the power supply voltage. If the main circuit power supply voltage is used incorrectly, there is a danger of fire.</p> <p>Do not make flammable materials close to the drive or attach flammable materials to the drive. Please install the drive on a flame-retardant object such as metal. Otherwise, there will be a risk of fire.</p>
Caution
<p>The heat sink of the drive will generate high temperature, please do not touch it.</p> <p>When operating the drive, please follow the steps specified in ESD prevention measures, otherwise the internal circuits of the drive may be damaged due to static electricity.</p> <p>Please do not change the circuit of the drive, otherwise it will cause damage to the drive, and the repair caused by this is not covered by our warranty, and we will not be responsible for it.</p> <p>After completing the wiring of the drive and other machines, please make sure that all of the wirings were correct. If the wiring is wrong, the drive may be damaged.</p> <p>Please confirm the direction of rotation when the motor is under no load. The wrong direction of rotation may cause personal injury or property damage.</p> <p>Do not operate a damaged machine. If the machine is obviously damaged or parts are missing, please do not connect or operate it to avoid accidents.</p>

7.2 Inspection

Electronic equipment is composed of various electronic components, etc. If the service life of the relevant components is exceeded, characteristics changes or malfunctions may occur. In order to prevent the occurrence of such failures, preventive maintenance such as daily overhaul, regular overhaul, and component replacement must be carried out.

It is recommended that the machine be inspected every 3 to 4 months after installation. The maintenance period of each machine varies with working conditions, environmental conditions and usage conditions.

In the following cases, please shorten the inspection cycle:

High temperature and high altitude environment;

Start and stop the environment frequently;

There is an environment where the AC power supply and load fluctuate greatly;

An environment with excessive vibration or shock;

Environments with dust, metal dust, salts, sulfuric acid, and chlorine elements;

Harsh preservation environment.

Please perform regular maintenance according to the maintenance item list in this chapter.

◆ Daily inspection

In order to avoid the drive function deterioration and product damage, please check and confirm the following daily items every day and carry out effective records and tracking.

Note: Do not perform wiring, inspection or repair operations while the power is on. Before starting work, be sure to switch off the power of all machines. After the power is switch off, there is still residual voltage in the capacitor inside the drive. It is necessary to confirm that the main circuit voltage has dropped to a safe level, and wait 5 minutes before performing related operations to avoid personal accidents.

Inspection Items	Inspection Content	Treatment Method
Surroundings	Whether the installation environment is suitable.	Eliminate pollution sources or improve the installation environment.
Power supply	Whether the power supply voltage meets the requirements and whether there is a lack of phase.	Correspond to the power supply according to the nameplate requirements.
Motor	Whether the motor has abnormal vibration or abnormal sound.	Confirm the connection with the machine; Tighten the screws at the connection; Do lubrication treatment.
Load condition	Whether the output current of the drive is higher than the rated value of the motor or the drive for a certain period of time.	Confirm whether it is overloaded; Confirm whether the settings of the motor parameters are correct.
Cooling system	Whether the drive and motor have abnormal heating and discoloration.	Confirm whether it is overloaded; Tighten the screws; Check whether the heat sink of the drive and the motor are dirty.
	Whether the cooling fan is working properly.	Check whether the fan is blocked or damaged.

◆ **Regular inspection**

Under normal circumstances, a regular inspection is performed every 3 months to 4 months, but it needs to be combined with the usage and working environment to consider shortening the inspection cycle. Make relevant confirmations and make effective records during the inspection.

Note: Do not perform wiring, inspection or repair operations while the power is on. Before starting work, be sure to switch off the power of all machines. After the power is switch off, there is still residual voltage in the capacitor inside the drive. It is necessary to confirm that the main circuit voltage has dropped to a safe level, and wait 5 minutes before performing related operations to avoid personal accidents.

Inspection Items	Inspection Content	Treatment Method
Overall	Check the environment to see if there is any dirt or dust.	Confirm whether the relevant cabinet doors can be closed tightly; Clean dirt or dust and improve the operating environment.
	Whether there is any discoloration due to overheating and aging; Whether there is any damage, deformation, or abnormal operation of the device.	Replace related components; If it cannot be repaired, the entire drive needs to be replaced.
Wiring	Whether the wires and their connections are discolored, damaged, or cracked.	Repair or replace wires.
Terminal block	Whether the wiring terminals are worn, damaged or loose.	Tighten the screws; Replace damaged screws or terminals.
Mechanical devices such as electromagnetic contactors, relays, etc.	Whether the wiring terminals are worn, damaged or poorly contacted; Whether the screws are loose.	Tighten the screws; Replace screws or terminals; If it cannot be replaced effectively, the drive needs to be replaced.
Diode, IGBT (power transistor)	Whether there is rubbish and dust.	Remove rubbish or dust to avoid touching any parts.
Electrolytic capacitor	Whether there is leakage, discoloration, or cracks; Whether the safety valve has arched out, whether there is a bulge, whether there is a crack or leakage.	Replace the electrolytic capacitor; If there are damaged parts that cannot be repaired or replaced, replace the entire drive.
Brake option	Whether the insulating material has changed color due to overheating.	When discoloration occurs, check whether the wiring is defective.
Printed circuit board	Whether there is a peculiar smell, discoloration or significant rust; Whether the plug is effectively connected; Whether it is stained with dust and oil.	Reconnect the plug; Replace the circuit board; Do not use solvents when cleaning the circuit board; A vacuum cleaner can be used to remove rubbish or dust to avoid touching any parts; If there are damaged parts that cannot be repaired or replaced, replace the entire drive.
Cooling fan	Whether there is abnormal vibration or abnormal sound; Whether there is damage or missing blades.	Clean or replace the fan.
Heat sink	Whether there is rubbish and dust; Whether it is dirty.	Use a vacuum cleaner to remove rubbish or dust to avoid touching any parts.
Vent	Whether the air intake and exhaust ports are blocked by foreign matters.	Remove obstructions and dust.
Keypad display	Whether the screen display is	If the screen or operation keys are defective,

	correct; Whether the operation keys are dirty.	please contact our company's agent or sales person in charge; Clean up.
--	---	--

7.3 Maintenance

All equipment and components have a service life. Proper maintenance can ensure that the service life is extended, but it cannot solve the damage of the equipment and components. Please replace the devices that have reached or are about to reach the end of their service life as required.

Note: Do not perform wiring, inspection or repair operations while the power is on. Before starting work, be sure to switch off the power of all machines. After the power is switch off, there is still residual voltage in the capacitor inside the drive. It is necessary to confirm that the main circuit voltage has dropped to a safe level, and wait 5 minutes before performing related operations to avoid personal accidents.

Component Name	Life Cycle
Fan	2 to 3 years
Electrolytic capacitor	4 to 5 years
Printed circuit board	8 to 10 years

7.4 Replacing the Cooling Fan

When replacing the cooling fan, please use the original fan. To purchase the original fan, please contact the agent where you purchased the product or the sales department of our company. There are several models equipped with multiple cooling fans in the drive. In order to maximize the service life of the product, all fans need to be replaced at the same time.

The replacement of other components requires very strict maintenance technology and product familiarity, and must undergo strict testing before being put into use after replacement. It is not recommended that users replace other internal components by themselves. If you really need to replace it, please contact the agent where you purchased the product or the sales department of our company.

Note: Do not perform wiring, inspection or repair operations while the power is on. Before starting work, be sure to switch off the power of all machines. After the power is switch off, there is still residual voltage in the capacitor inside the drive. It is necessary to confirm that the main circuit voltage has dropped to a safe level, and wait 5 minutes before performing related operations to avoid personal accidents.

7.5 Replacing the Drive

Note: Do not perform wiring, inspection or repair operations while the power is on. Before starting work, be sure to switch off the power of all machines. After the power is switch off, there is still residual voltage in the capacitor inside the drive. It is necessary to confirm that the main circuit voltage has dropped to a safe level, and wait 5 minutes before performing related operations to avoid personal accidents. Non-electrical construction professionals are not allowed to perform wiring, installation, maintenance, inspection, component replacement or repair operations. Otherwise, there is a danger of electric shock.

Notices: When operating the drive or disassembling printed circuit boards, please follow the steps specified in ESD. If the operation is wrong, the internal circuit of the drive may be damaged due to static electricity.

◆ Precautions when wiring the main circuit terminal block

- 1) Please use copper wire. Wires other than copper wires, such as aluminum wires, cannot be used.
- 2) Please be careful not to allow foreign objects to enter the wiring parts of the terminal block.
- 3) Please strip the cladding of the wire end according to the bare wire length specified in this manual.
- 4) Do not use wires that are bent or squeezed. Cut the end of the wire that was bent and deformed due to the connection before using it.
- 5) Do not solder when using stranded core wire.
- 6) When using twisted core wire, please do not make wire whiskers appear at the connection. Do not twist the stranded core wire excessively.
- 7) The wires must be inserted deeply into the terminal block. After stripping the wire end coating to the specified length, the coating can enter the resin protection hole.
- 8) The tightening torque of each terminal is different. Please tighten the screws according to the specified tightening torque.
- 9) Please use tools such as torque wrenches that match the screws. The connection of screw-type terminals requires the use of flat-head or hexagonal tools. Please refer to the recommended condition described in this manual to select tools.
- 10) When using an electric screwdriver, please pay attention to tightening at a low speed of 300r/min - 400r/min.
- 11) Wiring tools can also be purchased from our company. For details, please contact our agent or sales person in charge.

- 12) When replacing the old product with this product, the size of some of the wires in use may exceed the allowable range. Regarding the size of the wire, please consult our company's agent or sales person in charge.
- 13) When tightening the terminal screws, do not tilt more than 5°.
- 14) When tightening the slotted screw, be sure to insert the screwdriver vertically into the slotted slot of the screw, and the bit should not go out of the slot.
- 15) After wiring, gently pull the wire to confirm whether it will fall off.
- 16) Please cut only the wire cover at the terminal to be wired.
- 17) The screws of the terminal block should be re-tightened regularly according to the specified tightening torque.
- 18) If external force may be applied to the wiring, please use a clamp to increase the strength of the wiring.

7.6 Storage Instructions

Drives, like other electronic products, use electrolytic capacitors that are prone to chemical reactions, as well as tiny electronic parts. For long-term storage, in order to ensure service life and reliability, please observe the following precautions:

◆ Storage sites

Ambient temperature and humidity: Please keep it in a place where the temperature is -30°C - +60°C, below 95%RH, there will be no condensation and ice, and no direct sunlight.

During transportation, please pack the drive and keep it properly to avoid vibration or impact.

Dust and oil mist: Do not store in the environment where there is a lot of dust and oil mist, such as cement factories and textile factories.

Corrosive gas: Do not store it in places where corrosive gas may be generated, such as chemical plants, oil refineries, or sewage treatment plants.

Salt erosion: Do not store it in salt-eroded places such as near the coast, especially in certain salt-eroded areas.

In addition, please do not store it in other harsh environments, but should be stored in warehouses, offices, etc. that are not affected by the above factors.

◆ Regularly power-on

In order to prevent the capacitors from deteriorating, please energize them for at least 30 minutes per year.

If there is no power on for more than two years, please use the adjustable power supply to slowly increase the voltage from 0V to the rated voltage of the drive within 2 minutes to 3 minutes, and then activate the main circuit electrolytic capacitor (no-load power on for more than 1 hour). In the subsequent operation, please perform normal wiring and confirm that there is no abnormality of the drive, overcurrent, motor vibration, speed change, etc. during operation.

8 End-Of-Life Disposal

8.1 Safety Precautions

Danger

To prevent electric shock

Do not perform wiring, inspection or repair work while the power is on. Before starting work, be sure to switch off the power of all machines. After the power is switch off, there is still residual voltage in the capacitor inside the drive. It is necessary to confirm that the main circuit voltage has fallen to a safe level, and wait 5 minutes before performing related operations. If you neglect the operation, it may cause personal accidents.

During the operation of the drive, please do not change the wiring, remove the wiring and option cards, or replace the cooling fan.

When using an drive to drive a motor, even if the power to the drive is switched off, an induced voltage will be generated on the motor terminals during motor rotation, so, wait until the motor cord is disconnected or confirm that the motor is no longer rotating before performing the above operation. There is a risk of electric shock if operated incorrectly.

Warning

To prevent electric shock

Do not operate with the drive cover removed, otherwise there will be a risk of electric shock.

Be sure to operate the drive in accordance with the instruction manual with the specified cover or housing installed.

Be sure to ground the ground terminals on the motor side, otherwise electric shock may result from human contact with the motor housing.

Non-electrical construction professionals are not allowed to perform wiring, installation, inspection, maintenance, component replacement or repair operations, otherwise there is a danger of electric shock.

If you are wearing loose clothing or accessories, do not work on the drive. Please take off metal objects such as watches and rings and wear loose clothes before work, otherwise there will be a risk of electric shock.

To prevent fire

Please tighten the terminal screws according to the tightening torque in this manual. If the tightening torque is insufficient, the connection parts may overheat and cause a fire.

If the tightening torque exceeds the specified tightening torque, it may cause malfunction of the device, damage to the terminal blocks, or cause a fire.

Ensure to use the correct voltage of the main circuit power supply. Before energizing, please confirm whether the rated voltage of the drive is consistent with the power supply voltage. If the main circuit power supply voltage is used incorrectly, there is a danger of fire.

Do not make flammable materials close to the drive or attach flammable materials to the drive. Please install the drive on a flame-retardant object such as metal. Otherwise, there will be a risk of fire.

Caution

The heat sink of the drive will generate high temperature, please do not touch it.

When operating the drive, please follow the steps specified in ESD prevention measures, otherwise the internal circuits of the drive may be damaged due to static electricity.

Please do not change the circuit of the drive, otherwise it will cause damage to the drive, and the repair caused by this is not covered by our warranty, and we will not be responsible for it.

After completing the wiring of the drive and other machines, please make sure that all of the wirings were correct. If the wiring is wrong, the drive may be damaged.

Please confirm the direction of rotation when the motor is under no load. The wrong direction of rotation may cause personal injury or property damage.

Do not operate a damaged machine. If the machine is obviously damaged or parts are missing, please do not connect or operate it to avoid accidents.

8.2 Disposal Related Precautions

Disposal of products and components should be carried out in accordance with local regulations and the relevant laws or regulations of each country or region.



- 1) The main body of the drive.
- 2) Packaging materials.
- 3) extension card.

Note! In order to prevent injury, please dispose it properly after powering off and discharging. Avoid causing safety accidents.

9 External Equipment and Options



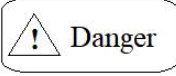



9.1 Safety Precautions









When using external equipment and options, users must comply with the following safety precautions and related requirements.

	<ul style="list-style-type: none"> Do not perform related operations with the power on, otherwise there will be a risk of electric shock. Before performing related operations, please switch off the power of all equipment and confirm that the DC voltage of the main circuit has dropped to a safe level. Wait 5 minutes before performing related operations.
	<ul style="list-style-type: none"> Do not run with the drive cover/panel removed, otherwise there will be a risk of electric shock. Do not remove the cover of the drive or touch the printed circuit board when the power is on, otherwise there will be a risk of electric shock. This product, external equipment and optional parts must be installed, commissioned and maintained by professional personnel, otherwise it may lead to danger. When performing installation, commissioning, maintenance, etc., please do not wear loose clothing and use relevant protective tools and protection measures. During the operation of the drive, please do not change the wiring, remove the jumper, option card, or replace the cooling fan, otherwise there will be a risk of electric shock. Please tighten the terminal screws according to the specified torque. If the connection of the main circuit wire is loose, it may cause a fire due to overheating of the wire connection. This product, external equipment and options must be reliably grounded to prevent damage to the human body due to leakage and induced electric potential.
<p>Important</p>	<ul style="list-style-type: none"> Please observe the measures and methods specified in ESD prevention measures (ESD) before performing related operations, otherwise the drive may be damaged. Do not switch off the power supply while the drive is outputting voltage, otherwise the drive will be damaged.

9.2 External Equipment

Commonly used external devices are shown in the following table. For the order of external equipment, please consult our company's agent or sales department.

External Device Name		Purpose of Usage
	Breaker	In the event of a short-circuit accident, it protects the power supply system, prevents the extension of the fault from affecting the operation of other normal equipment, and plays a role in overload protection.
	Leakage circuit breakers	Grounding protection to prevent electric shock accidents (recommended to use to prevent high-frequency leakage current).
	Electromagnetic contactor	Separate the power supply and the drive, and realize the basic relay control.
	AC input reactor	Improve the power factor of the power supply side and isolate the interference of the noise signal on the power supply side to the drive.
	DC Reactor	Suppress high-order harmonics and improve the power factor of the power supply.
	Input side noise filter	Reduce the drive's interference to the power supply, while effectively reducing the interference from the power grid.

	Braking resistor	Passive energy consumption unit for electric braking.
	Energy consumption braking unit	The electric brake control unit is used to control the brake resistor to effectively consume the regenerative electric energy of the motor.
	Output side noise filter	Reduces electromagnetic interference from the wires on the output side of the drive.
	Backup system	Backup control system when the drive fails.
	Thermal relay	Protects the motor in case of overload.
	Zero-phase reactor	Reduce the electromagnetic induction interference of the drive (applicable to either side of the input side and output side of the drive).
	Main circuit surge absorption unit	Suppress the surge voltage generated during the operation of the main circuit switching device.
	Coil surge absorption unit	Suppress the surge voltage generated during the operation of the AC contactor.

9.3 Use of External Equipment

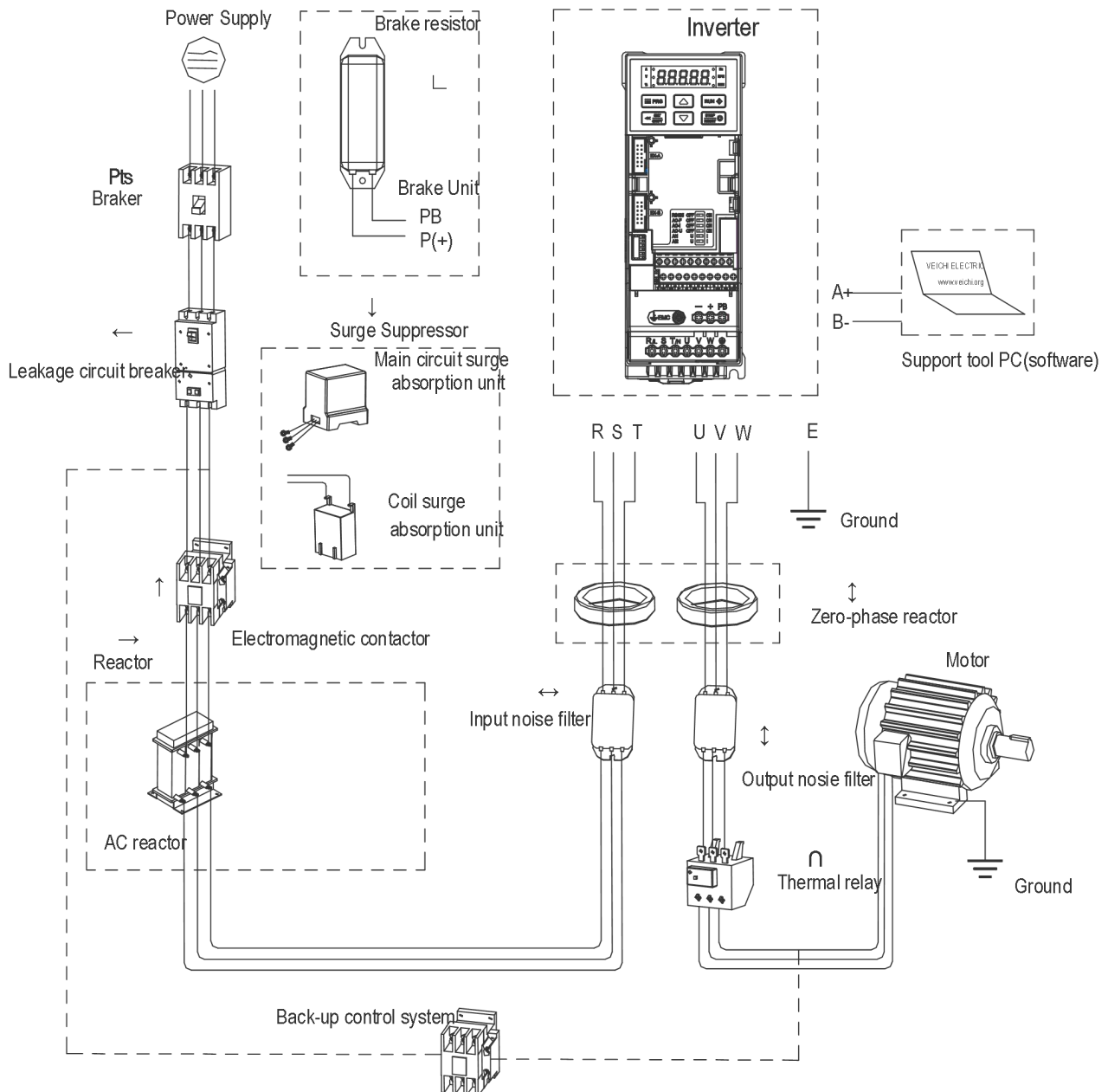

Figure 9-1: Connection block diagram of external devices

Fi

Note:

Circuit breaker for wiring

In order to ensure the safety of the wiring, protect the power supply system in the event of a short-circuit accident, prevent the extension of the fault from affecting the operation of other normal equipment, and play the role of overload protection. Be sure to use a circuit breaker for wiring between the power supply and the main circuit power input terminals R, S, T.



Caution: When selecting the circuit breaker, its capacity should be roughly equal to 1.5 to 2 times the rated output current of the drive. When selecting, please compare the time characteristics of the circuit breaker with the time characteristics of the drive protection (150% of the rated output current, 1 minute) to ensure no false trips.



Warning: Before wiring the main circuit terminals, please switch off the circuit breaker and electromagnetic contactor, otherwise there will be a risk of electric shock.

Leakage circuit breakers

Since the output of the drive is a square wave with high-speed switching of peak voltage, high-frequency leakage current will be generated. In order to implement grounding protection to prevent electric shock accidents and induced leakage fires, install a leakage circuit breaker. Generally, one drive generates a leakage current of about 100 mA (when the power cable length is 1 m), each extension of the power cable by 1 m, the leakage current will increase about 5 mA. Therefore, the circuit breaker used on the input side of the drive power supply should be a leakage circuit breaker specially designed for high-frequency leakage current. The high-frequency leakage current can be removed by a special circuit breaker, and only the frequency band leakage current that is harmful to the human body can be detected. The factors that affect the leakage current are as follows: the capacity of the drive, the carrier frequency, the type of the motor cable and the length of the wiring.

EMI/RFI filter

In order to protect the human body and the drive, please select a leakage circuit breaker that can use both AC and DC power supplies and can handle high-frequency leakage current. On each drive, a leakage circuit breaker with a sensitivity current of more than 200mA should be selected and installed. Depending on the output waveform of the drive, the high-frequency leakage current may increase, which may cause the leakage circuit breaker to malfunction.

In this case, please take the following measures:

1. Increase the induced current of the leakage circuit breaker.
2. Reduce the carrier frequency of the drive.

Electromagnetic contactor

The electromagnetic contactor is an external device installed to effectively separate the power supply from the drive connection. When the drive protection function is Valid or an emergency stop operation is performed, the main circuit power supply can be disconnected through the external controller. Do not connect the electromagnetic switch or electromagnetic contactor to the output circuit of the drive, otherwise the drive may be damaged. After an instantaneous power failure occurs during operation, the power supply is restored. If it is necessary to prevent the drive from automatically re-running, install a control electromagnetic contactor on the input side of the drive.

AC reactor and DC reactor

In order to suppress sharp current changes and high-order harmonic currents, AC input reactors and DC reactors are required. Suppressing high-order harmonic currents will also improve the power factor on the input side of the drive. In the following situations, an AC input reactor or a DC reactor must be used (the effect of using an AC input reactor and a DC reactor at the same time is more significant).

1. When it is necessary to suppress high-order harmonic current or improve the power factor of the power supply side;
2. When the phase-in capacitor needs to be switched;
3. When connecting the drive to a large-capacity power transformer (above 600 kVA);
4. When a thyristor drive such as a DC motor driver is connected to the same power supply system.

If the user has higher suppression requirements for other harmonics, please connect an external DC reactor. Before connecting an external DC reactor, be sure to remove the short link between the P1 and (+) terminals of the drive.

Surge suppressor

Depending on the location of use, surge suppressors can be classified as coil surge suppressors and main circuit surge suppressors. Please select the appropriate surge suppressor for the application. The purpose of installing a surge suppressor is to suppress the surge voltage generated when the switching components of the inductive load (electromagnetic contactor, electromagnetic relay, electromagnetic valve, electromagnetic coil, electromagnetic brake, etc.) connected around the drive work. Do not connect the surge suppressor to the output side of the drive, otherwise the drive will be damaged.

Input side noise filter

Since the rectifier bridge of the drive is an uncontrollable rectification method, the current on the input side is a discontinuous pulse current, so the noise signal generated by the harmonic current flows into the power line from the drive, which may adversely affect surrounding equipment (radios, phones, non-contact switches, sensors). At this time, it is recommended to install a noise filter on the input side to reduce the noise flowing into the power line. In addition, the noise filter can also attenuate the noise entering the drive from the power line.



Caution : Please use the noise filter dedicated to the drive, and try to shorten the connection length between the noise filter and the drive.

Output side noise filter

Since the output of the drive is a square wave with high-speed switching of peak voltage, there is high-speed dv/dt conversion on the output cable of the drive. This high-speed dv/dt conversion will generate a lot of radio interference and induced interference signals. By installing a noise filter on the output side of the drive, the effects of radio interference and inductive interference can be effectively mitigated. Do not connect the phase-in capacitor and the noise filter with capacitor to the output circuit of the drive, otherwise the drive will be damaged.

Zero-phase reactor

The zero-phase reactor is used to reduce the electromagnetic induction interference of the drive. It is suitable for the input side and output side of the drive. It is equivalent to a three-phase common-mode inductor. In actual use, according to the actual magnetic core size and cable specifications, it is best to ensure the winding ratio of 3 to 5 turns in order to maximize the role of the zero-phase reactor.

Braking resistor or braking unit

For details on the consumption units for regenerative energy, see Chapter 3, Section 6, "Electrical Installation".

Thermal relay

Install a thermal relay on the output side of the drive. When the motor enters an overload state, the thermal relay will switch off the power source of the motor to protect the motor. When using one drive to drive one motor, there is no need to install a thermal relay. At this case, the overload protection is performed by the motor overload protection curve coefficient [F10.59] in the drive. If one drive drives multiple motors or when the motor is directly operated by grid power, please install a thermal relay between the drive and the motor. When installing the thermal relay, please design to switch off the sequence control circuit of the electromagnetic contactor (MC) on the main circuit input side through the contact of the thermal relay or input the action of the thermal relay as an external fault into the drive. When installing a thermal relay on the drive, please pay attention to the following items to avoid malfunction of the thermal relay or overheating of the motor during low-speed operation.

1. When running at low speed
2. When one drive drives multiple motors
3. When the motor cable is too long
4. When the fault is detected by mistake due to the high carrier frequency
5. Low speed operation and thermal relay





In general, thermal relays are suitable for general-purpose motors. When running a general-purpose motor (standard motor) with an drive, the motor current will increase by 5% to 10% compared to when running with a commercial power supply. In addition, during low-speed operation, even if the motor is operated within the rated current value range of the motor, the cooling capacity of the fan driven by the motor shaft will decrease, which may cause the motor to overheat. Therefore, please try to set the motor overload protection parameter [F10.55 - F10.59] function in the drive to a reasonable value.





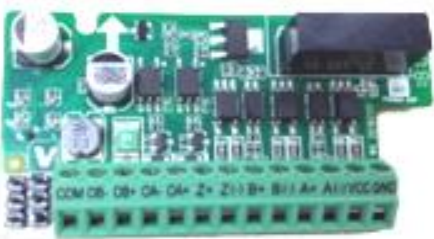

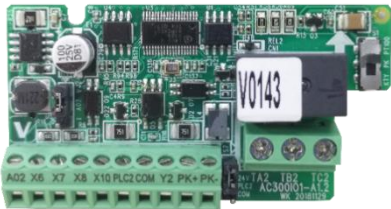
When the motor cable is very long

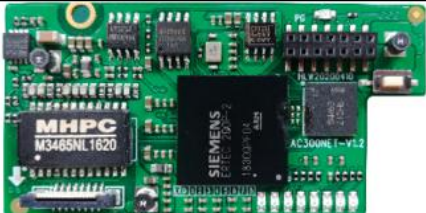
When the wiring of the motor cable is very long and the carrier frequency is high, the thermal relay may be faulty due to the leakage current. To avoid this, reduce the carrier frequency or set a higher detection value for the thermal relay operation. Before increasing the action detection value of the thermal relay, be sure to confirm whether there are other reasons that cause the motor to overload, otherwise it may be dangerous.

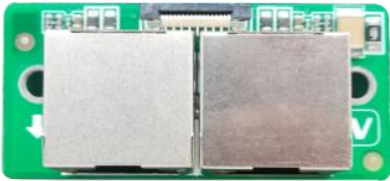
9.4 Installation and Wiring of Option Cards

Option card model:

Image	Model	Description
	<p>AC300-PG01 (5V) Differential PG card</p>	<p>5 V differential signal input, support maximum frequency 500 kHz, with input signal disconnection detection function.</p>
	<p>AC300-PG01 (12V) Differential PG card</p>	<p>12 V differential or OC signal input, support a maximum frequency of 500 kHz, with input signal disconnection detection function.</p>
	<p>AC300RT1 Resolver card</p>	<p>Supports resolvers with four different ratios of 0.219, 0.286, 0.5, 0.58, and the Default ratio is 0.5.</p>
	<p>AC300IO1 Terminal extension card</p>	<p>Four digital inputs (X10 supports 50K pulse input), one digital output, one analog output, and one relay output. Support temperature detection (PT100, PT1000 and KTY84).</p>
	<p>AC300CAN1</p>	<p>CANopen communication extension card.</p>
	<p>AC300DP01</p>	<p>Profibus communication extension card.</p>
	<p>AC300PN card</p>	<p>PROFINET communication extension card.</p>

		
	<p>KBD10-15 Single-line digital tube keypad</p>	<p>External LED five-digit display and operation Keypad, support potentiometer speed control.</p>
	<p>KBD300-25 Dual-line digital tube keypad</p>	<p>Dual-line external five-digit display Keypad, Silicone keypad, and digital potentiometers.</p>
	<p>KBD300-L1 LCD keypad</p>	<p>User-friendly human-machine interface.</p>
	<p>AC300-SL-A1.1 Flash card</p>	<p>For AC310, parts of the general drive burn-in program can be opened to the core agents (authorized by the regional director.)</p>
	<p>IOT-GWS2.0</p>	<p>Equipment positioning and maintenance, real-time monitoring, and data collection.</p>

Note: Do not plug or unplug the option card under power.

9.4.1 AC300CAN1 communication card

AC300CAN1 communication card is specially configured for our AC310 series machines. The CAN bus port is fully compliant with ISO/DIS11898 standard to realize CAN communication between multiple drives. The drive can be connected to the high-speed CAN communication network for field bus control. Before using the AC300CAN1 communication card, please read the AC300CAN1 communication card manual carefully.

The connection port of the AC300CAN1 communication card adopts terminal wiring; the AC300CAN1 communication card can be installed on the EX-A extension port and EX-B extension port of the drive.

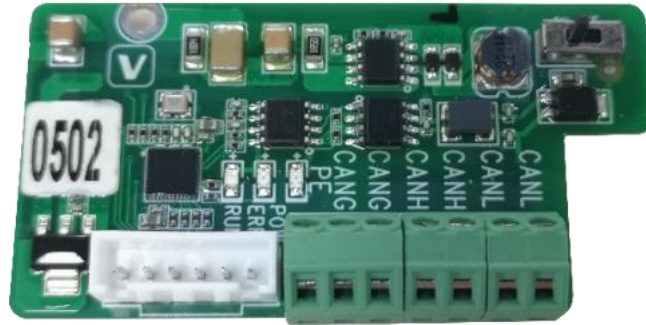

Front view of AC300CAN1

Terminal wiring

The 6-pin European terminal is used as the port to connect to the CAN bus with number CN4, located on the front of the communication card, which greatly facilitates the parallel connection of customers (CANH, CANL can realize one input and one output). The pin diagram and function table are as follows:

Table 1.1: Description of wiring port definition

CN4 port function table		
Pin number	Name	Function
1	PE	Ground terminal of the cable shielding layer.
2	CANH	Connect the positive terminal of the CAN bus.
3	CANH	Connect the positive terminal of the CAN bus.
4	CANL	Connect the negative terminal of the CAN bus.
5	CANL	Connect the negative terminal of the CAN bus.
6	CANG	Connect the CAN bus signal reference ground.

9.4.2 AC300IO1 extension card

AC300IO1 extension card is a terminal extension card suitable for our AC310 series drives. Enrich the drive's digital input, output, analog input and output functions to meet various application requirements under specific occasions. Before using the AC300IO1 extension card, please read the AC300IO1 extension card instruction manual carefully.

The AC300IO1 extension card wiring port adopts terminal wiring, and the AC300IO1 extension can be installed in the EX-A extension port and EX-B extension port of the drive.



1.1. Technical Specification

Category	Digital input signal characteristics.			
	Signal name	Response frequency range	Input resistance	Effective level range
Input signal	X6, X7, X8	0 kHz~5kHz	4.4k Ω	High level: 10 V - 30 V Low level: 0 V - 5 V
	X10	0 kHz~50kHz	1.5 k Ω	High level: 10 V - 30 V Low level: 0 V - 5 V
Select PLC2 to connect to 24 V or COM through jumper switch S7, support NPN, PNP transistor signal input.				
Category	Digital output signal characteristics.			
	Signal name	Output mode	Maximum Output	
Output signal	Y2	NPN composite triode Open collector output.	DC24V/50mA	
	TA2, TB2, TC2	The relay is normally open and normally closed output.	3A/250VAC 3A/30VDC	
Category	AO2 analog output signal characteristics (selected by J2 jumper switch).			
	Signal name	Output capacity	Remarks	
AO2	AO2-V (voltage output)	DC0 V - 10 V output.	The maximum output is 2 mA.	
	AO2-I (current output)	DC0 mA - 20 mA or 4 mA - 20 mA output.		
PK+/PK- temperature sensor signal				
Signal name	Thermocouple category	Selection mode	Input mode	Detection temperature range
PK+/PK-	PT100	Dip switch S1 selection.	Differential two-wire input.	0°C~220°C
	KTY84	DIP switch S1 cooperates with parameter F10.26 to set and select.		
	PT1000			

9.4.3 AC300DP01 card

AC300DP01 is specially configured for our company's AC310 series machines to realize field bus control; AC300DP01 card uses a standard DB9 socket to connect to the Profibus master station. Before using the AC300DP01 card, please read the AC300Profibus-DP card manual carefully.

The pin signal definition is shown in the figure below:

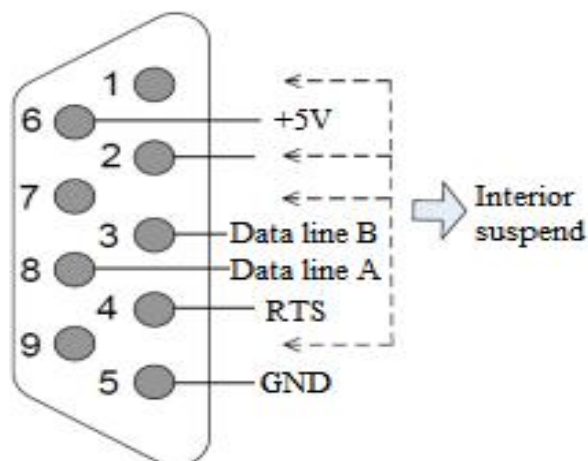

The description of Profibus DB9 terminal is as follows:

Terminal Symbol	Terminal Name	Function Description
1,2,7,9	NC	The interior is suspended.
3	Data line B	The positive pole of the data line.
4	RTS	Request to send a signal.
5	GND	Isolate the 5 V power supply to ground.
6	+5V	Isolate the 5 V power supply.
8	Data line A	The negative pole of the data line.

9.4.4 AC300PG01 extension card

AC300-PG01 extension card is a PG feedback extension card that can be used for our AC310 series drives. Supports differential input with a maximum frequency of 500 kHz. It supports two output modes: differential and transistor open collector. The AC300-PG01 extension card can only be installed in the **EX-B extension port of the drive**. Before using the AC300-PG01 extension card, please read the AC300-PG01 extension card instruction manual carefully.

AC300-PG01 extension card terminals are arranged as follows:

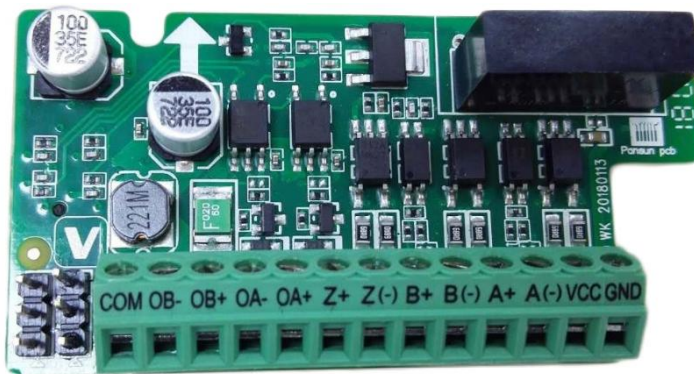

Functional Description of Signal Terminals

Terminal Definition	Terminal Name	Description
Encoder Signal and Power Supply Terminals	A+, A-	Encoder phase A feedback input signal.
	B+, B-	Encoder phase B feedback input signal.
	Z+, Z-	Encoder phase Z feedback input signal.
	VCC	Encoder power supply +, + 5 V.
	GND	Encoder power supply -, 0 V.
PG Card Signal Output Terminals	OA+, OA-	PG card phase A signal output (differential, OC).
	OB+, OB-	PG card phase B signal output (differential, OC).
	COM	Zero-potential point when OC signals are output.

9.4.5 AC300RT1 resolver PG feedback card

The AC300RT1 resolver PG feedback card specially designed for resolvers applies to the AC310 series drives. The AC300RT1 resolver PG feedback card can only be installed onto the EX-B extension port of the drive. Before using the AC300RT1 resolver PG feedback card, please read the instructions of AC300RT1 resolver PG feedback card carefully.

The terminals of AC300RT1 resolver PG feedback card are arranged as follows. To use the S4 DIP switch, dial the right side (for AC310).

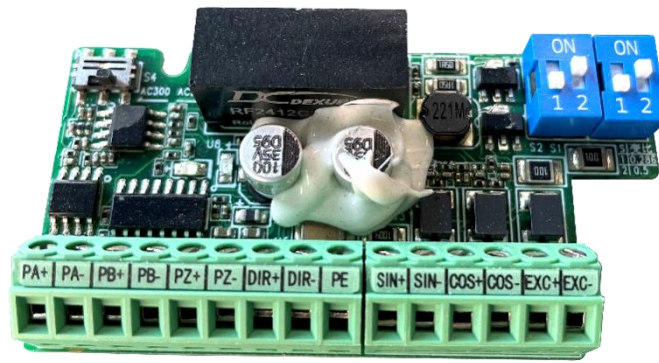

Front View of AC300RT1

Terminal Wiring Description

There are two European terminals (9-pin and 6-pin) on the resolver, with position numbers of M5 and M3 respectively and spacing of 3.5 mm. The terminal signals are defined as follows:

6-Pin European Terminal Signal Definition Description			9-Pin European Terminal Signal Definition Description		
Pin Number	Pin Name	Functional Description	Pin Number	Pin Name	Functional Description
1	SIN+	Sinusoidal feedback signal positive.	1	PA+	Frequency division output A signal positive.
2	SIN-	Sinusoidal feedback signal negative.	2	PA-	Frequency division output A signal negative.
3	COS+	Cosine feedback signal positive.	3	PB+	Frequency division output B signal positive.
4	COS-	Cosine feedback signal negative.	4	PB-	Frequency division output B signal negative.
5	EXC+	Excitation output signal positive.	5	PZ+	Frequency division output Z signal positive.
6	EXC-	Excitation output signal negative.	6	PZ-	Frequency division output Z signal negative.
			7	DIR+	Frequency division output direction signal positive.
			8	DIR-	Frequency division output direction signal negative.
			9	PE	Ground terminal of the cable shielding layer.

10 Parameter List

10.1 Safety Precautions

Danger
Please follow all the safety instructions in this manual.
Failure to follow the precautions may result in death or serious injury. Please be cautious. We will not take any responsibility for personal injuries and equipment damages caused by your company or your customers due to not complying with the contents of this Manual.

10.2 Parameter List Reading Instructions

◆ indicates an icon or term of a control mode

Icon	Description
V/F	Active parameters under V/F control mode of an asynchronous motor.
SVC	Active parameters under SVC mode of an asynchronous motor.
FVC	Active parameters under FVC mode of an asynchronous motor.
PMVF	Active parameters under V/F control mode of a synchronous motor.
PMSVC	Active parameters under SVC mode of a synchronous motor.
PMFVC	Active parameters under FVC mode of a synchronous motor.

Note: A control mode icon without shade indicates that the parameter is Invalid under the control mode.

10.3 Parameter Groups

10.3.1 Parameter Types of the Drive

Parameter	Name	
Group F00: Environmental Application	F00.0x	Environment settings.
	F00.1x	Common parameter settings.
Group F01: Basic Settings	F01.0x	Basic commands.
	F01.1x	Frequency commands.
	F01.2x-F01.3x	Acceleration/deceleration time.
	F01.4x	PWM control.
Group F02: Motor 1 Parameters	F02.0x	Basic motor parameters and Auto-tuning selection.
	F02.1x	Advanced parameters of asynchronous motor.
	F02.2x	Advanced parameters of synchronous motor.
	F02.3x-F02.4x	Encoder parameters.
	F02.5x	Motor application parameters.
Group F03: Vector Control	F03.0x	Speed loop.
	F03.1x	Current loop and torque limits.
	F03.2x	Torque optimization control.
	F03.3x	Flux optimization.
	F03.4x-F03.5x	Torque control.
	F03.6x	PM high-frequency injection.
	F03.7x	Position compensation.
	F03.8x	extension control.

Group F04: Voltage/Frequency (V/F) Control	F04.0x	V/F control.
	F04.1x	Custom V/F curve.
	F04.2x	V/F separation control.
	F04.3x	V/F energy-saving control.
Group F05: Input Terminals	F05.0x	Digital input terminal function.
	F05.1x	Digital input terminal detection delay.
	F05.2x	Digital input terminal action selection.
	F05.3x	PUL terminal.
	F05.4x	Analog type processing.
	F05.5x	Analog linear processing.
	F05.6x	Analog input (AI) curve 1 processing.
	F05.7x	AI curve 2 processing.
Group F06: Output Terminals	F05.8x	AI as digital input terminals.
	F06.0x	Analog output (AO).
	F06.1x	Expanded AO.
	F06.2x- F06.3x	Digital and relay output.
	F06.4x	Frequency detection.
	F06.5x	Monitoring parameter comparator output.
Group F07: Running Control	F06.6x- F06.7x	Virtual input and output terminals.
	F07.0x	Start control.
	F07.1x	stop control.
	F07.2x	DC brake and speed tracking.
	F07.3x	Jog.
Group F08: Auxiliary Control 1	F07.4x	Start and stop frequency maintenance and frequency hopping.
	F08.0x	Counting and timing.
	F08.1x	Reserved
	F08.2x	Reserved
	F08.3x	Swing frequency control.
Group F09: Auxiliary Control 2	F08.4x	Reserved
	F09.0x	Maintenance function.
Group F10: Protection Parameters	F10.0x	Current protection.
	F10.1x	Voltage protection.
	F10.2x	Auxiliary protection.
	F10.3x	Load protection.
	F10.4x	Stall protection.
	F10.5x	Fault recovery and motor overload protection.
Group F11: Keypad Parameters	F11.0x	Key operation.
	F11.1x	Status interface loop monitoring.
	F11.2x	Monitoring parameter control.
	F11.3x	Special Keypad functions.
Group F12: Communication Parameters	F12.0x	Modbus slave parameters.
	F12.1x	Modbus master parameters.
	F12.2x	Modbus special functions.
	F12.3x	PROFIBUS-DP communication group.
	F12.4x	CAN communication group.
	F12.5x	Communication of extension ports EX-A and EX-B.

Group F13: Process PID Control	F13.00-F13.06	PID setting and feedback.
	F13.07-F13.24	PID regulation.
	F13.25-F13.28	PID feedback disconnection judgment.
	F13.29-F13.33	Sleep function.
Group F14: Multi-Speed and Simple PLC	F14.00-F14.14	Multi-speed frequency setting.
	F14.15	PLC running mode selection.
	F14.16-F14.30	PLC running time selection.
	F14.31-F14.45	PLC direction and acceleration/deceleration time selection.
Group F15	--	--
Group F16: Tension Control	F16.00-F16.82	Tension control parameter group.
Group F17	--	--
Group F18	--	--
Group F19	F19.00-F19.63	User programmable function group A.
Group F20	F20.00-F20.63	User programmable function group B.
Group F21	F21.00-F21.xx	Industry application extension.
Group F22	--	--
Group F23	--	--
Group F24	--	--
Group F25	F25.00-F25.xx	AI and AO calibration.
Monitoring parameter group	C00.xx	Basic monitoring.
	C01.xx	Fault monitoring.
	C02.xx	Applications.
	C03.xx	Maintenance and tension control monitoring.
	C04.xx	Industry application monitoring.
	C05.xx	Control and monitoring.
	C06.xx-C07.xx	Option card monitoring parameter group.
Communication variable group	Modbus basic communication group	Communication addresses 0x3000-0x301F, 0x2000-0x201F.
	Option card basic communication group	Communication addresses 0x3100-0x311F.
	Input/output interface group	Communication addresses 0x3400-0x341F.
	Cache register group	Communication addresses 0x3500-0x350F.
	extension fault and power-off parameter group	Communication addresses 0x3600-0x361F.

10.3.2 Parameter attributes of the drive

The adjustable attributes of parameters are described in the table below.

Adjustable Attribute of Parameter	Description
STOP	The parameter cannot be changed during running.
RUN	The parameter can be changed during running.
READ	The parameter is read only and cannot be changed.

10.4 Group F00: Environmental Application

Group F00.0x: Environment Settings

Parameter Code (Address)	Name	Description	Default (Range)	Reference Source
--------------------------	------	-------------	-----------------	------------------

F00.00 (0x0000) RUN	Parameter access level	V/F SVC FVC PMVF PMSVC PMFVC Set the parameter access level according to the parameter access limitations. 0: Standard parameter (Fxx.yy, Cxx.yy) 1: Common parameter (F00.00, Pxx.yy) 2: Monitoring parameter (F00.00, Cxx.yy) 3: Parameter changed (F00.00, Hxx.yy)	0 (0~3)	F00.0x
F00.01 (0x0001) STOP	Use selection	V/F SVC FVC PMVF PMSVC PMFVC Set the drive for the intended use. 0: General 1: Fan/water pump	0 (0~1)	
F00.02 (0x0002)	Reserved			
F00.03 (0x0003) STOP	Initialization	V/F SVC FVC PMVF PMSVC PMFVC Set the initialization mode of the drive. 0: No initialization. 11: Initialize parameters (excluding motor parameters) according to the set point of use selection. 22: Initialize all parameters. 33: Clear fault records	0 (0~33)	
F00.04 (0x0004) STOP	Keypad parameter copy	V/F SVC 0: No function. 11: Upload parameters to the Keypad 22: Download parameters to the drive	0 (0~30)	
F00.05 (0x0005) STOP	Reserved			
F00.06 (0x0006) RUN	Reserved			
F00.07 (0x0007) RUN	Free parameter 1	V/F SVC FVC PMVF PMSVC PMFVC Serves as the unit number when multiple units are used. Serves as the mode number for each use when multiple units are used.	0 (0~65535)	
F00.08 (0x0008) RUN	Free parameter 2	V/F SVC FVC PMVF PMSVC PMFVC Serves as the unit number when multiple units are used. Serves as the mode number for each use when multiple units are used.	0 (0~65535)	

Group F00.1x: Common Parameter Settings

Parameter Code (Address)	Name	Description	Default (Range)	Reference Source
F00.10~F00.39 (0x000A~0x0027) RUN	Common parameter address setting	V/F SVC FVC PMVF PMSVC PMFVC LED"0" and LED"00"s: Sets yy (00-99) in function parameter number Fxx.yy. LED"000" and LED"0000"s: Sets xx (00-31) in function parameter number Fxx.yy.	Determined by F00.01 (0000~2999)	F00.1x

10.5 Group F01: Basic Settings

Group F01.0x: Basic Commands

Parameter Code (Address)	Name	Description	Default (Range)	Reference Source
F01.00 (0x0100) STOP	Motor control mode	V/F SVC FVC PMVF PMSVC PMFVC Set the control mode of motor. AM: 0: AM-VF; VF control 1: AM-SVC; open-loop vector control, current closed-loop control 2: AM-FVC; closed-loop vector control PM: 10: PM-VF; VF control 11: PM-SVC; Open-loop vector control 12: PM-FVC; Closed-loop vector control POWER: 20: VF-separation: Voltage-frequency separation control (available only for T3 models of 7.5 kW or above T2 models of 5.5 kW and above).	0 (0~20)	F01.0x
F01.01 (0x0101) RUN	Run command channel	V/F SVC FVC PMVF PMSVC PMFVC Select the channel for the drive to accept the run and stop commands and the running direction. 0: Keypad control (the external keypad takes precedence) 1: Terminal control 2: RS485 communication control 3: Option card 4: Terminal switching command given	0 (0~3)	
F01.02 (0x0102) RUN	Frequency given source channel A	V/F SVC FVC PMVF PMSVC PMFVC Set the frequency given source of the drive. 0: Keypad digital given 1: Keypad potentiometer (optional external single-line keypad) 2: Current/voltage analog AI1 3: Current/voltage analog AI2 4: Reserved 5: Terminal pulse PUL 6: RS485 communication 7: Terminal UP/DW control 8: PID control 9: Program control (PLC) 10: Option card 11: Multi-speed	0 (0~11)	
F01.03 (0x0103) STOP	Gain of frequency given source channel A	V/F SVC FVC PMVF PMSVC PMFVC Set the gain of frequency given source channel A.	100.0% (0.0%~500.0%)	
F01.04 (0x0104) RUN	Frequency given source channel B	V/F SVC FVC PMVF PMSVC PMFVC Set the frequency given source of the drive. Same as [F01.02]	2 (0~11)	
F01.05 (0x0105) STOP	Gain of frequency given source channel B	V/F SVC FVC PMVF PMSVC PMFVC Set the gain of frequency given source channel B.	100.0% (0.0%~500.0%)	

F01.06 (0x0106) RUN	Frequency channel B reference source	V/F SVC FVC PMVF PMSVC PMFVC Select the reference source for frequency given channel B. 0: Use the maximum output frequency as the reference source. 1: Use the set frequency of channel A as the reference source	0 (0~1)	
F01.07 (0x0107) RUN	Frequency given source selection	V/F SVC FVC PMVF PMSVC PMFVC Select the combination mode of frequency given source channel A and channel B of the drive. 0: Channel A 1: Channel B 2: Channel A + Channel B 3: Channel A - Channel B 4: Channel A or Channel B, whichever is the larger 5: Channel A or Channel B, whichever is the smaller	0 (0~5)	
F01.08 (0x0108) RUN	Frequency given with run command binding	V/F SVC FVC PMVF PMSVC PMFVC When activated, this parameter is used to set the frequency source channel bound by each run command channel. LED "0": Keypad command binding LED "00": Terminal command binding LED "000": Communication command binding LED "0000": Option card command binding 0: No binding 1: Keypad digital given 2: Keypad potentiometer (optional external single-line keypad) 3: Current/voltage analog AI1 4: Current/voltage analog AI2 5: Reserved 6: Terminal pulse PUL 7: Communication 8: Terminal UP/DW control 9: PID control A: Program control (PLC) B: Option card C: Multi-speed D: Reserved	0000 (0000~DDDD)	
F01.09 (0x0109) RUN	Keypad digital given frequency	V/F SVC FVC PMVF PMSVC PMFVC Set and change the frequency set by the keypad digital.	50.00 Hz (0.00 - upper limit frequency)	

Group F01.1x: Frequency Command

Parameter Code (Address)	Name	Description	Default (Range)	Reference Source
F01.10 (0x010A) STOP	Maximum frequency	V/F SVC FVC PMVF PMSVC PMFVC Set the maximum frequency for the drive.	50.00 Hz (Upper limit frequency ~500.00 Hz)	F01.1x
F01.11 (0x010B) RUN	Upper frequency limit source selection	V/F SVC FVC PMVF PMSVC PMFVC Select the reference source for the upper frequency limit of the drive. 0: Upper limit frequency digital setting	0 (0~7)	

		1: Keypad potentiometer (optional external single-line keypad) 2: Current/voltage analog AI1 3: Current/voltage analog AI2 4: Reserved 5: Terminal pulse PUL 6: RS485 communication 7: Option card		
F01.12 (0x010C) RUN	Upper frequency limit digital setting	V/F SVC FVC PMVF PMSVC PMFVC Set the upper frequency limit reference channel when F01.11 is set as 0.	0.00 Hz (lower frequency limit - maximum frequency)	
F01.13 (0x010D) RUN	Lower frequency limit	V/F SVC FVC PMVF PMSVC PMFVC Set the lower frequency limit to limit the frequency setting.	0.00 Hz (0.00 - upper frequency limit)	
F01.14 (0x010E) STOP	Frequency command resolution	V/F SVC FVC PMVF PMSVC PMFVC Set the resolution of frequency commands. 0: 0.01Hz 1: 0.1Hz 2: 0.1rpm 3: 1rpm	0 (0~3)	

Group F01.2x~F01.3x: Acceleration/Deceleration Time

Parameter Code (Address)	Name	Description	Default (Range)	Reference Source
F01.20 (0x0114) STOP	Reference frequency for acceleration/deceleration time	V/F SVC FVC PMVF PMSVC PMFVC Set the reference frequency for calculating the acceleration/deceleration time. 0: Maximum frequency 1: Fixed frequency 50 Hz 2: Given frequency	0 (0~2)	F01.2x
F01.21 (0x0115) STOP	Unit of acceleration/deceleration time	V/F SVC FVC PMVF PMSVC PMFVC Set the decimal places of acceleration/deceleration time parameters F01.22 - F01.29. 0: 1s 1: 0.1s 2: 0.01s	2 (0~2)	
F01.22 (0x0116) RUN	Acceleration time 1	V/F SVC FVC PMVF PMSVC PMFVC The time required for the output frequency to accelerate from 0.00 Hz to the time reference frequency. 0.01s~650.00s (F01.21 = 2) 0.1s~6500.0s (F01.21 = 1) 1s~65000s (F01.21 = 0)	Model setting (0.01s~650.00 s)	
F01.23 (0x0117) RUN	Deceleration time 1	V/F SVC FVC PMVF PMSVC PMFVC Set the time required for the output frequency to decelerate from the time reference frequency to 0.00 Hz. 0.01s~650.00s (F01.21 = 2) 0.1s~6500.0s (F01.21 = 1) 1s~65000s (F01.21 = 0)	Model setting (0.01s~650.00 s)	
F01.24 (0x0118) RUN	Acceleration time 2	V/F SVC FVC PMVF PMSVC PMFVC The time required for the output frequency to accelerate from 0.00 Hz to the time reference	Model setting (0.01 s~ 650.00 s)	

		frequency.		
F01.25 (0x0119) RUN	Deceleration time 2	V/F SVC FVC PMVF PMSVC PMFVC Set the time required for the output frequency to decelerate from the time reference frequency to 0.00 Hz.	Model setting (0.01 s~ 650.00 s)	
F01.26 (0x011A) RUN	Acceleration time 3	V/F SVC FVC PMVF PMSVC PMFVC The time required for the output frequency to accelerate from 0.00 Hz to the time reference frequency.	Model setting (0.01 s~ 650.00 s)	
F01.27 (0x011B) RUN	Deceleration time 3	V/F SVC FVC PMVF PMSVC PMFVC Set the time required for the output frequency to decelerate from the time reference frequency to 0.00 Hz.	Model setting (0.01 s~ 650.00 s)	
F01.28 (0x011C) RUN	Acceleration time 4	V/F SVC FVC PMVF PMSVC PMFVC The time required for the output frequency to accelerate from 0.00 Hz to the time reference frequency.	Model setting (0.01 s~ 650.00 s)	
F01.29 (0x011D) RUN	Deceleration time 4	V/F SVC FVC PMVF PMSVC PMFVC Set the time required for the output frequency to decelerate from the time reference frequency to 0.00 Hz.	Model setting (0.01 s~ 650.00 s)	
F01.30 (0x011E) STOP	S-curve acceleration/dec eleration selection	V/F SVC FVC PMVF PMSVC PMFVC Set whether the S-curve acceleration/deceleration selection is Valid. 0: Invalid 1: Valid 2: Flexible S-curve	1 (0~2)	
F01.31 (0x011F) STOP	S-curve acceleration start time	V/F SVC FVC PMVF PMSVC PMFVC Set the S-curve acceleration start time.	0.20s (0.00s~ 10.00s)	
F01.32 (0x0120) STOP	S-curve acceleration end time	V/F SVC FVC PMVF PMSVC PMFVC Set the S-curve acceleration end time.	0.20s (0.00s~ 10.00s)	
F01.33 (0x0121) STOP	S-curve deceleration start time	V/F SVC FVC PMVF PMSVC PMFVC Set the S-curve deceleration start time.	0.20s (0.00s~ 10.00s)	
F01.34 (0x0122) STOP	S-curve deceleration end time	V/F SVC FVC PMVF PMSVC PMFVC Set the S-curve deceleration end time.	0.20s (0.00s~ 10.00s)	
F01.35 (0x0123) RUN	Frequency of switching between acceleration time 1 and acceleration time 2	V/F SVC FVC PMVF PMSVC PMFVC Set the frequency switch between acceleration time 1 and acceleration time 2.	0.00 Hz (0.00~maximum frequency)	

Group F01.4x: PWM Control

Parameter Code (Address)	Name	Description	Default (Range)	Reference Source
F01.40 (0x0128) RUN	Carrier frequency	V/F SVC FVC PMVF PMSVC PMFVC Set the switching frequency of the drive IGBT.	Model setting (1.0 kHz~16.0 kHz)	F01.4x
F01.41 (0x0129)	PWM control mode	V/F SVC FVC PMVF PMSVC PMFVC LED "0": Relation of carrier with temperature	1111 (0000~1211)	

RUN		<p>0: No relation with temperature 1: Related with temperature LED "00": Relation of carrier with output frequency 0: No relation with output frequency 1: Related with output Frequency LED "000": Random PWM enabling 0: Disabled 1: Activated under V/F mode 2: Activated under vector mode LED "0000": PWM modulation mode 0: Three-phase modulation only 1: Automatic switching between two-phase and three-phase modulation</p>		
F01.43 (0x012B) RUN	Dead-time compensation gain	<p>V/F SVC FVC PMVF PMSVC PMFVC The gain for dead-time compensation</p>	306 (0~512)	
F01.46 (0x012E) RUN	PWM random depth	<p>V/F SVC FVC PMVF PMSVC PMFVC The higher the setting, the greater the carrier fluctuation when random PWM is enabled.</p>	0 (0~20)	

10.6 Group F02: Motor 1 Parameters

Group F02.0x: Basic Motor Parameters and Auto-tuning Selection

Parameter Code (Address)	Name	Description	Default (Range)	Reference Source
F02.00 (0x0200) READ	Motor type	<p>V/F SVC FVC PMVF PMSVC PMFVC Set the type of motor. 0: Asynchronous motor (AM) 1: Permanent magnetic synchronous motor (PM)</p>	0 (0~1)	F02.0x
F02.01 (0x0201) STOP	Number of motor poles	<p>V/F SVC FVC PMVF PMSVC PMFVC Set the number of motor poles.</p>	4 (2~48)	
F02.02 (0x0202) STOP	Rated motor power	<p>V/F SVC FVC PMVF PMSVC PMFVC Set the motor rated power.</p>	Model setting (0.1 kW~ 1,000.0 kW)	
F02.03 (0x0203) STOP	Rated motor frequency	<p>V/F SVC FVC PMVF PMSVC PMFVC Set the motor rated frequency.</p>	Model setting (0.01~ maximum frequency)	
F02.04 (0x0204) STOP	Rated motor speed	<p>V/F SVC FVC PMVF PMSVC PMFVC Set the motor rated speed.</p>	Model setting (0 rpm~ 65,000 rpm)	
F02.05 (0x0205) STOP	Rated motor voltage	<p>V/F SVC FVC PMVF PMSVC PMFVC Set the motor rated voltage.</p>	Model setting (0 V~1,500 V)	
F02.06 (0x0206) STOP	Rated motor current	<p>V/F SVC FVC PMVF PMSVC PMFVC Set the motor rated current.</p>	Model setting (0.1 A~ 3,000.0 A)	
F02.07 (0x0207) STOP	Selection of motor parameter auto-tuning	<p>V/F SVC FVC PMVF PMSVC PMFVC After the parameter auto-tuning is finished, the setting of [F02.07] will be automatically set as "0". 0: No operation 1: Rotary auto-tuning 2: Static auto-tuning</p>	0 (0~20)	

		3: Stator resistance auto-tuning 4-20: Reserved		
--	--	--	--	--

Note: When F02.00 [Motor Type] is set as "synchronous motor", F02.04 [Rated Motor Speed] is calculated by F02.01 [Number of Motor Poles] and F02.03 [Motor Rated Frequency]. Please set the parameters correctly. Formula: $F02.04 [Rated\ motor\ speed] = 60 * F02.03 [Rated\ motor\ frequency] / (F02.01 [Number\ of\ motor\ poles] / 2)$.

Group F02.1x: Advanced Parameters of Asynchronous Motor

Parameter Code (Address)	Name	Description	Default (Range)	Reference Source
F02.10 (0x020A) STOP	No-load current of asynchronous motor	V/F SVC FVC PMVF PMSVC PMFVC Set the no-load current of asynchronous motor.	Model setting (0.1 A~3,000.0 A)	F02.1x
F02.11 (0x020B) STOP	Stator resistance of asynchronous motor	V/F SVC FVC PMVF PMSVC PMFVC Set the stator resistance of asynchronous motor.	Model setting (0.01 mΩ~60,000 mΩ)	
F02.12 (0x020C) STOP	Rotor resistance of asynchronous motor	V/F SVC FVC PMVF PMSVC PMFVC Set the rotor resistance of asynchronous motor.	Model setting (0.01 mΩ~60,000 mΩ)	
F02.13 (0x020D) STOP	Stator leakage inductance of asynchronous motor	V/F SVC FVC PMVF PMSVC PMFVC Set the stator leakage inductance of asynchronous motor.	Model setting (0.001 mH~6,553.5 mH)	
F02.14 (0x020E) STOP	Stator inductance of asynchronous motor	V/F SVC FVC PMVF PMSVC PMFVC Set the stator inductance of asynchronous motor.	Model setting (0.01 mH~65,535 mH)	
F02.15 (0x020F) READ	Stator resistance per-unit value	V/F SVC FVC PMVF PMSVC PMFVC Set the resistance per-unit value of stator.	Model setting (0.01%~50.00%)	
F02.16 (0x0210) READ	Rotor resistance per-unit value	V/F SVC FVC PMVF PMSVC PMFVC Set the resistance per-unit value of rotor.	Model setting (0.01%~50.00%)	
F02.17 (0x0211) READ	Stator leakage inductance per-unit value	V/F SVC FVC PMVF PMSVC PMFVC Set the leakage inductance per-unit value of stator.	Model setting (0.01%~50.00%)	
F02.18 (0x0212) READ	Stator inductance per-unit value	V/F SVC FVC PMVF PMSVC PMFVC Set the inductance per-unit value of stator.	Model setting (0.1%~999.0%)	
F02.19 (0x0213) READ	Decimal place selection for F02.11 - F02.14	V/F SVC FVC PMVF PMSVC PMFVC Set the decimal places of four parameters F02.11 - F02.14.	0000 (0000-2222)	

Group F02.2x: Advanced Parameters of Synchronous Motor

Parameter Code (Address)	Name	Description	Default (Range)	Reference Source
F02.20 (0x0214) STOP	Stator resistance of synchronous motor	V/F SVC FVC PMVF PMSVC PMFVC Set the stator resistance of synchronous motor.	Model setting (0.01mΩ~6000mΩ)	F02.2x
F02.21 (0x0215)	d-axis inductance of	V/F SVC FVC PMVF PMSVC PMFVC Set the d-axis inductance of synchronous motor.	Model setting (0.001mH~	

STOP	synchronous motor		6553.5mH)	
F02.22 (0x0216) STOP	q-axis inductance of synchronous motor	V/F SVC FVC PMVF PMSVC PMFVC Set the q-axis inductance of synchronous motor.	Model setting (0.001mH~6553.5mH)	
F02.23 (0x0217) STOP	Back-EMF of synchronous motor	V/F SVC FVC PMVF PMSVC PMFVC Set the back-EMF of synchronous motor. Only recognized during rotating auto-tuning.	Model setting (0V~1500V)	
F02.24 (0x0218) RUN	Mounting angle of synchronous motor encoder	V/F SVC FVC PMVF PMSVC PMFVC Set the mounting angle of synchronous motor encoder.	Model setting (0.0°~360.0°)	
F02.25 (0x0219) READ	Stator resistance per-unit value of synchronous motor	V/F SVC FVC PMVF PMSVC PMFVC Set the stator resistance per-unit value of synchronous motor.	Model setting (monitor value)	
F02.26 (0x021A) READ	d-axis inductance per-unit value of synchronous motor	V/F SVC FVC PMVF PMSVC PMFVC Set the d-axis inductance per-unit value of synchronous motor.	Model setting (monitor value)	
F02.27 (0x021B) READ	q-axis inductance per-unit value of synchronous motor	V/F SVC FVC PMVF PMSVC PMFVC Set the q-axis inductance per-unit value of synchronous motor.	Model setting (monitor value)	
F02.28 (0x021C) STOP	Pulse width coefficient of synchronous motor	V/F SVC FVC PMVF PMSVC PMFVC Set the pulse width coefficient of synchronous motor.	Model setting (00.00~99.99)	
F02.29 (0x021D) READ	Decimal place selection for F02.20 - F02.22	V/F SVC FVC PMVF PMSVC PMFVC Set the decimal places of three parameters F02.20 - F02.22. This parameter is read only.	0000 (0000~2222)	

Group F02.3x~F02.4x: Encoder Parameters

Parameter Code (Address)	Name	Description	Default (Range)	Reference Source
F02.30 (0x021E) STOP	Types of speed feedback encoder	V/F SVC FVC PMVF PMSVC PMFVC 0: Ordinary ABZ encoder (connected to extension port EX_B) 1: Resolver (connected to extension port EX_B)	0 (0~1)	F02.3x
F02.31 (0x021F) STOP	Encoder direction	V/F SVC FVC PMVF PMSVC PMFVC 0: In the same direction 1: In the opposite direction	0 (0~1)	
F02.32 (0x0220) STOP	ABZ encoder Z pulse detection selection	V/F SVC FVC PMVF PMSVC PMFVC 0: OFF 1: ON (positive pulse) 2: ON (negative pulse)	1 (0~2)	
F02.33 (0x0221) STOP	Number of ABZ encoder pulse	V/F SVC FVC PMVF PMSVC PMFVC Set the number of ABZ encoder pulse.	1024 (1~10000)	
F02.34	Number of	V/F SVC FVC PMVF PMSVC PMFVC	2	

(0x0222) STOP	resolver poles	Set the number of resolver poles.	(2~128)	
F02.35 (0x0223) RUN	Encoder transmission ratio numerator	V/F SVC FVC PMVF PMSVC PMFVC Set the numerator of encoder transmission ratio.	1 (1~32767)	
F02.36 (0x0224) RUN	Encoder transmission ratio denominator	V/F SVC FVC PMVF PMSVC PMFVC Set the denominator of encoder transmission ratio.	1 (1~32767)	
F02.37 (0x0225) RUN	Encoder speed measurement filter time	V/F SVC FVC PMVF PMSVC PMFVC Set the filter time for encoder speed measurement.	1.0ms (0.0ms~100.0ms)	
F02.38 (0x0226) RUN	Encoder disconnection detection time	V/F SVC FVC PMVF PMSVC PMFVC Set the time required for encoder disconnection detection.	0.500s (0.100s~60.000s)	
F02.49 (0x0231) RUN	Encoder debug register	V/F SVC FVC PMVF PMSVC PMFVC LED"0": Monitor PG feedback under SVC mode 0: Invalid 1: Valid	0000 (0000~1111)	

Group F02.5x: Motor Application Parameters

Parameter Code (Address)	Name	Description	Default (Range)	Reference Source
F02.50 (0x0232) STOP	Stator resistance Start tuning function selection	V/F SVC FVC PMVF PMSVC PMFVC 0: Invalid 1: Turning without update >1: Turning with update	0 (0~3)	F02.5x
F02.51 (0x0233) RUN	Stator resistance Start tuning coefficient 1	V/F SVC FVC PMVF PMSVC PMFVC Stator resistance Start learning coefficient 1.	0 (0~1000)	
F02.52 (0x0234) RUN	Stator resistance Start tuning coefficient 2	V/F SVC FVC PMVF PMSVC PMFVC Stator resistance Start learning coefficient 2.	0 (-20.00%~20.00%)	
F02.53 (0x0235) RUN	Stator resistance Start tuning coefficient 3	V/F SVC FVC PMVF PMSVC PMFVC Stator resistance Start tuning coefficient 3.	0 (0~65535)	
F02.60 (0x023C) STOP	Magnetic pole search of synchronous motor	V/F SVC FVC PMVF PMSVC PMFV LED"0": Closed-loop vector 0: OFF 1: ON 2: ON, started only for the first time on power-on LED"00": Open-loop vector 0: OFF 1: ON 2: ON, started only for the first time on power-on LED"000": VF 0: OFF 1: ON 2: ON, started only for the first time power-on	0010 (0000~3223)	
F02.61 (0x023D) STOP	Pole search current setting	V/F SVC FVC PMVF PMSVC PMFVC Set the set value of the magnetic pole search current.	0.0% (0.0%~6553.5%)	

10.7 Group F03: Vector Control

Group F03.0x: Speed Loop

Parameter Code (Address)	Name	Description	Default (Range)	Reference Source
F03.00 (0x0300) RUN	ASR speed rigidity class	V/F SVC FVC PMVF PMSVC PMFVC Set the rigidity class. The higher the class, the better the speed rigidity.	32 (1~128)	F03.0x
F03.01 (0x0301) RUN	ASR speed rigidity mode	V/F SVC FVC PMVF PMSVC PMFVC Select the ASR speed rigidity mode.	0000 (0000~FFFF)	
F03.02 (0x0302) RUN	ASR (speed loop) proportional gain 1	V/F SVC FVC PMVF PMSVC PMFVC Set the ASR (speed loop) proportional gain 1.	10.00 (0.01~100.00)	
F03.03 (0x0303) RUN	ASR (speed loop) integral time 1	V/F SVC FVC PMVF PMSVC PMFVC Set the ASR (speed loop) integral time 1.	0.100s (0.000s~6.000s)	
F03.04 (0x0304) RUN	ASR filter time 1	V/F SVC FVC PMVF PMSVC PMFVC Set the ASR filter time 1.	0.0ms (0.0ms~100.0ms)	
F03.05 (0x0305) RUN	ASR switching frequency 1	V/F SVC FVC PMVF PMSVC PMFVC Set the ASR switching frequency 1.	0.00 Hz (0.00Hz~maximum frequency)	
F03.06 (0x0306) RUN	ASR (speed loop) proportional gain 2	V/F SVC FVC PMVF PMSVC PMFVC Set the ASR (speed loop) proportional gain 2.	10.00 (0.01~100.00)	
F03.07 (0x0307) RUN	ASR (speed loop) integral time 2	V/F SVC FVC PMVF PMSVC PMFVC Set the ASR (speed loop) integral time 2.	0.100s (0.000s~6.000s)	
F03.08 (0x0308) RUN	ASR filter time 2	V/F SVC FVC PMVF PMSVC PMFVC Set the ASR filter time 2.	0.0ms (0.0ms~100.0ms)	
F03.09 (0x0309) RUN	ASR switching frequency 2	V/F SVC FVC PMVF PMSVC PMFVC Set the ASR switching frequency 2.	0.00 Hz (0.00 Hz~maximum frequency)	

Group F03.1x: Current Loop and Torque Limit

Parameter Code (Address)	Name	Description	Default (Range)	Reference Source
F03.10 (0x030A) RUN	Current loop D-axis proportional gain	V/F SVC FVC PMVF PMSVC PMFVC Set the current loop D-axis proportional gain.	1.000 (0.001~4.000)	F03.1x

F03.11 (0x030B) RUN	Current loop D-axis integral gain	V/F SVC FVC PMVF PMSVC PMFVC Set the current loop D-axis integral gain.	1.000 (0.001~4.000)	
F03.12 (0x030C) RUN	Current loop Q-axis proportional gain	V/F SVC FVC PMVF PMSVC PMFVC Set the current loop Q-axis proportional gain.	1.000 (0.001~4.000)	
F03.13 (0x030D) RUN	Current loop Q-axis integral gain	V/F SVC FVC PMVF PMSVC PMFVC Set the current loop Q-axis integral gain.	1.000 (0.001~4.000)	
F03.15 (0x030F) RUN	Torque limit in motoring state	V/F SVC FVC PMVF PMSVC PMFVC Set the torque limit in motoring state.	250.0% (0.0%~400.0%)	
F03.16 (0x0310) RUN	Torque limit in power generation state	V/F SVC FVC PMVF PMSVC PMFVC Set the torque limit in power generation state.	250.0% (0.0%~400.0%)	
F03.17 (0x0311) RUN	Regenerative torque limit at low speed	V/F SVC FVC PMVF PMSVC PMFVC Set the regenerative torque limit at low speed.	0.0% (0.0%~400.0%)	
F03.18 (0x0312) RUN	Frequency amplitude for torque limit action at low speed	V/F SVC FVC PMVF PMSVC PMFVC Set the frequency amplitude for torque limit action at low speed.	6.00Hz (0.00Hz~30.00Hz)	
F03.19 (0x0313) RUN	Torque Limit selection	V/F SVC FVC PMVF PMSVC PMFVC LED "0": Select torque limit channel in motoring state. 0: Keypad digital given 1: Keypad potentiometer (optional external single-line keypad) 2: AI1 3: AI2 4: Reserved 5: PUL 6: RS485 communication (0x3014) 7: Option card LED "00": Select torque limit channel in power generation state. 0: Keypad digital given 1: Keypad potentiometer (optional external single-line keypad) 2: AI1 3: AI2 4: Reserved 5: PUL 6: RS485 communication (0x3015) 7: Option card LED "000": 0: C00.06 Display the torque limit value in motoring state 1: C00.06 Display the torque limit value in the power generation state LED "0000": Reserved	0000 (0000~0177)	

Group F03.2x: Torque Optimization Control

Parameter Code (Address)	Name	Description	Default (Range)	Reference Source
F03.20 (0x0314) RUN	Low frequency pull-in current of synchronous motor	V/F SVC FVC PMVF PMSVC PMFVC When the SVC of PM motor is activated, the higher the pull-in current, the higher the torque output.	20.0% (0.0%~50.0%)	F03.2x
F03.21 (0x0315) RUN	High frequency pull-in current of synchronous motor	V/F SVC FVC PMVF PMSVC PMFVC When the SVC of PM motor is activated, the higher the pull-in current, the higher the torque output.	10.0% (0.0%~50.0%)	
F03.22 (0x0316) RUN	Pull-in current frequency of synchronous motor	V/F SVC FVC PMVF PMSVC PMFVC The 100.0% corresponds to F01.10 [Maximum Frequency].	10.0% (0.0%~100.0%)	
F03.23 (0x0317) RUN	Slip compensation	V/F SVC FVC PMVF PMSVC PMFVC Set the slip compensation of motor.	100.0% (0.0%~250.0%)	
F03.24 (0x0318) RUN	Initial value of starting torque	V/F SVC FVC PMVF PMSVC PMFVC Set the initial value of starting torque.	0.0% (0.0%~250.0%)	

Group F03.3x: Flux Optimization

Parameter Code (Address)	Name	Description	Default (Range)	Reference Source
F03.30 (0x031E) RUN	Flux weakening feedforward coefficient	V/F SVC FVC PMVF PMSVC PMFVC Set the feed-forward coefficient of flux weakening.	10.0% (0.0%~500.0%)	F03.3x
F03.31 (0x031F) RUN	Flux weakening control gain	V/F SVC FVC PMVF PMSVC PMFVC Set the gain of flux weakening control.	10.0% (0.0%~500.0%)	
F03.32 (0x0320) RUN	Flux weakening current upper limit	V/F SVC FVC PMVF PMSVC PMFVC Set the upper limit of flux weakening current.	60.0% (0.0%~250.0%)	
F03.33 (0x0321) RUN	Flux weakening voltage coefficient	V/F SVC FVC PMVF PMSVC PMFVC Set the flux weakening voltage coefficient.	97.0% (0.0%~120.0%)	
F03.34 (0x0322) RUN	Shaft output power limit	V/F SVC FVC PMVF PMSVC PMFVC Set the output power limit of motor shaft.	250.0% (0.0%~400.0%)	
F03.35 (0x0323) RUN	over-excitation brake gain	V/F SVC FVC PMVF PMSVC PMFVC Set the over-excitation brake gain.	100.0% (0.0%~500.0%)	
F03.36 (0x0324) RUN	over-excitation brake limit	V/F SVC FVC PMVF PMSVC PMFVC Set the over-excitation brake limit.	100.0% (0.0%~250.0%)	
F03.37 (0x0325) RUN	Energy-saving running	V/F SVC FVC PMVF PMSVC PMFVC 0: OFF 1: ON	0 (0~1)	
F03.38 (0x0326) RUN	Lower excitation limit in energy-saving running	V/F SVC FVC PMVF PMSVC PMFVC Sets the lower excitation limit in energy-saving running.	50.0% (0.0%~80.0%)	
F03.39 (0x0327) RUN	Filter coefficient of energy-saving running	V/F SVC FVC PMVF PMSVC PMFVC Set the filter coefficient of energy-saving running.	0.010s (0.000s~6.000s)	

Group F03.4x~F03.5x: Torque Control

Parameter Code (Address)	Name	Description	Default (Range)	Reference Source
F03.40 (0x0328) RUN	Torque control selection	V/F SVC FVC PMVF PMSVC PMFVC 0: Limit torque by speed control 1: Limit speed by torque control	0 (0~1)	F03.4x
F03.41 (0x0329) RUN	Torque command given	V/F SVC FVC PMVF PMSVC PMFVC LED "0": Channel A 0: Digital setting 0: Keypad digital given 1: Keypad potentiometer (optional external single- line keypad) 2: Current/voltage analog AI1 3: Current/voltage analog AI2 4: Reserved 5: PUL 6: RS485 communication 7: Option card 8: Reserved 9: Given by tension calculation LED "00": Channel B LED "000": Mode 0: Channel A 1: Channel B 2: Channel A + Channel B 3: Channel A - Channel B 4: MIN (Channel A, Channel B) 5: MAX (Channel A, Channel B)	0000 (0000~0599)	
F03.42 (0x032A) RUN	Torque given by keypad digital	V/F SVC FVC PMVF PMSVC PMFVC Set the torque given.	0.0% (0.0%~100.0%)	
F03.43 (0x032B) RUN	Torque input lower limit	V/F SVC FVC PMVF PMSVC PMFVC Set the torque input lower limit.	0.00% (0.00%~ 100.00%)	
F03.44 (0x032C) RUN	Lower limit corresponding setting	V/F SVC FVC PMVF PMSVC PMFVC Set the lower limit corresponding value	0.00% (-250.00%~ 300.00%)	
F03.45 (0x032D) RUN	Torque input upper limit	V/F SVC FVC PMVF PMSVC PMFVC Set the upper limit of torque input.	100.00% (0.00%~ 100.00%)	
F03.46 (0x032E) RUN	Upper limit corresponding setting	V/F SVC FVC PMVF PMSVC PMFVC Set the corresponding value of the upper limit.	100.00% (-250.00%~ 300.00%)	
F03.47 (0x032F) RUN	Torque filter time	V/F SVC FVC PMVF PMSVC PMFVC Set the frequency amplitude for torque limit action at low speed.	0.100s (0.000s~ 6.000s)	
F03.52 (0x0334) RUN	Output torque upper limit	V/F SVC FVC PMVF PMSVC PMFVC Set the output torque upper limit.	150.0% (0.0%~300.0%)	
F03.53 (0x0335) RUN	Output torque lower limit	V/F SVC FVC PMVF PMSVC PMFVC Set the output torque lower limit.	0.0% (0.0%~300.0%)	
F03.54	Selection of	V/F SVC FVC PMVF PMSVC PMFVC	0	

(0x0336) RUN	torque control forward speed limit	0: Function code F03.56 1: Keypad potentiometer (optional external single-line keypad) × F03.56 2: AI1 × F03.56 3: AI2 × F03.56 4: Reserved 5: PUL × F03.56 6: RS485 communication × F03.56 7: Option card × F03.56 8: Reserved	(0~8)	
F03.55 (0x0337) RUN	Selection of torque control reverse speed limit	V/F SVC FVC PMVF PMSVC PMFVC 0: Function code F03.57 1: Keypad potentiometer (optional external single-line keypad) × F03.57 2: AI1 × F03.57 3: AI2 × F03.57 4: Reserved 5: PUL × F03.57 6: RS485 communication × F03.57 7: Option card × F03.57 8: Reserved	0 (0~8)	
F03.56 (0x0338) RUN	Torque control maximum forward speed limit	V/F SVC FVC PMVF PMSVC PMFVC Set the torque control maximum forward speed limit.	100.0% (0.0%~100.0%)	
F03.57 (0x0339) RUN	Torque control maximum reverse speed limit	V/F SVC FVC PMVF PMSVC PMFVC Set the torque control maximum reverse speed limit.	100.0% (0.0%~100.0%)	
F03.58 (0x033A) RUN	Given torque gain switching frequency	V/F SVC FVC PMVF PMSVC PMFVC Set the given torque gain switching frequency.	1.00Hz (0.00Hz~50.00Hz)	
F03.59 (0x033B) RUN	Given torque gain setting	V/F SVC FVC PMVF PMSVC PMFVC Set the given torque gain.	100.0% (0.0%~500.0%)	

Group F03.6x: PM High-frequency Injection

Parameter Code (Address)	Name	Description	Default (Range)	Reference Source
F03.60 (0x033C) STOP	High-frequency injection selection	V/F SVC FVC PMVF PMSVC PMFVC Activate in open-loop control of PM motor: select 0 when using a SPM motor; select 0-5 when using an IPM motor. 0: Disabled 1-5: Enabled. The greater the value, the higher the injection frequency.	0 (0~5)	F03.6x
F03.61 (0x033D) RUN	High-frequency injection voltage	V/F SVC FVC PMVF PMSVC PMFVC Injection voltage amplitude (relative to rated voltage). Get after auto-tuning. No need to modify.	10.0% (0.0%~100.0%)	
F03.62 (0x033E) RUN	High-frequency injection cutoff frequency	V/F SVC FVC PMVF PMSVC PMFVC The high-frequency injection action range. Relative to motor rated frequency. The high frequency injection is activated when the motor speed is less than this value.	10.0% (0.0%~20.0%)	

Group F03.7x: Position Compensation

Parameter Code (Address)	Name	Description	Default (Range)	Reference Source
F03.70 (0x0346) RUN	Position compensation control	V/F SVC FVC PMVF PMSVC PMFVC Under speed control, position compensation control is used to achieve zero servo or improve system rigidity.	50.0 (0~100.0)	F 03.7x
F03.71 (0x0347) RUN	Compensation gain	V/F SVC FVC PMVF PMSVC PMFVC Set the compensation gain.	0.0 (0.0~250.0)	
F03.72 (0x0348) RUN	Compensation range limiting	V/F SVC FVC PMVF PMSVC PMFVC Set the compensation limiting value.	0.0% (0.0%~100.0%)	
F03.73 (0x0349) RUN	Compensation range	V/F SVC FVC PMVF PMSVC PMFVC Set the compensation range.	0.0% (0.0%~100.0%)	

Group F03.8x: Extension Control

Parameter Code (Address)	Name	Description	Default (Range)	Reference Source
F03.80 (0x0350) RUN	MTPA gain of synchronous motor	V/F SVC FVC PMVF PMSVC PMFVC Set the MTPA gain of synchronous motor.	100.0% (0.0%~400.0%)	F03.8x
F03.81 (0x0351) RUN	MTPA filter time of synchronous motor	V/F SVC FVC PMVF PMSVC PMFVC Set the MTPA filter time of synchronous motor.	1.0ms (0.0ms~100.0ms)	

10.8 Group F04: V/F Control

Group F04.0x: V/F Control

Parameter Code (Address)	Name	Description	Default (Range)	Reference Source
F04.00	Linear V/F curve	V/F SVC FVC PMVF PMSVC PMFVC Select the type of V/F curve according to different	0	F04.0x

(0x0400) STOP	selection	load characteristics. 0: V/F straight curve; 1-9: 1.1-1.9 power V/F curves, respectively; 10: Square V/F curve; 11: Custom V/F curve;	(0~11)	
F04.01 (0x0401) RUN	Torque boost	V/F SVC FVC PMVF PMSVC PMFVC 0.0%: Automatic torque boost 0.1% - 30.0%: Manual torque boost	Depending on model (0.0%~30.0%)	
F04.02 (0x0402) RUN	Torque boost cutoff frequency	V/F SVC FVC PMVF PMSVC PMFVC Set the effective range of the torque boost function. The torque boost function will be cut off when the output frequency exceeds this value.	100.0% (0.0%~100.0%)	
F04.03 (0x0403) RUN	Slip compensation gain	V/F SVC FVC PMVF PMSVC PMFVC Set the slip compensation gain.	0.0% (0.0%~200.0%)	
F04.04 (0x0404) RUN	Slip compensation range limiting	V/F SVC FVC PMVF PMSVC PMFVC Set the slip compensation limiting value.	100.0% (0.0%~300.0%)	
F04.05 (0x0405) RUN	Slip compensation filter time	V/F SVC FVC PMVF PMSVC PMFVC To achieve the optimum effect, it is required to correctly enter the parameters on the motor's nameplate and implement parameter tuning when the slip compensation function is activated.	0.200s (0.000s~ 6.000s)	
F04.06 (0x0406) RUN	Oscillation suppression gain	V/F SVC FVC PMVF PMSVC PMFVC Adjust this value to suppress low frequency resonance. Avoid setting it too higher, or it will cause stability problems.	100.0% (0.0%~900.0%)	
F04.07 (0x0407) RUN	Oscillation suppression filter time	V/F SVC FVC PMVF PMSVC PMFVC Set the oscillation suppression filter time.	1.0s (0.0s~100.0s)	
F04.08 (0x0408) STOP	Output voltage percentage	V/F SVC FVC PMVF PMSVC PMFVC Set the output voltage percentage. 100% corresponds to the motor rated voltage.	100.0% (25.0%~ 120.0%)	

Group F04.1x: Custom V/F Curve

Parameter Code (Address)	Name	Description	Default (Range)	Reference Source
F04.10 (0x040A) STOP	Self-setting voltage V1	V/F SVC FVC PMVF PMSVC PMFVC Set the self-setting voltage V1.	3.0% (0.0%~100.0%)	F04.1x
F04.11 (0x040B) STOP	Self-setting frequency F1	V/F SVC FVC PMVF PMSVC PMFVC Set the self-setting frequency F1.	1.00 Hz (0.00 - maximum frequency)	
F04.12 (0x040C) STOP	Self-setting voltage V2	V/F SVC FVC PMVF PMSVC PMFVC Set the self-setting voltage V2.	28.0% (0.0%~100.0%)	
F04.13 (0x040D) STOP	Self-setting frequency F2	V/F SVC FVC PMVF PMSVC PMFVC Set the self-setting frequency F2.	10.00 Hz (0.00 - maximum frequency)	
F04.14 (0x040E) STOP	Self-setting voltage V3	V/F SVC FVC PMVF PMSVC PMFVC Set the self-setting voltage V3.	55.0% (0.0%~100.0%)	
F04.15 (0x040F) STOP	Self-setting frequency F3	V/F SVC FVC PMVF PMSVC PMFVC Set the self-setting frequency F3.	25.00 Hz (0.00 - maximum frequency)	
F04.16 (0x0410) STOP	Self-setting voltage V4	V/F SVC FVC PMVF PMSVC PMFVC Set the self-setting voltage V4.	78.0% (0.0%~100.0%)	
F04.17 (0x0411) STOP	Self-setting frequency F4	V/F SVC FVC PMVF PMSVC PMFVC Set the self-setting frequency F4.	37.50 Hz (0.00 - maximum frequency)	
F04.18 (0x0412) STOP	Self-setting voltage V5	V/F SVC FVC PMVF PMSVC PMFVC Set the self-setting voltage V5.	100.0% (0.0%~100.0%)	
F04.19 (0x0413) STOP	Self-setting frequency F5	V/F SVC FVC PMVF PMSVC PMFVC Set the self-setting frequency F5.	50.00 Hz (0.00 - maximum frequency)	

Group F04.2x: V/F Separation Control

Parameter Code (Address)	Name	Description	Default (Range)	Reference Source
F04.20 (0x0414) RUN	V/F separation voltage given	V/F SVC FVC PMVF PMSVC PMFVC LED "0": Channel A LED "00": Channel B 0: Voltage percentage 1: Keypad potentiometer 2: Analog AI1 3: Analog AI2 4: Reserved 5: Terminal pulse PUL 6: PID output 7: RS485 communication 8: Option card 9: Voltage digital LED "000": Mode	0000 (0000~0599)	F04.2x

		0: Channel A 2: A + B 4: MIN (A, B)	1: Channel B 3: A-B 5: MAX (A, B)		
F04.21 (0x0415) RUN	V/F separation output voltage percentage setting	V/F SVC FVC PMVF PMSVC PMFVC Set the V/F separation output voltage percentage. 100.0% corresponds to the motor rated voltage.		0.00% (0.00%~110.00%)	
F04.22 (0x0416) RUN	V/F separation voltage acceleration time	V/F SVC FVC PMVF PMSVC PMFVC Set the V/F separation voltage acceleration time.		10.00s (0.00s~100.00s)	
F04.23 (0x0417) RUN	V/F separation voltage deceleration time	V/F SVC FVC PMVF PMSVC PMFVC Set the V/F separation voltage deceleration time.		10.00s (0.00s~100.00s)	
F04.24 (0x0418) RUN	V/F separation stop mode	V/F SVC FVC PMVF PMSVC PMFVC Set the V/F separation stop mode. 0: The acceleration/deceleration of output voltage is independent of the acceleration/deceleration of output frequency. 1: The output frequency drops again after the output voltage drops to 0 V.		0 (0~1)	
F04.25 (0x0419) RUN	V/F separation voltage digital setting	V/F SVC FVC PMVF PMSVC PMFVC Set the V/F separation voltage value.		0.00V (0.00V~600.00V)	

Group F04.3x: V/F Energy-Saving Control

Parameter Code (Address)	Name	Description	Default (Range)	Reference Source
F04.30 (0x041E) STOP	Automatic energy-saving control	V/F SVC FVC PMVF PMSVC PMFVC 0: OFF 1: ON	0 (0~1)	F04.3x
F04.31 (0x041F) STOP	Frequency lower limit of the energy-saving voltage drop	V/F SVC FVC PMVF PMSVC PMFVC Set the frequency lower limit of the energy-saving voltage drop.	15.0Hz (0.0Hz~50.0Hz)	
F04.32 (0x0420) STOP	Voltage lower limit of the energy-saving voltage drop	V/F SVC FVC PMVF PMSVC PMFVC Set the voltage lower limit of the energy-saving voltage drop.	50.0% (20.0%~100.0%)	
F04.33 (0x0421) RUN	Voltage regulation rate of the energy-saving voltage drop	V/F SVC FVC PMVF PMSVC PMFVC Set the voltage regulation rate of the energy-saving voltage drop.	0.010V/ms (0.000V/ms~0.2000V/ms)	
F04.34 (0x0422) RUN	Energy-saving voltage recovery rate	V/F SVC FVC PMVF PMSVC PMFVC Sets the energy-saving voltage recovery rate.	0.200V/ms (0.000V/ms~2.000V/ms)	
F04.35 (0x0423) RUN	Over-excitation coefficient	V/F SVC FVC PMVF PMSVC PMFVC It is activated when the LED "00" of F10.11 is not set as 0. The output voltage increases with the increase of bus voltage at the same output frequency.	64 (0~200)	

10.9 Group F05: Input Terminals

Group F05.0x: Functions of Digital Input Terminals (X1-X10)

Parameter Code (Address)	Name	Description	Default (Range)	Reference Source
F05.00 (0x0500) STOP	Function selection of terminal X1	V/F SVC FVC PMVF PMSVC PMFVC See the functions of terminal X for details.	1 (0~95)	F05.0x
F05.01 (0x0501) STOP	Function selection of terminal X2	V/F SVC FVC PMVF PMSVC PMFVC See the functions of terminal X for details.	2 (0~95)	
F05.02 (0x0502) STOP	Function selection of terminal X3	V/F SVC FVC PMVF PMSVC PMFVC See the functions of terminal X for details.	4 (0~95)	
F05.03 (0x0503) STOP	Function selection of terminal X4	V/F SVC FVC PMVF PMSVC PMFVC See the functions of terminal X for details.	5 (0~95)	
F05.04 (0x0504) STOP	Function selection of terminal X5	V/F SVC FVC PMVF PMSVC PMFVC See the functions of terminal X for details.	6 (0~95)	
F05.05 (0x0505) STOP	Function selection of terminal X6	V/F SVC FVC PMVF PMSVC PMFVC See the functions of terminal X for details.	0 (0~95)	
F05.06 (0x0506) STOP	Function selection of terminal X7	V/F SVC FVC PMVF PMSVC PMFVC See the functions of terminal X for details.	0 (0~95)	
F05.07 (0x0507) STOP	Function selection of terminal X8	V/F SVC FVC PMVF PMSVC PMFVC See the functions of terminal X for details.	0 (0~95)	
F05.08 (0x0508) STOP	Function selection of terminal X9	V/F SVC FVC PMVF PMSVC PMFVC See the functions of terminal X for details.	0 (0~95)	
F05.09 (0x0509) STOP	Function selection of terminal X10	V/F SVC FVC PMVF PMSVC PMFVC See the functions of terminal X for details.	0 (0~95)	

Refer to the table below when setting the functions of F05.0x [Function Selection of Multi-Functional Input Terminals].

Set Point	Function	Set Point	Function
0	No function.	33	Acceleration/deceleration time selection terminal 2.
1	Forward running.	34	Acceleration/deceleration pause
2	Reverse running.	35	Swing frequency on.
3	3-wire running control (Xi).	36	Swing frequency pause
4	Forward jogging.	37	Swing frequency reset.
5	Reverse jogging.	38	Selection of keypad keys and self-test display.
6	Free stop	39	X5 or X10 (extension terminal) frequency measurement.
7	Emergency stop	40	Timer trigger terminal.
8	Fault reset.	41	Timer reset terminal.
9	External fault input.	42	Counter clock input terminal.

10	Frequency UP.	43	Counter reset terminal.
11	Frequency DW.	44	DC brake command.
12	Frequency UP/DW reset.	45	Pre-excitation command terminal.
13	Switch from Channel A to channel B.	46	Reserved.
14	Switch the frequency channel combination to A.	47	Reserved.
15	Switch the frequency channel combination to B.	48	Switch the command channel to keypad.
16	Multi-speed terminal 1.	49	Switch the command channel to terminal.
17	Multi-speed terminal 2.	50	Switch the command channel to communication.
18	Multi-speed terminal 3.	51	Switch the command channel to extension card.
19	Multi-speed terminal 4.	52	Running disable.
20	PID control cancel.	53	Forward disable.
21	PID control pause.	54	Reverse disable.
22	PID characteristic switch	55~59	Reserved.
23	PID parameter switch	60	Speed torque control switch.
24	PID setting switch 1.	61~79	Reserved.
25	PID setting switch 2.	88	Roll diameter reset.
26	PID setting switch 3.	89	Initial roll diameter selection terminal 1.
27	PID feedback switch 1.	90	Initial roll diameter selection terminal 2.
28	PID feedback switch 2.	91	Linear speed selection terminal.
29	PID feedback switch 3.	92	Tension given channel switch
30	Program running (PLC) pause.	93	Reserved.
31	Program running (PLC) restart	94	Winding/unwinding switch
32	Acceleration/deceleration time selection terminal 1.	95	Pre-drive terminal.

Group F05.1x: X1-X5 Detection Delay

Parameter Code (Address)	Name	Description	Default (Range)	Reference Source
F05.10 (0x050A) RUN	X1 activation detection delay	V/F SVC FVC PMVF PMSVC PMFVC The delay time taken by output terminal X1 from deactivation to activation.	0.010s (0.000s~6.000s)	F05.1x
F05.11 (0x050B) RUN	X1 deactivation detection delay	V/F SVC FVC PMVF PMSVC PMFVC The delay time taken by output terminal X1 from activation to deactivation.	0.010s (0.000s~6.000s)	
F05.12 (0x050C) RUN	X2 activation detection delay	V/F SVC FVC PMVF PMSVC PMFVC The delay time taken by output terminal X2 from deactivation to activation.	0.010s (0.000s~6.000s)	
F05.13 (0x050D) RUN	X2 deactivation detection delay	V/F SVC FVC PMVF PMSVC PMFVC The delay time taken by output terminal X2 from activation to deactivation.	0.010s (0.000s~6.000s)	
F05.14 (0x050E) RUN	X3 activation detection delay	V/F SVC FVC PMVF PMSVC PMFVC The delay time taken by output terminal X3 from deactivation to activation.	0.010s (0.000s~6.000s)	
F05.15 (0x050F) RUN	X3 deactivation detection delay	V/F SVC FVC PMVF PMSVC PMFVC The delay time taken by output terminal X3 from activation to deactivation.	0.010s (0.000s~6.000s)	
F05.16 (0x0510)	X4 activation detection delay	V/F SVC FVC PMVF PMSVC PMFVC The delay time taken by output terminal X4 from	0.010s (0.000s~	

RUN		deactivation to activation.	6.000s)	
F05.17 (0x0511) RUN	X4 deactivation detection delay	V/F SVC FVC PMVF PMSVC PMFVC The delay time taken by output terminal X4 from activation to deactivation.	0.010s (0.000s~ 6.000s)	
F05.18 (0x0512) RUN	X5 activation detection delay	V/F SVC FVC PMVF PMSVC PMFVC The delay time taken by output terminal X5 from deactivation to activation.	0.010s (0.000s~ 6.000s)	
F05.19 (0x0513) RUN	X5 deactivation detection delay	V/F SVC FVC PMVF PMSVC PMFVC The delay time taken by output terminal X5 from activation to deactivation.	0.010s (0.000s~ 6.000s)	

Group F05.2x: Digital Input Terminal Action Selection

Parameter Code (Address)	Name	Description	Default (Range)	Reference Source
F05.20 (0x0514) STOP	Terminal control running mode	V/F SVC FVC PMVF PMSVC PMFVC 0: 2-wire control 1 1: 2-wire control 2 2: 3-wire control 1 3: 3-wire control 2	0 (0~3)	F05.2x
F05.22 (0x0516) RUN	Terminal X1-X4 characteristic selection	V/F SVC FVC PMVF PMSVC PMFVC 0: Activated when closed 1: Activated when open LED "0": X1 terminal LED "00": X2 terminal LED "000": X3 terminal LED "0000": X4 terminal	0000 (0000~1111)	
F05.23 (0x0517) RUN	Terminal X5-X8 characteristic selection	V/F SVC FVC PMVF PMSVC PMFVC 0: Activated when closed 1: Activated when open LED "0": X5 terminal LED "00": X6 terminal LED "000": X7 terminal LED "0000": X8 terminal	0000 (0000~1111)	
F05.24 (0x0518) RUN	Terminal X9- X10 characteristic selection	V/F SVC FVC PMVF PMSVC PMFVC 0: Activated when closed 1: Activated when open LED "0": X9 terminal LED "00": X10 terminal LED "000": Reserved LED "0000": Reserved	0000 (0000~0011)	
F05.25 (0x0519) STOP	Terminal UP/DW control selection	V/F SVC FVC PMVF PMSVC PMFVC 0: Store frequency during power-off 1: Reset frequency during power-off 2: Adjustable during running; reset during stop	0 (0~2)	
F05.26 (0x051A) RUN	Acceleration/de celeration rate of the terminal UP/DW control frequency	V/F SVC FVC PMVF PMSVC PMFVC Set the acceleration/deceleration rate of the terminal UP/DW control frequency.	0.50Hz/s (0.01Hz/s~ 50.00Hz/s)	
F05.27 (0x051B) RUN	Deceleration time of emergency stop by terminal	V/F SVC FVC PMVF PMSVC PMFVC Set the deceleration time of emergency stop by terminal.	1.00s (0.01s~ 650.00s)	

Group F05.3x: PUL Terminal

Parameter Code (Address)	Name	Description	Default (Range)	Reference Source
F05.30 (0x051E) STOP	PUL port signal source	V/F SVC FVC PMVF PMSVC PMFVC 0: X5 (maximum 5.000 kHz) 1: Extension port X10 (maximum 100.00 kHz) 2: X5 (maximum 100.00 kHz)	0 (0~2)	F05.3x
F05.31 (0x051F) RUN	Minimum frequency of PUL input	V/F SVC FVC PMVF PMSVC PMFVC Set the minimum frequency acceptable for PUL. Any frequency signal below this value will be processed as minimum frequency by the drive. 0.00 kHz - 50.000 kHz (F2.27 is set as 0). 0.00 kHz - 100.00 kHz (F2.27 is set as 1 or 2).	0.000kHz (0.000kHz~500.00kHz)	
F05.32 (0x0520) RUN	PUL minimum frequency corresponding setting	V/F SVC FVC PMVF PMSVC PMFVC Set the percentage of the set value.	0.00% (0.00%~100.00%)	
F05.33 (0x0521) RUN	Maximum frequency of PUL input	V/F SVC FVC PMVF PMSVC PMFVC Set the maximum frequency acceptable for PUL. Any frequency signal above this value will be processed as maximum frequency by the drive. 0.00 kHz - 50.000 kHz (F2.27 is set as 0). 0.00 kHz - 100.00 kHz (F2.27 is set as 1 or 2).	5.000kHz (0.000kHz~500.00k Hz)	
F05.34 (0x0522) RUN	PUL maximum frequency corresponding setting	V/F SVC FVC PMVF PMSVC PMFVC Set the percentage of the set value.	100.00% (0.00%~100.00%)	
F05.35 (0x0523) RUN	PUL filter time	V/F SVC FVC PMVF PMSVC PMFVC Define the level of filtering input pulse signals to eliminate interference signals.	0.100s (0.000s~9.000s)	
F05.36 (0x0524) RUN	PUL cutoff frequency	V/F SVC FVC PMVF PMSVC PMFVC Any frequency lower than this value will not be recognized and will be processed as 0 Hz by the drive.	0.010kHz (0.000kHz~1.000kHz)	

Group F05.4x: Analog Input (AI) Type Processing

Parameter Code (Address)	Name	Description	Default (Range)	Reference Source
F05.41 (0x0529) RUN	AI1 input signal type	V/F SVC FVC PMVF PMSVC PMFVC 0: Voltage 0 V - 10.00 V 1: Current 0 mA - 20.00 mA	0 (0~1)	F05.4x
F05.42 (0x052A) RUN	AI2 input signal type	V/F SVC FVC PMVF PMSVC PMFVC 0: Voltage 0 V - 10.00 V 1: Current 0 mA - 20.00 mA	0 (0~1)	
F05.43 (0x052B) RUN	Analog value input curve selection	V/F SVC FVC PMVF PMSVC PMFVC 0: Straight line (default) 1: Curve 1 2: Curve 2 LED "0": AI1 LED "00": AI2 (selecting voltage or current input with jumpers) LED "000": Reserved	0000 (0000~0022)	

LED "0000": Reserved

Group F05.5x: Analog Input (AI) Linear Processing

Parameter Code (Address)	Name	Description	Default (Range)	Reference Source
F05.50 (0x0532) RUN	AI1 lower limit	V/F SVC FVC PMVF PMSVC PMFVC Define the signal received by the terminal. Any voltage signal below this lower limit is processed as lower limit.	0.0% (0.0%~100.0%)	F05.5x
F05.51 (0x0533) RUN	AI1 lower limit corresponding setting	V/F SVC FVC PMVF PMSVC PMFVC Set the percentage of the set value.	0.00% (-100.00%~100.00%)	
F05.52 (0x0534) RUN	AI1 upper limit	V/F SVC FVC PMVF PMSVC PMFVC Define the signal received by the terminal. Any voltage signal above this upper limit is processed as upper limit.	100.0% (0.0%~100.0%)	
F05.53 (0x0535) RUN	AI1 upper limit corresponding setting	V/F SVC FVC PMVF PMSVC PMFVC Set the percentage of the set value.	100.00% (-100.00%~100.00%)	
F05.54 (0x0536) RUN	AI1 filter time	V/F SVC FVC PMVF PMSVC PMFVC Define the level of filtering analog signals to eliminate interference signals.	0.100s (0.000s~6.000s)	
F05.55 (0x0537) RUN	AI2 lower limit	V/F SVC FVC PMVF PMSVC PMFVC Define the signal received by the terminal. Any voltage signal below this lower limit is processed as lower limit.	0.0% (0.0%~100.0%)	
F05.56 (0x0538) RUN	AI2 lower limit corresponding setting	V/F SVC FVC PMVF PMSVC PMFVC Set the percentage of the set value.	0.00% (-100.00%~100.00%)	
F05.57 (0x0539) RUN	AI2 upper limit	V/F SVC FVC PMVF PMSVC PMFVC Define the signal received by the terminal. Any voltage signal above this upper limit is processed as upper limit.	100.0% (0.0%~100.0%)	
F05.58 (0x053A) RUN	AI2 upper limit corresponding setting	V/F SVC FVC PMVF PMSVC PMFVC Set the percentage of the set value.	100.00% (-100.00%~100.00%)	
F05.59 (0x053B) RUN	AI2 filter time	V/F SVC FVC PMVF PMSVC PMFVC Define the level of filtering analog signals to eliminate interference signals.	0.100s (0.000s~6.000s)	

Group F05.6x: AI Curve 1 Processing

Parameter Code (Address)	Name	Description	Default (Range)	Reference Source
F05.60 (0x053C) RUN	Curve 1 lower limit	V/F SVC FVC PMVF PMSVC PMFVC Set the lower limit value of curve 1.	0.0% (0.0%~100.0%)	F05.6x
F05.61 (0x053D) RUN	Curve 1 lower limit corresponding setting	V/F SVC FVC PMVF PMSVC PMFVC Set the percentage of the corresponding setting.	0.00% (-100.00%~100.00%)	
F05.62 (0x053E) RUN	Input voltage of inflexion point 1 of curve 1	V/F SVC FVC PMVF PMSVC PMFVC Set the input voltage of inflexion point 1 of curve 1.	30.0% (0.0%~100.0%)	

F05.63 (0x053F) RUN	Corresponding setting of inflection point 1 of curve 1	V/F SVC FVC PMVF PMSVC PMFVC Set the percentage of the corresponding setting.	30.00% (-100.00%~100.00%)	
F05.64 (0x0540) RUN	Input voltage of inflexion point 2 of curve 1	V/F SVC FVC PMVF PMSVC PMFVC Set the input voltage of inflection point 2 of curve 1.	60.0% (0.0%~100.0%)	
F05.65 (0x0541) RUN	Corresponding setting of inflection Point 2 of Curve 1	V/F SVC FVC PMVF PMSVC PMFVC Set the percentage of the corresponding setting.	60.00% (-100.00%~100.00%)	
F05.66 (0x0542) RUN	Curve 1 upper limit	V/F SVC FVC PMVF PMSVC PMFVC Set the upper limit value of curve 1.	100.0% (0.0%~100.0%)	
F05.67 (0x0543) RUN	Curve 1 upper limit corresponding setting	V/F SVC FVC PMVF PMSVC PMFVC Set the percentage of the corresponding setting.	100.00% (-100.00%~100.00%)	

Group F05.7x: AI Curve 2 Processing

Parameter Code (Address)	Name	Description	Default (Range)	Reference Source
F05.70 (0x0546) RUN	Curve 2 lower limit	V/F SVC FVC PMVF PMSVC PMFVC Set the lower limit of curve 2.	0.0% (0.0%~100.0%)	F05.7x
F05.71 (0x0547) RUN	Curve 2 lower limit corresponding setting	V/F SVC FVC PMVF PMSVC PMFVC Set the percentage of the corresponding setting.	0.00% (-100.00%~100.00%)	
F05.72 (0x0548) RUN	Input voltage of inflexion point 1 of curve 2	V/F SVC FVC PMVF PMSVC PMFVC Set the input voltage of inflection point 1 of curve 2.	30.0% (0.0%~100.0%)	
F05.73 (0x0549) RUN	Corresponding setting of inflection point 1 of curve 2	V/F SVC FVC PMVF PMSVC PMFVC Set the percentage of the corresponding setting.	30.00% (-100.00%~100.00%)	
F05.74 (0x054A) RUN	Input voltage of inflexion point 2 of curve 2	V/F SVC FVC PMVF PMSVC PMFVC Set the input voltage of inflection point 2 of curve 2.	60.0% (0.0%~100.0%)	
F05.75 (0x054B) RUN	Corresponding setting of inflection point 2 of curve 2	V/F SVC FVC PMVF PMSVC PMFVC Set the percentage of the corresponding setting.	60.00% (-100.00%~100.00%)	
F05.76 (0x054C) RUN	Curve 2 upper limit	V/F SVC FVC PMVF PMSVC PMFVC Set the upper limit value of curve 2.	100.0% (0.0%~100.0%)	
F05.77 (0x054D) RUN	Curve 2 upper limit corresponding setting	V/F SVC FVC PMVF PMSVC PMFVC Set the percentage of the corresponding setting.	100.00% (-100.00%~100.00%)	

Group F05.8x: AI as Digital Input Terminals

Parameter Code (Address)	Name	Description	Default (Range)	Reference Source
F05.80 (0x0550) RUN	Characteristic selection of AI as digital input terminal	V/F SVC FVC PMVF PMSVC PMFVC 0: Active low. 1: Active high. LED "0": AI1 LED "00": AI2 LED "000": Reserved LED "0000": Reserved	0000 (0000~0011)	F05.8x
F05.81 (0x0551) STOP	Function selection of AI1 terminal (as X)	V/F SVC FVC PMVF PMSVC PMFVC See the functions of terminal X.	0 (0~95)	
F05.82 (0x0552) RUN	High level setting of AI1	V/F SVC FVC PMVF PMSVC PMFVC The input is high level if the input is higher than the high level setting.	70.00% (0.00%~100.00%)	
F05.83 (0x0553) RUN	Low level setting of AI1	V/F SVC FVC PMVF PMSVC PMFVC The input is low level if the input is lower than the low level setting.	30.00% (0.00%~100.00%)	
F05.84 (0x0554) STOP	Function selection of AI2 terminal (as X)	V/F SVC FVC PMVF PMSVC PMFVC See the functions of terminal X.	0 (0~95)	
F05.85 (0x0555) RUN	High level setting of AI2	V/F SVC FVC PMVF PMSVC PMFVC The input is high level if the input is higher than the high level setting.	70.00% (0.00%~100.00%)	
F05.86 (0x0556) RUN	Low level setting of AI2	V/F SVC FVC PMVF PMSVC PMFVC The input is low level if the input is lower than the low level setting.	30.00% (0.00%~100.00%)	

10.10 Group F06: Output Terminals

Group F06.0x: AO Output (Analog, Frequency)

Parameter Code (Address)	Name	Description	Default (Range)	Reference Source
F06.00 (0x0600) RUN	AO output mode selection	V/F SVC FVC PMVF PMSVC PMFVC 0: 0 V - 10 V 1: 4.00 mA ~ 20.00 mA 2: 0.00 mA ~ 20.00 mA 3: FM frequency pulse output	0 (0~3)	F06.0x
F06.01 (0x0601) RUN	AO output selection	V/F SVC FVC PMVF PMSVC PMFVC 0: Given frequency 1: Output frequency 2: Output current 3: Input voltage 4: Output voltage 5: Mechanical speed 6: Given torque 7: Output torque 8: PID given value 9: PID feedback value 10: Output power	0 (0~19)	

		11: Bus voltage 12: AI1 input value 13: AI2 input value 14: Reserved 15: PUL input value 16: Module temperature 1 17: Module temperature 2 18: 485 communication given 19: Virtual terminal vY1		
F06.02 (0x0602) RUN	AO output gain	V/F SVC FVC PMVF PMSVC PMFVC Adjust the value of terminal analog output.	100.0% (0.0%~300.0%)	
F06.03 (0x0603) RUN	AO output bias	V/F SVC FVC PMVF PMSVC PMFVC Set the AO output bias. Adjust the zero point of terminal output.	0.0% (-10.0%~10.0%)	
F06.04 (0x0604) RUN	AO output filtering	V/F SVC FVC PMVF PMSVC PMFVC Define the level of filtering analog signals to eliminate interference signals.	0.010s (0.000s~6.000s)	
F06.05 (0x0605) RUN	AO as lower limit of FM frequency output	V/F SVC FVC PMVF PMSVC PMFVC Set the lower limit of output signal.	0.20kHz (0.00kHz~100.00kHz)	
F06.06 (0x0606) RUN	AO as upper limit of FM frequency output	V/F SVC FVC PMVF PMSVC PMFVC Set the upper limit of FM frequency output.	50.00kHz (0.00kHz~100.00kHz)	

Group F06.1x: Extended AO Output

Parameter Code (Address)	Name	Description	Default (Range)	Reference Source
F06.10 (0x060A) RUN	Extended AO output mode selection	V/F SVC FVC PMVF PMSVC PMFVC 0: 0 V - 10 V 1: 4.00 mA ~ 20.00 mA 2: 0.00 mA ~ 20.00 mA 3: Reserved	0 (0~3)	F06.1x
F06.11 (0x060B) RUN	Extended AO output value selection	V/F SVC FVC PMVF PMSVC PMFVC The selection of extended AO output value. The same as the selection in F06.01.	1 (0~19)	
F06.12 (0x060C) RUN	Extended AO output gain	V/F SVC FVC PMVF PMSVC PMFVC Adjust the value of terminal output.	100.0% (0.0%~300.0%)	
F06.13 (0x060D) RUN	Extended AO analog output bias	V/F SVC FVC PMVF PMSVC PMFVC Adjust the zero point of terminal output.	0.0% (-10.0%~10.0%)	
F06.14 (0x060E) RUN	Extended AO output filtering	V/F SVC FVC PMVF PMSVC PMFVC Define the level of filtering analog signals to eliminate interference signals.	0.010s (0.000s~6.000s)	

Group F06.2x~F06.3x: Digital and Relay Output

Parameter Code (Address)	Name	Description	Default (Range)	Reference Source
F06.20 (0x0614) RUN	Output terminal polarity selection	V/F SVC FVC PMVF PMSVC PMFVC 0: Positive polarity 1: Negative polarity LED "0": Y terminal LED "00": Relay output terminal 1 LED "000": Extended terminal Y LED "0000": Extended relay output terminal	0000 (0000~1111)	F06.2x
F06.21 (0x0615) RUN	Output terminal Y	V/F SVC FVC PMVF PMSVC PMFVC See the functions of terminal Y.	1 (0~63)	
F06.22 (0x0616) RUN	Relay 1 output (TA-TB-TC)	V/F SVC FVC PMVF PMSVC PMFVC See the functions of terminal Y.	4 (0~63)	
F06.23 (0x0617) RUN	Extended output terminal Y1	V/F SVC FVC PMVF PMSVC PMFVC See the functions of terminal Y.	0 (0~63)	
F06.24 (0x0618) RUN	Extended relay 2 output (TA-TB-TC)	V/F SVC FVC PMVF PMSVC PMFVC See the functions of terminal Y.	0 (0~31)	
F06.25 (0x0619) RUN	Delay when Y outputs ON	V/F SVC FVC PMVF PMSVC PMFVC Set the ON delay for Y output.	0.010s (0.000s~60.000s)	
F06.26 (0x061A) RUN	Delay when relay 1 outputs ON	V/F SVC FVC PMVF PMSVC PMFVC Set the ON delay for relay 1 output.	0.010s (0.000s~60.000s)	
F06.27 (0x061B) RUN	Delay when extended Y outputs ON	V/F SVC FVC PMVF PMSVC PMFVC Set the ON delay for Extended Y output	0.010s (0.000s~60.000s)	

F06.28 (0x061C) RUN	Delay when extended relay 2 outputs ON	V/F SVC FVC PMVF PMSVC PMFVC Set the ON delay for Extended relay 2 output	0.010s (0.000s~60.000s)	
F06.29 (0x061D) RUN	Delay when Y outputs OFF	V/F SVC FVC PMVF PMSVC PMFVC Set the OFF delay for Y output	0.010s (0.000s~60.000s)	
F06.30 (0x061E) RUN	Delay when relay 1 outputs OFF	V/F SVC FVC PMVF PMSVC PMFVC Set the OFF delay for relay 1 output.	0.010s (0.000s~60.000s)	
F06.31 (0x061F) RUN	Delay when extended Y outputs OFF	V/F SVC FVC PMVF PMSVC PMFVC Set the OFF delay for extended Y1 output	0.010s (0.000s~60.000s)	
F06.32 (0x0620) RUN	Delay when extended relay 2 outputs OFF	V/F SVC FVC PMVF PMSVC PMFVC Set the OFF delay for extended relay 2 output	0.010s (0.000s~60.000s)	

Group F06.4x: Frequency Detection

Parameter Code (Address)	Name	Description	Default (Range)	Reference Source
F06.40 (0x0628) RUN	Frequency detection value 1	V/F SVC FVC PMVF PMSVC PMFVC Set frequency detection value 1.	2.00 Hz (0.00 Hz - maximum frequency)	F06.4x
F06.41 (0x0629) RUN	Frequency detection range 1	V/F SVC FVC PMVF PMSVC PMFVC Set frequency detection range 1.	1.00 Hz (0.00 Hz - maximum frequency)	
F06.42 (0x062A) RUN	Frequency detection value 2	V/F SVC FVC PMVF PMSVC PMFVC Set frequency detection value 2.	2.00 Hz (0.00 Hz - maximum frequency)	
F06.43 (0x062B) RUN	Frequency detection range 2	V/F SVC FVC PMVF PMSVC PMFVC Set frequency detection range 2.	1.00 Hz (0.00 Hz - maximum frequency)	
F06.44 (0x062C) RUN	Detection range for the given frequency arrival	V/F SVC FVC PMVF PMSVC PMFVC Set the detection range for the given frequency arrival.	2.00 Hz (0.00 Hz - maximum frequency)	

Group F06.5x: Monitoring Parameter Comparator Output

Parameter Code (Address)	Name	Description	Default (Range)	Reference Source
F06.50 (0x0632) RUN	Comparator 1 monitor selection	V/F SVC FVC PMVF PMSVC PMFVC LED "0" and LED "00": Set yy in monitoring parameter number Cxx.yy 00~63 LED "000" and LED "0000"s: Set xx in monitoring parameter number Cxx.yy 00~07	0001 (0000~0763)	F06.5x
F06.51 (0x0633)	Comparator 1 upper limit	V/F SVC FVC PMVF PMSVC PMFVC Set the upper limit of comparator 1.	(Determined by F06.50)	

RUN				
F06.52 (0x0634) RUN	Comparator 1 lower limit	V/F SVC FVC PMVF PMSVC PMFVC Set the lower limit of comparator 1.	(Determined by F06.50)	
F06.53 (0x0635) RUN	Comparator 1 offset	V/F SVC FVC PMVF PMSVC PMFVC Set the offset value of comparator 1.	(Determined by F06.50)	
F06.54 (0x0636) RUN	Operation selection while transmitting CP1	V/F SVC FVC PMVF PMSVC PMFVC 0: Continue running (digital terminal output only) 1: Alarm and free stop 2: Warning and keep running 3: Forced stop	0 (0~3)	
F06.55 (0x0637) RUN	Comparator 2 monitor selection	V/F SVC FVC PMVF PMSVC PMFVC LED "0" and LED "00"s: Set yy in monitoring parameter number Cxx.yy 00-63 LED "000" and LED "0000"s: Set xx in monitoring parameter number Cxx.yy 00-07	0002 (0000~0763)	
F06.56 (0x0638) RUN	Comparator 2 upper limit	V/F SVC FVC PMVF PMSVC PMFVC Set the lower limit of comparator 2.	(Depending on F06.55)	
F06.57 (0x0639) RUN	Comparator 2 lower limit	V/F SVC FVC PMVF PMSVC PMFVC Set the upper limit of comparator 2.	(Depending on F06.55)	
F06.58 (0x063A) RUN	Comparator 2 offset	V/F SVC FVC PMVF PMSVC PMFVC Set the offset value of comparator 2.	(Depending on F06.55)	
F06.59 (0x063B) RUN	Operation selection while transmitting CP2	V/F SVC FVC PMVF PMSVC PMFVC 0: Continue running (digital terminal output only) 1: Alarm and free stop 2: Warning and keep running 3: Forced stop	0 (0~3)	

Group F06.6x~Group F06.7x: Virtual Input and Output Terminals

Parameter Code (Address)	Name	Description	Default (Range)	Reference Source
F06.60 (0x063C) STOP	Function selection of virtual terminal vX1	V/F SVC FVC PMVF PMSVC PMFVC See the functions of terminal X.	0 (0~95)	F06.6x
F06.61 (0x063D) STOP	Function selection of virtual terminal vX2	V/F SVC FVC PMVF PMSVC PMFVC See the functions of terminal X.	0 (0~95)	
F06.62 (0x063E) STOP	Function selection of virtual terminal vX3	V/F SVC FVC PMVF PMSVC PMFVC See the functions of terminal X.	0 (0~95)	
F06.63 (0x063F) STOP	Function selection of virtual terminal vX4	V/F SVC FVC PMVF PMSVC PMFVC See the functions of terminal X.	0 (0~95)	
F06.64 (0x0640) RUN	Activation state source of terminal vX	V/F SVC FVC PMVF PMSVC PMFVC 0: Internally connected to virtual vYn 1: Connected to physical terminal Xn 2: Whether the function code setting is activated LED "0": Virtual vX1 LED "00": Virtual vX2 LED "000": Virtual vX3 LED "0000": Virtual vX4	0000 (0000~2222)	
F06.65 (0x0641) RUN	Activation state of function code setting for virtual terminal vX	V/F SVC FVC PMVF PMSVC PMFVC 0: Deactivated; 1: Activated LED "0": Virtual vX1 LED "00": Virtual vX2 LED "000": Virtual vX3 LED "0000": Virtual vX4	0000 (0000~1111)	
F06.66 (0x0642) RUN	Virtual vY1 output selection	V/F SVC FVC PMVF PMSVC PMFVC See the functions of terminal Y.	0 (0~63)	
F06.67 (0x0643) RUN	Virtual vY2 output selection	V/F SVC FVC PMVF PMSVC PMFVC See the functions of terminal Y.	0 (0~63)	
F06.68 (0x0644) RUN	Virtual vY3 output selection	V/F SVC FVC PMVF PMSVC PMFVC See the functions of terminal Y.	0 (0~63)	
F06.69 (0x0645) RUN	Virtual vY4 output selection	V/F SVC FVC PMVF PMSVC PMFVC See the functions of terminal Y.	0 (0~63)	
F06.70 (0x0646) RUN	Delay when vY1 outputs ON	V/F SVC FVC PMVF PMSVC PMFVC Set the ON delay for vY1 output.	0.010s (0.000s~60.000s)	
F06.71 (0x0647) RUN	Delay when vY2 outputs ON	V/F SVC FVC PMVF PMSVC PMFVC Set the ON delay for vY2 output.	0.010s (0.000s~60.000s)	
F06.72 (0x0648) RUN	Delay when vY3 outputs ON	V/F SVC FVC PMVF PMSVC PMFVC Set the ON delay for vY3 output.	0.010s (0.000s~	

RUN			60.000s)	
F06.73 (0x0649) RUN	Delay when vY4 outputs ON	V/F SVC FVC PMVF PMSVC PMFVC Set the ON delay for vY4 output.	0.010s (0.000s~ 60.000s)	
F06.74 (0x064A) RUN	Delay when vY1 outputs OFF	V/F SVC FVC PMVF PMSVC PMFVC Set the OFF delay for vY1 output.	0.010s (0.000s~ 60.000s)	
F06.75 (0x064B) RUN	Delay when vY2 outputs OFF	V/F SVC FVC PMVF PMSVC PMFVC Set the OFF delay for vY2 output.	0.010s (0.000s~ 60.000s)	
F06.76 (0x064C) RUN	Delay when vY3 outputs OFF	V/F SVC FVC PMVF PMSVC PMFVC Set the OFF delay for vY3 output.	0.010s (0.000s~ 60.000s)	
F06.77 (0x064D) RUN	Delay when vY4 outputs OFF	V/F SVC FVC PMVF PMSVC PMFVC Set the OFF delay for vY4 output.	0.010s (0.000s~ 60.000s)	

10.11 Group F07: Running Control

Group F07.0x: Start Control

Parameter Code (Address)	Name	Description	Default (Range)	Reference Source
F07.00 (0x0700) STOP	Start mode	V/F SVC FVC PMVF PMSVC PMFVC 0: Start from start frequency 1: Apply DC brake first and then start from the Start frequency 2: Start after speed tracking and direction judgment	0 (0~2)	F07.0x
F07.01 (0x0701) STOP	Start pre- excitation time	V/F SVC FVC PMVF PMSVC PMFVC The vector control of asynchronous motor supports pre-excitation, which is not supported in other cases; When it is set as 0, the start pre-excitation time is determined by the motor parameters; When it is set as a non-0 value, the start pre- excitation time is the setting value.	0.00s (0.00s~60.00s)	
F07.02 (0x0702) STOP	Start frequency	V/F SVC FVC PMVF PMSVC PMFVC The drive does not start and stays in standby state when the given frequency is lower than this value.	0.50 Hz (0.00 - upper frequency limit set by numbers)	
F07.03 (0x0703) STOP	Start protection selection	V/F SVC FVC PMVF PMSVC PMFVC 0: OFF 1: ON LED "0": Terminal start protection in case of abnormal exit LED "00": Jogging terminal start protection in case of abnormal exit LED "000": Terminal start protection when the command channel is switched to terminal LED "0000": Reserved Note: The terminal start protection is enabled by default when the free stop, emergency stop or forced stop command is activated.	0111 (0000~0111)	
F07.05 (0x0705) STOP	Rotation direction selection	V/F SVC FVC PMVF PMSVC PMFVC LED "0": Reverse running direction 0: Direction unchanged	0000 (0000~1121)	

		<p>1: Reverse direction LED "00": Running direction disabled</p> <p>0: Both forward and reserve commands are allowed</p> <p>1: Only forward command is allowed</p> <p>2: Only reverse command is allowed</p> <p>LED "000": Command direction is controlled by frequency</p> <p>0: Frequency-based direction control is deactivated</p> <p>1: Frequency-based direction control is activated</p> <p>LED "0000": Reserved</p> <p>Note: This value will not be reset during initialization, and the LED "0" value will not be changed after parameter download</p>		
F07.06 (0x0706) STOP	Selection of restart action after power failure	<p>V/F SVC FVC PMVF PMSVC PMFVC</p> <p>0: Deactivated</p> <p>1: Speed tracking Start</p> <p>2: Start according to the Start mode</p>	0 (0~2)	
F07.07 (0x0707) STOP	Waiting time for restart after power failure	<p>V/F SVC FVC PMVF PMSVC PMFVC</p> <p>Set the waiting time for restart after power failure.</p>	0.50s (0.00s~60.00s)	

Group F07.1x: Stop and Zero-Frequency Control

Parameter Code (Address)	Name	Description	Default (Range)	Reference Source
F07.10 (0x070A) RUN	Stop mode	<p>V/F SVC FVC PMVF PMSVC PMFVC</p> <p>0: Deceleration stop</p> <p>1: Free stop (All stop commands are processed as free stop)</p>	0 (0~1)	F07.1x
F07.11 (0x070B) RUN	Stop detection frequency	<p>V/F SVC FVC PMVF PMSVC PMFVC</p> <p>When decelerating to stop, the drive will stop if the output frequency is lower than this value.</p>	0.50 Hz (0.00 - upper frequency limit digital setting)	
F07.12 (0x070C) STOP	Minimum time between stop and restart	<p>V/F SVC FVC PMVF PMSVC PMFVC</p> <p>The minimum interval between stop and restart.</p>	0.000s (0.000s~60.000s)	
F07.15 (0x070F) RUN	Selection of action below lower limit frequency	<p>V/F SVC FVC PMVF PMSVC PMFVC</p> <p>0: Run according to the frequency command</p> <p>1: Free stop and enter standby state</p> <p>2: Run at the lower limit frequency</p> <p>3: Run at zero speed</p>	2 (0~3)	
F07.16 (0x0710) RUN	Zero-speed torque retention coefficient	<p>SVC FVC PMVF PMSVC PMFVC</p> <p>Set the zero-speed torque current. 100.0% corresponds to the motor rated current, and the upper limit of the zero-speed torque current is the rated current of the drive.</p>	60.0% (0.0%~150.0%)	
F07.17 (0x0711) RUN	Zero-speed torque retention time	<p>SVC FVC PMVF PMSVC PMFVC</p> <p>Set the zero-speed torque retention time.</p>	0.0s (0.0s~6000.0s)	
F07.18 (0x0712) STOP	Forward and reverse rotation dead time	<p>V/F SVC FVC PMVF PMSVC PMFVC</p> <p>Set the zero-frequency retention time in the case of switching between forward and reverse rotations.</p>	0.0s (0.0s~120.0s)	

Group F07.2x: DC Braking and Speed Tracking

Parameter Code (Address)	Name	Description	Default (Range)	Reference Source
F07.20 (0x0714) STOP	Brake current before start	V/F SVC FVC PMVF PMSVC PMFVC 100.0% corresponds to the motor rated current, and the upper limit of brake current is the rated current of the drive.	60.0% (0.0%~150.0%)	F07.2x
F07.21 (0x0715) STOP	Brake time before start	V/F SVC FVC PMVF PMSVC PMFVC Set the brake time before start.	0.0s (0.0s~60.0s)	
F07.22 (0x0716) STOP	DC braking start frequency	V/F SVC FVC PMVF PMSVC PMFVC Set the DC braking start frequency.	1.00Hz (0.00Hz~50.00Hz)	
F07.23 (0x0717) STOP	DC brake current	V/F SVC FVC PMVF PMSVC PMFVC 100.0% corresponds to the motor rated current, and the upper limit of brake current is the rated current of the drive.	60.0% (0.0%~150.0%)	
F07.24 (0x0718) STOP	DC braking time during stop	V/F SVC FVC PMVF PMSVC PMFVC DC braking time during stop.	0.0s (0.0s~60.0s)	
F07.25 (0x0719) STOP	Speed tracking mode	V/F SVC FVC PMVF PMSVC PMFVC LED "0": Search mode 0: Search from maximum frequency 1: Search from stop frequency LED "00": Reverse search 0: OFF 1: ON LED "000": Reserved LED "0000": Reserved	0000 (0000~0111)	
F07.26 (0x071A) STOP	Speed tracking time	V/F SVC FVC PMVF PMSVC PMFVC Speed tracking time.	0.50s (0.00s~60.00s)	
F07.27 (0x071B) STOP	Speed tracking stop delay	V/F SVC FVC PMVF PMSVC PMFVC Speed tracking stop delay.	1.00s (0.00s~60.00s)	
F07.28 (0x071C) STOP	Speed tracking current	V/F SVC FVC PMVF PMSVC PMFVC Set the speed tracking current.	120.0% (0.0%~400.0%)	

Group F07.3x: Jogging

Parameter Code (Address)	Name	Description	Default (Range)	Reference Source
F07.30 (0x071E) RUN	Jogging frequency setting	V/F SVC FVC PMVF PMSVC PMFVC Set the jogging frequency.	5.00 Hz (0.00 Hz - maximum frequency)	F07.3x
F07.31 (0x071F) RUN	Jogging acceleration time	V/F SVC FVC PMVF PMSVC PMFVC Set the jogging acceleration time.	10.00s (0.00s~650.00s)	
F07.32 (0x0720) RUN	Jogging deceleration time	V/F SVC FVC PMVF PMSVC PMFVC Set the jogging deceleration time.	10.00s (0.00s~650.00s)	

F07.33 (0x0721) RUN	Jogging S-curve selection	V/F SVC FVC PMVF PMSVC PMFVC 0: Deactivated 1: Activated	1 (0~1)	
F07.34 (0x0722) RUN	Jogging stop mode selection	V/F SVC FVC PMVF PMSVC PMFVC 0: The same as the stop mode set by F7.10. 1: Deceleration stop only.	0 (0~1)	

Group F07.4x: Start and Stop Frequency Retention and Frequency Hopping

Parameter Code (Address)	Name	Description	Default (Range)	Reference Source
F07.40 (0x0728) STOP	Start retention frequency	V/F SVC FVC PMVF PMSVC PMFVC The Start retention frequency is higher than the Start frequency and lower than the upper frequency limit set by numbers.	0.50 Hz (0.00 Hz - upper frequency limit set by numbers)	F07.4x
F07.41 (0x0729) STOP	Start frequency retention time	V/F SVC FVC PMVF PMSVC PMFVC The set point should be greater than the Start frequency, and if not, the Start frequency will be used.	0.00s (0.00s~60.00s)	
F07.42 (0x072A) STOP	Stop retention frequency	V/F SVC FVC PMVF PMSVC PMFVC Set the retention frequency during stop.	0.50 Hz (0.00 - upper frequency limit set by numbers)	
F07.43 (0x072B) STOP	Stop frequency retention time	V/F SVC FVC PMVF PMSVC PMFVC Set the frequency retention time during stop.	0.00s (0.00s~60.00s)	
F07.44 (0x072C) RUN	Jumping frequency 1	V/F SVC FVC PMVF PMSVC PMFVC Set the jumping frequency 1.	0.00 Hz (0.00 - maximum frequency)	
F07.45 (0x072D) RUN	Jumping frequency amplitude 1	V/F SVC FVC PMVF PMSVC PMFVC Set the jumping frequency amplitude 1.	0.00 Hz (0.00 - maximum frequency)	
F07.46 (0x072E) RUN	Jumping frequency 2	V/F SVC FVC PMVF PMSVC PMFVC Set the jumping frequency 2.	0.00 Hz (0.00 - maximum frequency)	
F07.47 (0x072F) RUN	Jumping frequency amplitude 2	V/F SVC FVC PMVF PMSVC PMFVC Set the jumping frequency amplitude 1.	0.00 Hz (0.00 - maximum frequency)	

10.12 Group F08: Auxiliary Control

Group F08.0x: Counting and Timing

Parameter Code (Address)	Name	Description	Default (Range)	Reference Source
F08.00 (0x0800) RUN	Counter input source	V/F SVC FVC PMVF PMSVC PMFVC 0: Normal terminal X 1: Input terminal PUL 2: PG card feedback counting	0 (0~2)	F08.0x
F08.01 (0x0801) RUN	Count input frequency division	V/F SVC FVC PMVF PMSVC PMFVC Set the count input frequency division.	0 (0~6000)	
F08.02	Counter	V/F SVC FVC PMVF PMSVC PMFVC	1000	

(0x0802) RUN	maximum value	Set the counter maximum value.	(0~65000)	
F08.03 (0x0803) RUN	Counter setting value	V/F SVC FVC PMVF PMSVC PMFVC Set the counter setting value.	500 (0~65000)	
F08.04 (0x0804) RUN	Number of pulses per meter	V/F SVC FVC PMVF PMSVC PMFVC The counting value per meter.	10.0 (0.1~6553.5)	
F08.05 (0x0805) STOP	Set length	V/F SVC FVC PMVF PMSVC PMFVC Add a length reaching output, and a terminal length reset.	1000 (0m~65535m)	
F08.06 (0x0806) STOP	Actual length	V/F SVC FVC PMVF PMSVC PMFVC Reset during power-off. Chooses whether to store during power-off.	0 (0m~65535m)	
F08.07 (0x0807) STOP	Timer time unit	V/F SVC FVC PMVF PMSVC PMFVC 0: Second (s) 1: Minute (min) 2: Hour (h)	0 (0~2)	
F08.08 (0x0808) STOP	Timer setting value	V/F SVC FVC PMVF PMSVC PMFVC Set the timer setting value.	0 (0~65000)	

Group F08.3x: Swing Frequency Control

Parameter Code (Address)	Name	Description	Default (Range)	Reference Source
F08.30 (0x081E) STOP	Swing frequency control	V/F SVC FVC PMVF PMSVC PMFVC 0: Swing frequency control is deactivated. 1: Swing frequency control is activated.	0 (0~1)	F08.3x
F08.31 (0x081F) STOP	Swing frequency amplitude control	V/F SVC FVC PMVF PMSVC PMFVC LED "0" : Start mode 0: Automatic 1: Manual with terminal LED "00": Swing frequency amplitude control 0: Relative to center frequency 1: Relative to maximum frequency LED"000": Swing frequency state: 0: Store during stop 1: Not store during stop LED "0000": Storage of swing frequency state during power-off 0: Store 1: Not store	0000 (0000~0111)	
F08.32 (0x0820) STOP	Preset swing frequency	V/F SVC FVC PMVF PMSVC PMFVC Set the preset swing frequency.	0.00 Hz (0.00 - maximum frequency)	
F08.33 (0x0821) STOP	Preset swing frequency waiting time	V/F SVC FVC PMVF PMSVC PMFVC Set the preset swing frequency waiting time.	0.0s (0.0s~3600.0s)	
F08.34 (0x0822) STOP	Swing frequency amplitude	V/F SVC FVC PMVF PMSVC PMFVC Set the swing frequency amplitude.	10.0% (0.0%~50.0%)	
F08.35 (0x0823) STOP	Jump frequency	V/F SVC FVC PMVF PMSVC PMFVC Set the jump frequency.	10.0Hz (0.0Hz~50.0Hz)	

F08.36 (0x0824) STOP	Triangular wave rise time	V/F SVC FVC PMVF PMSVC PMFVC Set the rise time of triangular wave.	5.00s (0.1s~ 650.00s)	
F08.37 (0x0825) STOP	Triangular wave drop time	V/F SVC FVC PMVF PMSVC PMFVC Set the drop time of triangular wave.	5.00s (0.005s~ 650.00s)	

10.13 Group F09: Auxiliary Control 2

Group F09.0x: Maintenance Functions

Parameter Code (Address)	Name	Description	Default (Range)	Reference Source
F09.02 (0x0902) RUN	Device maintenance alarm selection	V/F SVC FVC PMVF PMSVC PMFVC LED "0": Cooling fan 0: Deactivated 1: Activated LED "00": Main relay 0: Deactivated 1: Activated LED "000": Reserved LED "0000": Reserved	0000 (0000~1111)	F09.0x
F09.03 (0x0903) STOP	Cooling fan maintenance setting	V/F SVC FVC PMVF PMSVC PMFVC Set in hours. Set to 0 when replacing the cooling fan with a new one.	0 (0~65535)	
F09.04 (0x0904) STOP	Main relay maintenance setting	V/F SVC FVC PMVF PMSVC PMFVC Set to 0.0% when replacing the main relay with a new one.	0.0% (0.0%~ 150.0%)	

10.14 Group F10: Protection Parameters

Group F10.0x: Current Protection

Parameter Code (Address)	Name	Description	Default (Range)	Reference Source
F10.00 (0x0A00) RUN	Overcurrent suppression function	V/F SVC FVC PMVF PMSVC PMFVC Automatically limit the output current to the set overcurrent suppression point to prevent overcurrent fault. 0: Suppression is always activated. 1: Activated during acceleration/deceleration, deactivated at constant speed.	0 (0~1)	F10.0x
F10.01 (0x0A01) RUN	Overcurrent suppression point	V/F SVC FVC PMVF PMSVC PMFVC Set the load current limiting level. 100% corresponds to the rated current of the drive.	160.0% (0.0%~ 300.0%)	
F10.02 (0x0A02) RUN	Overcurrent suppression gain	V/F SVC FVC PMVF PMSVC PMFVC Set the response effect of overcurrent suppression.	100.0% (0.0%~ 500.0%)	
F10.03 (0x0A03) STOP	Current protection setting 1	V/F SVC FVC PMVF PMSVC PMFVC Set whether the current-related protection function is enabled. LED "0": Cycle-by-cycle current limiting (CBC) 0: OFF 1: ON LED "00": OC protection interference suppression 0: Normal 1: First degree interference suppression 2: Second degree interference suppression LED "000": SC protection interference suppression 0: Normal 1: First degree interference suppression	0001 (0000~f221)	

		2: Second degree interference suppression LED "0000": Reserved		
F10.04 (0x0A04) STOP	Current protection setting 2	V/F SVC FVC PMVF PMSVC PMFVC LED "0": Three-phase current and protection selection 0: OFF 1: ON LED "00": Three-phase current imbalance protection selection 0: OFF 1: ON	0001 (0000~0011)	
F10.05 (0x0A05) STOP	Current imbalance judgment threshold	V/F SVC FVC PMVF PMSVC PMFVC Compare the ratio of the maximum phase to the minimum phase in the three-phase current with this set point to judge whether the current imbalance occurs.	160% (0%~500%)	
F10.06 (0x0A06) STOP	Current imbalance filter coefficient	V/F SVC FVC PMVF PMSVC PMFVC The parameter value should be increased at a site with strong current fluctuation.	2.0s (0.0s~60.0s)	

Group F10.1x: Voltage Protection

Parameter Code (Address)	Name	Description	Default (Range)	Reference Source
F10.11 (0x0A0B) STOP	Bus overvoltage suppression function	V/F SVC FVC PMVF PMSVC PMFVC Slow down or stop acceleration or deceleration to prevent overvoltage fault when the bus voltage is higher than the overvoltage suppression point. LED "0": overvoltage suppression function 0: OFF 1: ON LED "00": over-excitation function 0: OFF 1: Activated only during deceleration 2: Activated during running	0011 (0000~0021)	F10.1x
F10.12 (0x0A0C) STOP	Bus overvoltage suppression point	V/F SVC FVC PMVF PMSVC PMFVC Set the bus voltage value that triggers the overvoltage suppression function.	T3: 750 V S2: 370 V (0 V - overvoltage point) T3 overvoltage point: 820 V S2 overvoltage point: 400 V	
F10.13 (0x0A0D) RUN	Bus overvoltage suppression gain	V/F SVC FVC PMVF PMSVC PMFVC Set the response effect of overvoltage suppression.	100.0% (0.0%~500.0%)	
F10.14 (0x0A0E) RUN	Dynamic brake enabling	V/F SVC FVC PMVF PMSVC PMFVC Set whether the dynamic brake function is enabled. 0: OFF 1: Enabled with overvoltage suppression disabled 2: Enabled with overvoltage suppression enabled	2 (0~2)	
F10.15 (0x0A0F) RUN	Dynamic brake action voltage	V/F SVC FVC PMVF PMSVC PMFVC Set the dynamic brake action voltage. The dynamic brake works when the bus voltage is higher than this value.	T3: 740 V S2: 360 V (0 V - overvoltage point) T3 overvoltage point: 820 V S2 overvoltage	

			point: 400 V	
F10.16 (0x0A10) STOP	Bus undervoltage suppression function	V/F SVC FVC PMVF PMSVC PMFVC Limit the bus voltage decrease when the bus voltage is lower than the undervoltage suppression point by automatically adjusting the operating frequency to prevent undervoltage fault. 0: OFF 1: ON	0 (0~1)	
F10.17 (0x0A11) STOP	Bus undervoltage suppression point	V/F SVC FVC PMVF PMSVC PMFVC Set the bus voltage value that triggers the undervoltage suppression function.	T3: 430 V S2: 240 V (0 V - overvoltage point) T3 overvoltage point: 820 V S2 overvoltage point: 400 V	
F10.18 (0x0A12) RUN	Bus undervoltage suppression gain	V/F SVC FVC PMVF PMSVC PMFVC Set the response effect of undervoltage suppression.	100.0% (0.0%~500.0%)	
F10.19 (0x0A13) STOP	Bus undervoltage protection point	V/F SVC FVC PMVF PMSVC PMFVC Set the allowable lower limit of bus voltage. The drive will report the undervoltage fault when the bus voltage is lower than this value.	T3: 320 V S2: 190 V (0 V - overvoltage point) T3 overvoltage point: 820 V S2 overvoltage point: 400 V	

Group F10.2x: Auxiliary Protection

Parameter Code (Address)	Name	Description	Default (Range)	Reference Source
F10.20 (0x0A14) STOP	Input and output phase loss protection selection	V/F SVC FVC PMVF PMSVC PMFVC Set whether the input and output phase loss protection function is enabled. LED "0": Output phase loss protection function 0: OFF 1: ON LED "00": Input phase loss protection function 0: OFF 1: ON. The drive reports alarm A. iLF and keeps running when input phase loss is detected. 2: ON. The drive reports error E. iLF and free stops when input phase loss is detected. LED "000": Reserved LED "0000": Reserved	0021 (0000~1121)	F10.2x
F10.21 (0x0A15) STOP	Input phase loss threshold	V/F SVC FVC PMVF PMSVC PMFVC Set the voltage detection percentage for the input phase loss detection function. 100% corresponds to the rated bus voltage.	10.0% (0.0%~30.0%)	
F10.22 (0x0A16) STOP	Grounding short circuit protection selection	V/F SVC FVC PMVF PMSVC PMFVC Set whether the ground short circuit protection function for the drive output and cooling fan is enabled. LED "0": Output short-to-ground protection function 0: OFF 1: Detection upon power-on 2: pre-	0111 (0000~0112)	

		running detection LED "00": Fan short-to-ground protection function 0: OFF 1: ON LED "000": Power short-to-ground protection function 0: OFF 1: ON		
F10.23 (0x0A17) RUN	Fan ON/OFF control selection	V/F SVC FVC PMVF PMSVC PMFVC Set the running mode of the drive's cooling fan. 0: The fan works after the drive is powered on. 1: After the drive stops, the fan runs according to the temperature, and the fan runs when the drive is running. 2: After the drive stop, the fan stops after the time set by F10.24, and runs according to the temperature.	1 (0~2)	
F10.24 (0x0A18) STOP	Fan control delay	V/F SVC FVC PMVF PMSVC PMFVC Set the time from releasing the running command to stop of the cooling fan.	30.00s (0.00s~ 600.00s)	
F10.25 (0x0A19) RUN	Drive overheat oH1 warning detection level	V/F SVC FVC PMVF PMSVC PMFVC Set the temperature value for overheat warning of the drive. Overheat warning is activated if the temperature is higher than this value.	80.0°C (0.0°C~ 100.0°C)	
F10.26 (0x0A1A) RUN	Motor overheat protection selection (Extension card)	V/F SVC FVC PMVF PMSVC PMFVC Set the motor overheat protection when an IO extension card is used. LED "0": Motor temperature sensor type 0: PT1000 1: KTY84 F10.26 is activated when the DIP switch on the IO extension card is flipped to KTY; The PT100 sensor is activated when the DIP switch on the IO extension card is flipped to PT100.	0x01 (0x00~0x01)	
F10.27 (0x0A1B) RUN	Motor overheat alarm level (Extension card)	V/F SVC FVC PMVF PMSVC PMFVC Set the temperature value for overheat fault of the drive. Overheat fault is reported if the temperature is higher than this value.	110.0°C (0.0°C~ 200.0°C)	
F10.28 (0x0A1C) RUN	Motor overheat warning level (Extension card)	V/F SVC FVC PMVF PMSVC PMFVC Set the temperature value for overheat warning of the drive. Overheat warning is activated if the temperature is higher than this value.	90.0°C (0.0°C~ F10.27)	

Group F10.3x: Load Protection

Parameter Code (Address)	Name	Description	Default (Range)	Reference Source
F10.32 (0x0A20) STOP	Load warning detection setting	<p>V/F SVC FVC PMVF PMSVC PMFVC Set the load warning detection mode and the warning mode of the drive. LED "0": Load warning detection 1 setting 0: Do not detect 1: Detect overload 2: Detect overload only at constant speed 3: Detect underload 4: Detect underload only at constant speed LED "00": warning setting for load warning detection 1 0: Continue running and report A. Ld1 1: Free stop, and report E. Ld1 LED "000": Load warning detection 2 setting 0: Do not detect 1: Detect overload 2: Detect overload only at constant speed 3: Detect underload 4: Detect underload only at constant speed LED "0000": Warning setting for load warning detection 2 0: Continue running and report A. Ld2 1: Free stop, and report E. Ld2</p>	0000 (0000~1414)	
F10.33 (0x0A21) STOP	Load warning detection level 1	<p>V/F SVC FVC PMVF PMSVC PMFVC Set the detection value of load warning 1. In VF control, 100% corresponds to the rated current of the motor. In vector control, 100% corresponds to the rated output torque of the motor.</p>	130.0% (0.0%~200.0%)	
F10.34 (0x0A22) STOP	Load warning detection time 1	<p>V/F SVC FVC PMVF PMSVC PMFVC Set the duration of detecting load warning 1. The load warning 1 will be detected if the load is higher than the detection value and last for this time.</p>	5.0s (0.0s~60.0s)	
F10.35 (0x0A23) STOP	Load warning detection level 2	<p>V/F SVC FVC PMVF PMSVC PMFVC Set the detection value of load warning 2. In VF control, 100% corresponds to the rated current of the motor. In vector control, 100% corresponds to the rated output torque of the motor.</p>	30.0% (0.0%~200.0%)	
F10.36 (0x0A24) STOP	Load warning detection time 2	<p>V/F SVC FVC PMVF PMSVC PMFVC Set the duration of detecting load warning 2. The load warning 2 will be detected if the load is higher than the detection value and last for this time.</p>	5.0s (0.0s~60.0s)	

Group F10.4x: Stall Protection

Parameter Code (Address)	Name	Description	Default (Range)	Reference Source
F10.40 (0x0A28)	Excessive speed	<p>V/F SVC FVC PMVF PMSVC PMFVC Set the warning detection mode and alarm mode</p>	0000 (0000~0012)	F10.4x

STOP	deviation protection action	when the deviation between the set speed and feedback speed of the motor is excessive. LED "0": Detection selection 0: Do not detect 1: Detect only at constant speed 2: Always detect LED "00": Alarm selection 0: Free stop and report a fault 1: Send an alarm and keep running		
F10.41 (0x0A29) STOP	Excessive speed deviation detection threshold	V/F SVC FVC PMVF PMSVC PMFVC Set the value for detecting excessive speed deviation. The value of 100% corresponds to F01.10 [Maximum frequency].	10.0% (0.0%~60.0%)	
F10.42 (0x0A2A) STOP	Excessive speed deviation detection time	V/F SVC FVC PMVF PMSVC PMFVC Set the duration for detecting excessive speed deviation. If the deviation between the set speed and the feedback speed is greater than F10.41 and lasts for this time, the excessive speed deviation is detected and a warning is sent.	2.0s (0.0s~60.0s)	
F10.43 (0x0A2B) STOP	Overspeed protection action	V/F SVC FVC PMVF PMSVC PMFVC Set the warning detection mode and alarm mode in the case of motor overspeed. LED "0": Detection selection 0: Do not detect 1: Detect only at constant speed 2: Always detect LED "00": Alarm selection 0: Free stop and report a fault 1: Send an alarm and keep running	0002 (0000~0012)	
F10.44 (0x0A2C) STOP	Overspeed detection threshold	V/F SVC FVC PMVF PMSVC PMFVC Set the value for detecting overspeed. The value of 100% corresponds to F01.10 [Maximum frequency].	110.0% (0.0%~150.0%)	
F10.45 (0x0A2D) STOP	Overspeed detection time	V/F SVC FVC PMVF PMSVC PMFVC Set the duration for detecting overspeed. If the feedback speed is greater than F10.44 and lasts for this time, the overspeed is detected and a warning is sent.	0.100s (0.000s~2.000s)	

Group F10.5x: Fault Recovery and Motor Overload

Parameter Code (Address)	Name	Description	Default (Range)	Reference Source
F10.50 (0x0A32) STOP	Fault self-recovery times	V/F SVC FVC PMVF PMSVC PMFVC Set how many times fault self-recovery is allowed. Note: The value of 0 indicates that the fault self-recovery function is disabled, while any other value indicates that the function is enabled.	0 (0~10)	F10.5x
F10.51 (0x0A33) STOP	Fault self-recovery interval	V/F SVC FVC PMVF PMSVC PMFVC Set the waiting time between a fault and fault recovery of the drive.	1.0s (0.0s~100.0s)	
F10.52 (0x0A34) READ	Times of fault recovery	V/F SVC FVC PMVF PMSVC PMFVC Indicate how many times fault self-recovery has been performed. This parameter is read only.	0	

F10.55 (0x0A37) RUN	Motor overload model	V/F SVC FVC PMVF PMSVC PMFVC 0: Ordinary motor 1: Frequency conversion motor (50 Hz) 2: Frequency conversion motor (60 Hz) 3: Motor without cooling fan	0 (0~3)	
F10.56 (0x0A38) STOP	Motor insulation class	V/F SVC FVC PMVF PMSVC PMFVC 0: Insulation class A 1: Insulation class E 2: Insulation class B 3: Insulation class F 4: Insulation class H 5: Special class S	3 (0~5)	
F10.57 (0x0A39) STOP	Motor working system	V/F SVC FVC PMVF PMSVC PMFVC 0-1: S1 working system (continuous working) 2: S2 working system 3-9: Corresponding to S3-S9	0 (0~9)	
F10.58 (0x0A3A) STOP	Motor overload start threshold	V/F SVC FVC PMVF PMSVC PMFVC The starting threshold of motor overload. When the actual current is greater than this value, the overload increases on a cumulative basis.	105.0% (0.0%~130.0%)	
F10.59 (0x0A3B) STOP	Motor overload current coefficient	V/F SVC FVC PMVF PMSVC PMFVC Calculated motor overload current = actual current * motor overload current coefficient.	100.0% (0.0%~250.0%)	

10.15 Group F11: Keypad Parameters

Group F11.0x: Button Operation

Parameter Code (Address)	Name	Description	Default (Range)	Reference Source
F11.00 (0x0B00) RUN	Button lock selection	V/F SVC FVC PMVF PMSVC PMFVC 0: Not locked 1: Keypad function parameter modification is locked 2: Function parameters and non-start/stop buttons are locked 3: All function parameters and buttons are locked	0 (0~3)	F11.0x
F11.01 (0x0B01) RUN	Button lock password	V/F SVC FVC PMVF PMSVC PMFVC Used together with the button lock. Please remember the password after it is set, or you will not be able to operate the drive after locking.	0 (0~65535)	
F11.02 (0x0B02) STOP	Keypad multi-function button selection	V/F SVC FVC PMVF PMSVC PMFVC 0: Deactivated 1: Reverse running button 2: Forward jogging button 3: Reverse jogging button 4: Switching between the keypad command channel and the terminal command channel 5: Switching between the keypad command channel and the communication command channel 6: Switching between the terminal command channel and the communication command channel 7: Switching between keypad, terminal and communication command channels	0 (0~7)	

F11.03 (0x0B03) STOP	Keypad STOP button setting	V/F SVC FVC PMVF PMSVC PMFVC 0: Non-keypad control mode is disabled 1: Non-keypad control mode stops according to the stopping mode 2: Non-keypad control mode free stop	0 (0~2)	
F11.04 (0x0B04) STOP	Function of Up/Down button (Knob) in status interface	V/F SVC FVC PMVF PMSVC PMFVC LED "0": Keypad up/down button used for modification 0: Deactivated 1: Adjust F01.09 frequency digital given 2: Adjust F13.01 PID digital given 3: Adjust the function code corresponding to F11.05 setting LED "00": Storage after power-off 0: Frequency is not stored after power-off 1: Frequency is stored after power-off LED "000": Action limit 0: Adjustable during running and stop 1: Adjustable only during running, and maintained during stop 2: Adjustable during running; reset during stop LED "0000": Reserved	0011 (0000~0213)	
F11.05 (0x0B05) RUN	Parameter code setting quick change with Up/Down button	V/F SVC FVC PMVF PMSVC PMFVC LED "0" and LED "00": Set yy in function parameter number Fxx.yy 00-99 LED "000" and LED "0000": Set xx in function parameter number Fxx.yy 00-29 F11.04 is effective when the LED "0" is 3. For example, when F11.05 = xxyy, the up and down buttons of the keypad can be used to modify the setting of [Fxx.yy] quickly	0109 (0000~2999)	
F11.06 (0x0B06) STOP	Keypad command button selection	V/F SVC FVC PMVF PMSVC PMFVC LED "0": Internal and external keypad button commands (Run command, and stop/reset commands) 0: External commands takes precedence. When external commands are effective, internal ones are ineffective 1: Internal commands takes precedence. When internal commands are effective, external ones are ineffective 2: Both internal and external commands are effective, and the stop/reset command takes precedence LED "00": Reserved LED "000": Reserved LED "0000": Reserved	0000 (0000~2122)	

Group F11.1x: Status Interface Cyclic Monitoring

Parameter Code (Address)	Name	Description	Default (Range)	Reference Source
F11.10	Function of Left/Right Keys	V/F SVC FVC PMVF PMSVC PMFVC LED "0": The left key is used to adjust the first line	0011	F11.1x

(0x0B0A) STOP	in Status Interface	of monitoring 0: Deactivated 1: Activated LED "00": The left right is used to adjust the second line of monitoring 0: Deactivated 1: Activated When the left/right key is disabled, the monitoring display value is parameter 1 after powering on again.	(0000~0011)	
F11.11 (0x0B0B) RUN	The cyclic display parameter 1 in the first line of the keypad	V/F SVC FVC PMVF PMSVC PMFVC LED "0" and LED "00": Set yy in monitoring parameter number Cxx.yy 00-63 LED "000" and LED "0000": Set xx in monitoring parameter number Cxx.yy 00-07	0000 (0000~0763)	
F11.12 (0x0B0C) RUN	The cyclic display parameter 2 in the first line of the keypad	V/F SVC FVC PMVF PMSVC PMFVC LED "0" and LED "00": Set yy in monitoring parameter number Cxx.yy 00-63 LED "000" and LED "0000": Set xx in monitoring parameter number Cxx.yy 00-07	0001 (0000~0763)	
F11.13 (0x0B0D) RUN	The cyclic display parameter 3 in the first line of the keypad	V/F SVC FVC PMVF PMSVC PMFVC LED "0" and LED "00": Set yy in monitoring parameter number Cxx.yy 00-63 LED "000" and LED "0000": Set xx in monitoring parameter number Cxx.yy 00-07	0002 (0000~0763)	
F11.14 (0x0B0E) RUN	The cyclic display parameter 4 in the first line of the keypad	V/F SVC FVC PMVF PMSVC PMFVC LED "0" and LED "00": Set yy in monitoring parameter number Cxx.yy 00-63 LED "000" and LED "0000": Set xx in monitoring parameter number Cxx.yy 00-07	0011 (0000~0763)	
F11.15 (0x0B0F) RUN	The cyclic display parameter 1 in the second line of the keypad	V/F SVC FVC PMVF PMSVC PMFVC LED "0" and LED "00": Set yy in monitoring parameter number Cxx.yy 00-63 LED "000" and LED "0000": Set xx in monitoring parameter number Cxx.yy 00-07	0002 (0000~0763)	
F11.16 (0x0B10) RUN	The cyclic display parameter 2 in the second line of the keypad	V/F SVC FVC PMVF PMSVC PMFVC LED "0" and LED "00": Set yy in monitoring parameter number Cxx.yy 00-63 LED "000" and LED "0000": Set xx in monitoring parameter number Cxx.yy 00-07	0004 (0000~0763)	
F11.17 (0x0B11) RUN	The cyclic display parameter 3 in the second line of the keypad	V/F SVC FVC PMVF PMSVC PMFVC LED "0" and LED "00": Set yy in monitoring parameter number Cxx.yy 00-63 LED "000" and LED "0000": Set xx in monitoring parameter number Cxx.yy	0010 (0000~0763)	

		00-07		
F11.18 (0x0B12) RUN	The cyclic display parameter 4 in the second line of the keypad	V/F SVC FVC PMVF PMSVC PMFVC LED "0" and LED "00": Set yy in monitoring parameter number Cxx.yy 00-63 LED "000" and LED "0000": Set xx in monitoring parameter number Cxx.yy 00-07	0012 (0000~0763)	

Group F11.2x: Monitoring Parameter Control

Parameter Code (Address)	Name	Description	Default (Range)	Reference Source
F11.20 (0x0B14) RUN	Keypad display setting 1	V/F SVC FVC PMVF PMSVC PMFVC LED "0": Output frequency display selection 0: Target Frequency 1: Running Frequency 2-F: Running frequency filtering. The larger the value, the better the filtering LED "00": Reserved LED "000": Power display dimension 0: Power display in percentage (%) 1: Power display in kilowatt (kW) LED "0000": Reserved	0002 (0000~111F)	F11.2x
F11.21 (0x0B15) RUN	Speed display coefficient	V/F SVC FVC PMVF PMSVC PMFVC Adjust the display of C00.05 speed.	100.0% (0.0%~500.0%)	
F11.22 (0x0B16) RUN	Power display coefficient	V/F SVC FVC PMVF PMSVC PMFVC Adjust the display of C00.10 output power.	100.0% (0.0%~500.0%)	
F11.23 (0x0B17) RUN	Monitoring parameter group display selection	V/F SVC FVC PMVF PMSVC PMFVC LED "0": Monitoring parameter mapping 0: AC310 1: AC70 LED "00": Group C05 display selection 0: Automatically switch according to the control mode 1: Parameters related to VF mode 2: Parameters related to VC mode LED "000": C00.40 - C00.63 display selection 0: Not display 1: Display LED "0000": Communication fault code switching 0: Communication fault code table 1 (AC310) 1: Communication fault code table 2 (AC70) 2: Communication fault code table 3 (AC300)	0000 (0000~FFFF)	
F11.24 (0x0B18) RUN	Monitoring parameter filtering selection	V/F SVC FVC PMVF PMSVC PMFVC LED "0": Output current display filtering 0-F: The larger the value, the better the filtering LED "00": Reserved LED "000": Reserved LED "0000": Reserved	0002 (0000~000F)	
F11.25 (0x0B19) STOP	Display during motor Auto-tuning	V/F SVC FVC PMVF PMSVC PMFVC 0: Show the status of Auto-tuning process 1: Not show the status of Auto-tuning process	0 (0~1)	
F11.27	Fault self-	V/F SVC FVC PMVF PMSVC PMFVC	0001	

(0x0B1B) RUN	recovery display selection	LED "0": Display the fault during fault self-recovery 0: Not display 1: Display	(0000~0001)	
-----------------	----------------------------	---	-------------	--

Group F11.3x: Special Keypad Functions

Parameter Code (Address)	Name	Description	Default (Range)	Reference Source
F11.31 (0x0B1F) RUN	Lower limit voltage of keypad potentiometer	V/F SVC FVC PMVF PMSVC PMFVC Set the lower voltage limit of keypad potentiometer (the optional external single-line keypad is activated).	0.50V (0.00V~3.00V)	F11.3x
F11.32 (0x0B20) RUN	Corresponding value to lower limit of keypad potentiometer	V/F SVC FVC PMVF PMSVC PMFVC Set the corresponding value to the lower limit of keypad potentiometer (the optional external single-line keypad is activated).	0.00% (0.00%~100.00%)	
F11.33 (0x0B21) RUN	Upper limit voltage of keypad potentiometer	V/F SVC FVC PMVF PMSVC PMFVC Set the upper voltage limit of keypad potentiometer (the optional external single-line keypad is activated).	2.80V (0.00V~3.00V)	
F11.34 (0x0B22) RUN	Corresponding value to upper limit of keypad potentiometer	V/F SVC FVC PMVF PMSVC PMFVC Set the corresponding value to the upper limit of keypad potentiometer (the optional external single-line keypad is activated).	100.0% (0.00%~100.00%)	
F11.35 (0x0B23) STOP	Keypad potentiometer selection	V/F SVC FVC PMVF PMSVC PMFVC Set the keypad potentiometer channel. 0: Reserved 1: External keypad potentiometer	1 (0~1)	

10.16 Group F12: Communication Parameters

Group F12.0x: Modbus Communication Slave Parameters

Parameter Code (Address)	Name	Description	Default (Range)	Reference Source
F12.00 (0x0C00) STOP	Master/Slave selection	V/F SVC FVC PMVF PMSVC PMFVC 0: Slave 1: Master	0 (0~1)	F12.0x
F12.01 (0x0C01) STOP	Modbus communication address	V/F SVC FVC PMVF PMSVC PMFVC Set different values for different slave stations.	1 (1~247)	
F12.02 (0x0C02) STOP	Communication baud rate selection	V/F SVC FVC PMVF PMSVC PMFVC 0: 1,200 bps 1: 2,400 bps 2: 4,800 bps 3: 9,600 bps 4: 19,200 bps 5: 38,400 bps 6: 57,600 bps	3 (0~6)	
F12.03 (0x0C03) STOP	Modbus communication data format	V/F SVC FVC PMVF PMSVC PMFVC 0: (N, 8, 1) No check, data bits: 8, stop bits: 1 1: (E, 8, 1) Even parity check, data bits: 8, stop bits: 1 2: (O, 8, 1) Odd parity check, data bits: 8, stop bits: 1 3: (N, 8, 2) No check, data bits: 8, stop bits: 2	0 (0~5)	

		4: (E, 8, 2) Even parity check, data bits: 8, stop bits: 2 5: (O, 8, 2) Odd parity check, data bits: 8, stop bits: 2		
F12.04 (0x0C04) RUN	Modbus communication transmission response processing	V/F SVC FVC PMVF PMSVC PMFVC 0: Write with response 1: Write without response	0 (0~1)	
F12.05 (0x0C05) RUN	Modbus communication response delay	V/F SVC FVC PMVF PMSVC PMFVC Set the response delay of modbus communication.	0ms (0ms~5000ms)	
F12.06 (0x0C06) RUN	Modbus communication timeout fault time	V/F SVC FVC PMVF PMSVC PMFVC Set the timeout fault time of modbus communication timeout failure time.	1.0s (0.1s~100.0s)	
F12.07 (0x0C07) RUN	Communication disconnection processing	V/F SVC FVC PMVF PMSVC PMFVC 0: Do not detect timeout fault 1: Alarm and free Stop 2: Warning and keep running 3: Forced stop	0 (0~3)	
F12.08 (0x0C08) RUN	Receiving data (Address 0x3000) zero bias	V/F SVC FVC PMVF PMSVC PMFVC Conduct offset correction for the communication data of address 0x3000.	0.00 (-100.00~100.00)	
F12.09 (0x0C09) RUN	Receive data (Address 0x3000) gain	V/F SVC FVC PMVF PMSVC PMFVC Conduct linear correction for the communication data of address 0x3000.	100.0% (0.0%~500.0%)	

Group F12.1x: Modbus Master Parameters

Parameter Code (Address)	Name	Description	Default (Range)	Reference Source
F12.10 (0x0C0A) RUN	Master Loop Transmission Parameter Selection	V/F SVC FVC PMVF PMSVC PMFVC LED "0", LED "00", LED "000", LED "0000" 0: Invalid 1: Master run command 2: Master given frequency 3: Master output frequency 4: Master upper limit frequency 5: Master given torque 6: Master output torque 7: Reserved 8: Reserved 9: Master PID setting A: Master PID Feedback B: Reserved C: Active current component	0031 (0000~CCCC)	F12.1x
F12.11 (0x0C0B) RUN	Custom Address Of Given Frequency	V/F SVC FVC PMVF PMSVC PMFVC Defines given frequency address, compatible with upper computer (PLC) instructions.	0000 (0000~FFFF)	
F12.12 (0x0C0C) RUN	Command Setting Custom Address	V/F SVC FVC PMVF PMSVC PMFVC Defines command setting address, compatible with upper computer (PLC) instructions.	0000 (0000~FFFF)	

	Setting			
F12.13 (0x0C0D) RUN	Custom Address Of Forward Running Command	V/F SVC FVC PMVF PMSVC PMFVC Defines the address of forward running command	0001 (0000~FFFF)	
F12.14 (0x0C0E) RUN	Custom Address Of Reverse Running Command	V/F SVC FVC PMVF PMSVC PMFVC Defines the address of reverse running command	0002 (0000~FFFF)	
F12.15 (0x0C0F) RUN	Custom Address Of Stop Command	V/F SVC FVC PMVF PMSVC PMFVC Defines the address of stop command.	0005 (0000~FFFF)	
F12.16 (0x0C10) RUN	Custom Address Of Reset Command	V/F SVC FVC PMVF PMSVC PMFVC Defines the address of reset command.	0007 (0000~FFFF)	
F12.19 (0x0C13) RUN	Master Sending Command Selection	V/F SVC FVC PMVF PMSVC PMFVC Master sending command selection. 0: Send run command; 1: Send running status	0 (0~1)	

Group F12.2x: Special Modbus Functions

Parameter Code (Address)	Name	Description	Default (Range)	Reference Source
F12.20 (0x0C14) STOP	RJ45 interface communication mode selection	V/F SVC FVC PMVF PMSVC PMFVC 0: dual-line keypad communication 1: Modbus slave (Related parameters are set with F12.2x) 2: Modbus master (Send parameters are set with F12.1x) 3: Defined by VEICHI Note: Models of T3 45 KW and above only support dual-line Keypad communication	0 (0~3)	F12.2x
F12.21 (0x0C15) STOP	RJ45 interface communication address	V/F SVC FVC PMVF PMSVC PMFVC The slave address when RJ45 interface is for Modbus communication.	1 (1~247)	
F12.22 (0x0C16) STOP	RJ45 interface communication baud rate	V/F SVC FVC PMVF PMSVC PMFVC The baud rate when RJ45 interface is for Modbus communication. 0: 1200 bps 1: 2400 bps 2: 4800 bps 3: 9600 bps 4: 19200 bps 5: 38400 bps	3 (0~5)	
F12.23 (0x0C17) STOP	RJ45 interface data format	V/F SVC FVC PMVF PMSVC PMFVC The data format when RJ45 interface is for Modbus communication. 0: (N, 8, 1) No check, data bits: 8, stop bits: 1 1: (E, 8, 1) Even parity check, data bits: 8, stop bits: 1 2: (O, 8, 1) Odd parity check, data bits: 8, stop	0 (0~5)	

		bits: 1 3: (N, 8, 2) No check, data bits: 8, stop bits: 2 4: (E, 8, 2) Even parity check, data bits: 8, stop bits: 2 5: (O, 8, 2) Odd parity check, data bits: 8, stop bits: 2		
F12.24 (0x0C18) RUN	RJ45 interface transmission response processing	V/F SVC FVC PMVF PMSVC PMFVC The transmission response processing when RJ45 interface is for Modbus communication. 0: Write with response 1: Write without response	0 (0~1)	
F12.25 (0x0C19) RUN	RJ45 interface communication response delay	V/F SVC FVC PMVF PMSVC PMFVC The response delay when RJ45 interface is for Modbus communication.	0ms (0ms~5000ms)	
F12.26 (0x0C1A) RUN	RJ45 interface communication timeout fault time	V/F SVC FVC PMVF PMSVC PMFVC The timeout fault time when RJ45 interface is for Modbus communication.	1.0s (0.1s~100.0s)	
F12.27 (0x0C1B) RUN	RJ45 interface communication disconnection processing	V/F SVC FVC PMVF PMSVC PMFVC The disconnection processing when RJ45 interface is for Modbus communication. 0: Do not detect timeout fault 1: Alarm and free stop 2: Warning and keep running 3: Forced stop	0 (0~3)	

Group F12.3x: PROFIBUS-DP Communication

Parameter Code (Address)	Name	Description	Default (Range)	Reference Source
F12.30 (0x0C1E) RUN	DP card address	V/F SVC FVC PMVF PMSVC PMFVC Sets different values for different slave stations.	1 (1~247)	F12.3x
F12.32 (0x0C20) STOP	DP master-slave communication fault action	V/F SVC FVC PMVF PMSVC PMFVC 0: Do not detect 1: Alarm and free stop 2: Warning and keep running	0 (0~2)	

Note: The extension card does not support hot swapping.

Group F12.4x: CAN Communication

Parameter Code (Address)	Name	Description	Default (Range)	Reference Source
F12.40 (0x0C28) RUN	CAN Mode Selection	V/F SVC FVC PMVF PMSVC PMFVC 0: Slave station 1: Master station defined by VEICHI	0 (0~1)	F12.4x
F12.41 (0x0C29) RUN	CAN Communication Address	V/F SVC FVC PMVF PMSVC PMFVC Set the address for the slave station	1 (1~247)	
F12.42 (0x0C2A) RUN	CAN Communication Baud Rate	V/F SVC FVC PMVF PMSVC PMFVC 0: 20kbps 1: 50kbps	3 (0~6)	

		2: 100kbps 3: 125kbps 4: 250kbps 5: 500kbps 6: 1Mbps		
F12.43 (0x0C2B) RUN	CAN Master-Slave Communication Fault Action	V/F SVC FVC PMVF PMSVC PMFVC 0: Do not detect 1: Alarm and free stop 2: Warning and keep running	0 (0~2)	

Note: The extension card does not support hot swapping.

Group F12.5x~Group F12.6x: extension Port EX-A and EX-B Communication

Parameter Code (Address)	Name	Description	Default (Range)	Reference Source
F12.50 (0x0C32) RUN	Expansion port communication disconnection processing	V/F SVC FVC PMVF PMSVC PMFVC LED "0": EX-A port disconnection action mode 0: Do not detect 1: Alarm and free stop 2: Warning and keep running LED "00": EX-B port disconnection action mode 0: Do not detect 1: Alarm and free stop 2: Warning and keep running	0000 (0000~0022)	F12.5x
F12.51 (0x0C33) RUN	Extension port EX-A parameter updating	V/F SVC FVC PMVF PMSVC PMFVC 0: Do not update 1: Power-up has updated initial values 2: The initial values are restored for extension port EX-A parameters	0 (0~2)	
F12.52 (0x0C34) RUN	Extension port EX-B parameter updating	V/F SVC FVC PMVF PMSVC PMFVC 0: Do not update 1: Power-up has updated initial values 2: The initial values are restored for extension port EX-B parameters	0 (0~2)	
F12.53 (0x0C35) RUN	Extension port EX-A monitor frame address group 1	V/F SVC FVC PMVF PMSVC PMFVC Ones and LED"00"s: Lower 8 bits of address 00-63 Hundreds and LED"0000"s: Higher 8 bits of address 00-07	0001 (0000~0763)	
F12.54 (0x0C36) RUN	Extension port EX-A monitor frame address group 2	V/F SVC FVC PMVF PMSVC PMFVC The same as above	0002 (0000~0763)	
F12.55 (0x0C37) RUN	Extension port EX-A monitor frame address group 3	V/F SVC FVC PMVF PMSVC PMFVC The same as above	0007 (0000~0763)	
F12.56 (0x0C38) RUN	Extension port EX-A monitor frame address group 4	V/F SVC FVC PMVF PMSVC PMFVC The same as above	0011 (0000~0763)	
F12.57 (0x0C39) RUN	Extension port EX-B monitor frame address group 1	V/F SVC FVC PMVF PMSVC PMFVC The same as above	0001 (0000~0763)	

F12.58 (0x0C3A) RUN	Extension port EX-B monitor frame address group 2	V/F SVC FVC PMVF PMSVC PMFVC The same as above	0002 (0000~0763)	
F12.59 (0x0C3B) RUN	Extension port EX-B monitor frame address group 3	V/F SVC FVC PMVF PMSVC PMFVC The same as above	0007 (0000~0763)	
F12.60 (0x0C3C) RUN	Extension port EX-B monitor frame address group 4	V/F SVC FVC PMVF PMSVC PMFVC The same as above	0011 (0000~0763)	

Note: The extension card does not support hot swapping.

10.17 Group F13: Process PID Control

F13.00~F13.06: PID Setting and Feedback

Parameter Code (Address)	Name	Description	Default (Range)	Reference Source
F13.00 (0x0D00) RUN	PID control given source	V/F SVC FVC PMVF PMSVC PMFVC 0: Keypad digital 1: Keypad potentiometer (optional external single-line keypad) 2: AI1 3: AI2 4: Reserved 5: Terminal pulse PUL 6: RS485 communication 7: Optional card 8: Terminal selection 9: Active current set via communication	0 (0~9)	F13.0x
F13.01 (0x0D01) RUN	Keypad digital of PID given /feedback	V/F SVC FVC PMVF PMSVC PMFVC PID given/feedback with keypad digital.	50.0% (0.0%~100.0%)	
F13.02 (0x0D02) RUN	PID given change time	V/F SVC FVC PMVF PMSVC PMFVC PID given change time. Acceleration/deceleration time between 0% and 100%.	1.00s (0.00s~60.00s)	
F13.03 (0x0D03) RUN	PID control feedback source	V/F SVC FVC PMVF PMSVC PMFVC 0: PID feedback with keypad digital 1: Keypad potentiometer (optional external single-line keypad) 2: AI1 3: AI2 4: Reserved 5: Terminal pulse PUL feedback 6: Feedback via RS485 communication 7: Option card 8: Terminal selection 9: Local active current	2 (0~9)	
F13.04 (0x0D04) RUN	Feedback signal low-pass filter time	V/F SVC FVC PMVF PMSVC PMFVC Feedback signal low-pass filter time.	0.010s (0.000s~6.000s)	
F13.05 (0x0D05) RUN	Feedback signal gain	V/F SVC FVC PMVF PMSVC PMFVC Feedback signal gain.	1.00 (0.00~10.00)	
F13.06 (0x0D06) RUN	Feedback signal range	V/F SVC FVC PMVF PMSVC PMFVC Feedback signal range.	100.0 (0.0~100.0)	

F13.07~F13.24: PID Adjustment

Parameter Code (Address)	Name	Description	Default (Range)	Reference Source
F13.07 (0x0D07) RUN	PID control selection	V/F SVC FVC PMVF PMSVC PMFVC LED"0": Feedback characteristic selection 0: Positive characteristic 1: Negative characteristic LED"00": Reserved LED"000": Reserved LED"0000": Differential adjustment attribute 0: Differentiate deviation 1: Differentiate feedback	0100 (0000~1111)	F13.1x
F13.08 (0x0D08) RUN	PID preset output	V/F SVC FVC PMVF PMSVC PMFVC 100% of the preset output corresponds to the maximum frequency output.	100.0% (0.0%~100.0%)	
F13.09 (0x0D09) RUN	PID preset output running time	V/F SVC FVC PMVF PMSVC PMFVC After PID control is started, the drive output follows the PID preset output first, and it lasts for the PID preset output running time before running according to the PID closed-loop characteristics.	0.0s (0.0s~6500.0s)	
F13.10 (0x0D0A) RUN	PID control deviation limit	V/F SVC FVC PMVF PMSVC PMFVC The maximum allowable deviation of PID feedback value relative to the PID set value. When the feedback value is within this range, PID regulation stops and the output remains unchanged. Appropriate use of this function is helpful to minimize the conflict between the accuracy and stability of system output.	0.0s (0.0s~6500.0s)	
F13.11 (0x0D0B) RUN	Proportional gain P1	V/F SVC FVC PMVF PMSVC PMFVC Determines the regulation intensity of the whole PID regulator. The larger the gain, the greater the regulation intensity. However, too large gain is likely to generate oscillation.	0.100 (0.000~4.000)	
F13.12 (0x0D0C) RUN	Integral time I1	V/F SVC FVC PMVF PMSVC PMFVC Determines the integral regulation intensity of the PID regulator. The shorter the integral time, the greater the regulation intensity. The PID regulation will be invalid when the integral time is 0.	1.0s (0.0s~600.0s)	
F13.13 (0x0D0D) RUN	Differentiation time D1	V/F SVC FVC PMVF PMSVC PMFVC Determine the regulation intensity of the PID regulator for the deviation or feedback signal change rate. The regulation is variable according to the trends of change to suppress the changes in feedback signals.	0.000s (0.000s~6.000s)	
F13.14 (0x0D0E) RUN	Proportional gain P2	V/F SVC FVC PMVF PMSVC PMFVC Determines the regulation intensity of the whole PID regulator. The larger the gain, the greater the regulation intensity. However, too large gain is likely to generate oscillation.	0.100 (0.000~4.000)	
F13.15 (0x0D0F) RUN	Integral time I2	V/F SVC FVC PMVF PMSVC PMFVC Determines the integral regulation intensity of the PID regulator. The shorter the integral time, the greater the regulation intensity. The PID regulation will be invalid when the integral time is 0.	1.0s (0.0s~600.0s)	

F13.16 (0x0D10) RUN	Differentiation time D2	V/F SVC FVC PMVF PMSVC PMFVC Determine the regulation intensity of the PID regulator for the deviation or feedback signal change rate. The regulation is variable according to the trends of change to suppress the changes in feedback signals.	0.000s (0.000s~ 6.000s)	
F13.17 (0x0D11) RUN	PID parameter switching conditions	V/F SVC FVC PMVF PMSVC PMFVC 0: Do not switch 1: Switch with Xi terminal 2: Switch according to deviation	0 (0~2)	
F13.18 (0x0D12) RUN	Lower value of switching deviation	V/F SVC FVC PMVF PMSVC PMFVC The gain 1 parameter is used when the PID deviation is smaller than this value.	20.0% (0.0%~100.0%)	
F13.19 (0x0D13) RUN	Higher value of switching deviation	V/F SVC FVC PMVF PMSVC PMFVC The gain 2 parameter is used when the PID deviation is larger than this value.	80.0% (0.0%~100.0%)	
F13.21 (0x0D15) RUN	Differentiation limit	V/F SVC FVC PMVF PMSVC PMFVC The differential limit is used to set the range of the PID differential output. In a PID regulator, the function of differentiation is sensitive, as it is likely to cause system oscillation. Generally, the function of PID differentiation is limited to a small range.	5.0% (0.0%~100.0%)	
F13.22 (0x0D16) RUN	Upper limit of PID output	V/F SVC FVC PMVF PMSVC PMFVC Set the upper limit of PID output.	100.0% (0.0%~100.0%)	
F13.23 (0x0D17) RUN	Lower limit of PID output	V/F SVC FVC PMVF PMSVC PMFVC Set the lower limit of PID output.	0.0% (-100.0~ F13.22)	
F13.24 (0x0D18) RUN	PID output filter time	V/F SVC FVC PMVF PMSVC PMFVC The PID output filter time is used to filter the PID output. The filter will weaken the sudden changes of the PID regulation output result and degrade the response performance of the process closed-loop system.	0.000s (0.000s~ 6.000s)	

F13.25~F13.28: PID Feedback Disconnection Judgment

Parameter Code (Address)	Name	Description	Default (Range)	Reference Source
F13.25 (0x0D19) RUN	Feedback disconnection action selection	V/F SVC FVC PMVF PMSVC PMFVC 0: Keep PID operation without alarm 1: Stop and alarm 2: Keep PID operation and output an alarm signal 3: Run at the current frequency and output an alarm signal	0 (0~3)	F13.2x
F13.26 (0x0D1A) RUN	Feedback disconnection detection time	V/F SVC FVC PMVF PMSVC PMFVC When the drive is in running state, the sensor is considered to disconnection when the detected feedback signal has been larger than the upper limit of disconnection alarm or smaller than the lower limit of disconnection alarm, And it Lasts longer than the disconnection time.	1.0s (0.0s~120.0s)	
F13.27 (0x0D1B) RUN	Disconnection alarm upper limit	V/F SVC FVC PMVF PMSVC PMFVC Sets the upper limit of PID sensor disconnection detection. The sensor is considered to disconnection when the feedback signal has been larger than the upper limit of disconnection alarm for the delay time in [F13.26].	100.0% (0.0%~100.0%)	
F13.28 (0x0D1C) RUN	Disconnection alarm lower limit	V/F SVC FVC PMVF PMSVC PMFVC Sets the lower limit of PID sensor disconnection detection. The sensor is considered to disconnection when the feedback signal has been smaller than the lower limit of disconnection alarm for the delay time in [F13.26].	0.0% (0.0%~100.0%)	

F13.29~F13.33: Sleep Function

Parameter Code (Address)	Name	Description	Default (Range)	Reference Source
F13.29 (0x0D1D) RUN	Sleep selection	V/F SVC FVC PMVF PMSVC PMFVC 0: Invalid 1: Valid	0 (0~1)	F13.3x
F13.30 (0x0D1E) RUN	Sleep frequency	V/F SVC FVC PMVF PMSVC PMFVC When the sleep function is enabled, sleep judgment is conducted when the output frequency of PID regulation is lower than the sleep frequency.	10.00Hz (0.00Hz~50.00Hz)	
F13.31 (0x0D1F) RUN	Sleep delay time	V/F SVC FVC PMVF PMSVC PMFVC After sleep judgment starts, the drive enters sleep status after the sleep delay time (i.e. blocking output after decelerating to zero frequency.)	60.0s (0.0s~3600.0s)	
F13.32 (0x0D20) RUN	Wake-up deviation	V/F SVC FVC PMVF PMSVC PMFVC When the PID feedback characteristic is positive: The PID setting minus the wake-up deviation is compared with the PID feedback. The drive will exits the sleep state and enters the normal running state if the difference remains greater than the PID feedback for the wake-up delay time. When the PID feedback characteristic is reverse: The PID setting plus the wake-up deviation is compared with the PID feedback. The drive will exits the sleep state and enters the normal	5.0% (0.0%~50.0%)	

		operation state if the sum remains greater than the PID feedback for the wake-up delay time.		
F13.33 (0x0D21) RUN	Wake-up delay time	V/F SVC FVC PMVF PMSVC PMFVC The drive exits the sleep state and enters the normal operation state after the wake-up delay time if the wake-up conditions are met.	1.0s (0.0s~60.0s)	

10.18 Group F14: Multi-Speed and Simple PLC

F14.00~F14.14: Multi-Speed Frequency Setting

Parameter Code (Address)	Name	Description	Default (Range)	Reference Source
F14.00 (0x0E00) RUN	PLC multi-speed 1	V/F SVC FVC PMVF PMSVC PMFVC Set the frequency of the 1st stage in PLC program operation and multi-speed control.	10.00 Hz (0.00 Hz - maximum frequency)	F14.0x
F14.01 (0x0E01) RUN	PLC multi-speed 2	V/F SVC FVC PMVF PMSVC PMFVC Set the frequency of the 2nd stage in PLC program operation and multi-speed control.	20.00 Hz (0.00 Hz - maximum frequency)	
F14.02 (0x0E02) RUN	PLC multi-speed 3	V/F SVC FVC PMVF PMSVC PMFVC Set the frequency of the 3rd stage in PLC program operation and multi-speed control.	30.00 Hz (0.00 Hz - maximum frequency)	
F14.03 (0x0E03) RUN	PLC multi-speed 4	V/F SVC FVC PMVF PMSVC PMFVC Set the frequency of the 4th stage in PLC program operation and multi-speed control.	40.00 Hz (0.00 Hz - maximum frequency)	
F14.04 (0x0E04) RUN	PLC multi-speed 5	V/F SVC FVC PMVF PMSVC PMFVC Set the frequency of the 5th stage in PLC program operation and multi-speed control.	50.00 Hz (0.00 Hz - maximum frequency)	
F14.05 (0x0E05) RUN	PLC multi-speed 6	V/F SVC FVC PMVF PMSVC PMFVC Set the frequency of the 6th stage in PLC program operation and multi-speed control.	40.00 Hz (0.00 Hz - maximum frequency)	
F14.06 (0x0E06) RUN	PLC multi-speed 7	V/F SVC FVC PMVF PMSVC PMFVC Set the frequency of the 7th stage in PLC program operation and multi-speed control.	30.00 Hz (0.00 Hz - maximum frequency)	
F14.07 (0x0E07) RUN	PLC multi-speed 8	V/F SVC FVC PMVF PMSVC PMFVC Set the frequency of the 8th stage in PLC program operation and multi-speed control.	20.00 Hz (0.00 Hz - maximum frequency)	
F14.08 (0x0E08) RUN	PLC multi-speed 9	V/F SVC FVC PMVF PMSVC PMFVC Set the frequency of the 9th stage in PLC program operation and multi-speed control.	10.00 Hz (0.00 Hz - maximum frequency)	
F14.09 (0x0E09) RUN	PLC multi-speed 10	V/F SVC FVC PMVF PMSVC PMFVC Set the frequency of the 10th stage in PLC program operation and multi-speed control.	20.00 Hz (0.00 Hz - maximum frequency)	
F14.10 (0x0E0A) RUN	PLC multi-speed 11	V/F SVC FVC PMVF PMSVC PMFVC Set the frequency of the 11th stage in PLC program operation and multi-speed control.	30.00 Hz (0.00 Hz - maximum frequency)	

			frequency)	
F14.11 (0x0E0B) RUN	PLC multi-speed 12	V/F SVC FVC PMVF PMSVC PMFVC Set the frequency of the 12th stage in PLC program operation and multi-speed control.	40.00 Hz (0.00 Hz - maximum frequency)	
F14.12 (0x0E0C) RUN	PLC multi-speed 13	V/F SVC FVC PMVF PMSVC PMFVC Set the frequency of the 13th stage in PLC program operation and multi-speed control.	50.00 Hz (0.00 Hz - maximum frequency)	
F14.13 (0x0E0D) RUN	PLC multi-speed 14	V/F SVC FVC PMVF PMSVC PMFVC Set the frequency of the 14th stage in PLC program operation and multi-speed control.	40.00 Hz (0.00 Hz - maximum frequency)	
F14.14 (0x0E0E) RUN	PLC multi-speed 15	V/F SVC FVC PMVF PMSVC PMFVC Set the frequency of the 15th stage in PLC program operation and multi-speed control.	30.00 Hz (0.00 Hz - maximum frequency)	

F14.15: PLC Running Mode Selection

Parameter Code (Address)	Name	Description	Default (Range)	Reference Source
F14.15 (0x0E0F) RUN	PLC running mode selection	V/F SVC FVC PMVF PMSVC PMFVC LED "0": Cycle mode 0: Stop after single cycle 1: Keep repeating 2: Hold the final value after a single cycle LED "00": Time unit 0: Second (s) 1: Minute (m) 2: Hour (h) LED "000": Power-off storage mode 0: Not stored 1: Stored LED "0000": Start mode 0: Re-run from stage one 1: Re-run from the stage upon stop last time 2: Re-run from the remaining time of the stage upon stop last time	0000 (0000~2122)	F14.15

F14.16~F14.30: PLC Running Time Selection

Parameter Code (Address)	Name	Description	Default (Range)	Reference Source
F14.16 (0x0E10) RUN	PLC segment 1 running time	V/F SVC FVC PMVF PMSVC PMFVC Set the running time for the 1st segment of PLC program.	10.0(s/m/h) (0.0(s/m/h)~6500.0(s/m/h))	F14.1x
F14.17 (0x0E11) RUN	PLC segment 2 running time	V/F SVC FVC PMVF PMSVC PMFVC Set the running time for the 2nd segment of PLC program.	10.0(s/m/h) (0.0(s/m/h)~6500.0(s/m/h))	
F14.18 (0x0E12) RUN	PLC segment 3 running time	V/F SVC FVC PMVF PMSVC PMFVC Set the running time for the 3rd segment of PLC program.	10.0(s/m/h) (0.0(s/m/h)~6500.0(s/m/h))	
F14.19 (0x0E13) RUN	PLC segment 4 running time	V/F SVC FVC PMVF PMSVC PMFVC Set the running time for the 4th segment of PLC program.	10.0(s/m/h) (0.0(s/m/h)~6500.0(s/m/h))	
F14.20 (0x0E14) RUN	PLC segment 5 running time	V/F SVC FVC PMVF PMSVC PMFVC Set the running time for the 5th segment of PLC program.	10.0(s/m/h) (0.0(s/m/h)~6500.0(s/m/h))	
F14.21 (0x0E15) RUN	PLC segment 6 running time	V/F SVC FVC PMVF PMSVC PMFVC Set the running time for the 6th segment of PLC program.	10.0(s/m/h) (0.0(s/m/h)~6500.0(s/m/h))	
F14.22 (0x0E16) RUN	PLC segment 7 running time	V/F SVC FVC PMVF PMSVC PMFVC Set the running time for the 7th segment of PLC program.	10.0(s/m/h) (0.0(s/m/h)~6500.0(s/m/h))	
F14.23 (0x0E17) RUN	PLC segment 8 running time	V/F SVC FVC PMVF PMSVC PMFVC Set the running time for the 8th segment of PLC program.	10.0(s/m/h) (0.0(s/m/h)~6500.0(s/m/h))	
F14.24 (0x0E18) RUN	PLC segment 9 running time	V/F SVC FVC PMVF PMSVC PMFVC Set the running time for the 9th segment of PLC program.	10.0(s/m/h) (0.0(s/m/h)~6500.0(s/m/h))	
F14.25 (0x0E19)	PLC segment 10 running time	V/F SVC FVC PMVF PMSVC PMFVC Set the running time for the 10th segment of PLC	10.0(s/m/h) (0.0(s/m/h)~	

RUN		program.	6500.0(s/m/h))	
F14.26 (0x0E1A) RUN	PLC segment 11 running time	V/F SVC FVC PMVF PMSVC PMFVC Set the running time for the 11th segment of PLC program.	10.0(s/m/h) (0.0(s/m/h)~ 6500.0(s/m/h))	
F14.27 (0x0E1B) RUN	PLC segment 12 running time	V/F SVC FVC PMVF PMSVC PMFVC Set the running time for the 12th segment of PLC program.	10.0(s/m/h) (0.0(s/m/h)~ 6500.0(s/m/h))	
F14.28 (0x0E1C) RUN	PLC segment 13 running time	V/F SVC FVC PMVF PMSVC PMFVC Set the running time for the 13th segment of PLC program.	10.0(s/m/h) (0.0(s/m/h)~ 6500.0(s/m/h))	
F14.29 (0x0E1D) RUN	PLC segment 14 running time	V/F SVC FVC PMVF PMSVC PMFVC Set the running time for the 14th segment of PLC program.	10.0(s/m/h) (0.0(s/m/h)~ 6500.0(s/m/h))	
F14.30 (0x0E1E) RUN	PLC segment 15 running time	V/F SVC FVC PMVF PMSVC PMFVC Set the running time for the 15th segment of PLC program.	10.0(s/m/h) (0.0(s/m/h)~ 6500.0(s/m/h))	

F14.31~F14.45: PLC Direction and Acceleration/Deceleration Time Selection

Parameter Code (Address)	Name	Description	Default (Range)	Reference Source
F14.31 (0x0E1F) RUN	Direction and acceleration/de celeration time of plc segment 1	V/F SVC FVC PMVF PMSVC PMFVC LED"0": Running direction of this stage (compared with the running command) 0: Same direction 1: Reverse direction LED"00": Acceleration/deceleration time of this stage 0: Acceleration/deceleration time 1 1: Acceleration/deceleration time 2 2: Acceleration/deceleration time 3 3: Acceleration/deceleration time 4 LED"000": Reserved LED"0000": Reserved	0000 (0000~0031)	F14.3x
F14.32 (0x0E20) RUN	Direction and acceleration/de celeration time of plc segment 2	Same as F14.31.	0000 (0000~0031)	
F14.33 (0x0E21) RUN	Direction and acceleration/de celeration time of plc segment 3	Same as F14.31.	0000 (0000~0031)	
F14.34 (0x0E22) RUN	Direction and acceleration/de celeration time of plc segment 4	Same as F14.31.	0000 (0000~0031)	
F14.35 (0x0E23) RUN	Direction and acceleration/de celeration time of plc segment 5	Same as F14.31.	0000 (0000~0031)	
F14.36	Direction and acceleration/de	Same as F14.31.	0000	

(0x0E24) RUN	celeration time of plc segment 6		(0000~0031)	
F14.37 (0x0E25) RUN	Direction and acceleration/deceleration time of plc segment 7	Same as F14.31.	0000 (0000~0031)	
F14.38 (0x0E26) RUN	Direction and acceleration/deceleration time of plc segment 8	Same as F14.31.	0000 (0000~0031)	
F14.39 (0x0E27) RUN	Direction and acceleration/deceleration time of plc segment 9	Same as F14.31.	0000 (0000~0031)	
F14.40 (0x0E28) RUN	Direction and acceleration/deceleration time of plc segment 10	Same as F14.31.	0000 (0000~0031)	
F14.41 (0x0E29) RUN	Direction and acceleration/deceleration time of plc segment 11	Same as F14.31.	0000 (0000~0031)	
F14.42 (0x0E2A) RUN	Direction and acceleration/deceleration time of plc segment 12	Same as F14.31.	0000 (0000~0031)	
F14.43 (0x0E2B) RUN	Direction and acceleration/deceleration time of plc segment 13	Same as F14.31.	0000 (0000~0031)	
F14.44 (0x02C) RUN	Direction and acceleration/deceleration time of plc segment 14	Same as F14.31.	0000 (0000~0031)	
F14.45 (0x0E2D) RUN	Direction and acceleration/deceleration time of plc segment 15	Same as F14.31.	0000 (0000~0031)	

10.19 Group F15: Reserved

10.20 Group F16: Tension Control

Parameter Code (Address)	Name	Description	Default (Range)	Reference Source
F16.01 (0x5001) RUN	Winding mode setting	V/F SVC FVC PMVF PMSVC PMFVC 0: Winding 1: Unwinding 2: Terminal selection	0 (0~2)	F16.0x

F16.02 (0x5002) RUN	Mechanical transmission ratio	V/F SVC FVC PMVF PMSVC PMFVC Sets the transmission ratio between the motor and the roll.	1.00 (0.01~300.00)	
---------------------------	-------------------------------------	--	-----------------------	--

F16.03 - F16.09: Tension Setting

Parameter Code (Address)	Name	Description	Default (Range)	Reference Source
F16.03 (0x5003) STOP	Tension given selection	V/F SVC FVC PMVF PMSVC PMFVC LED"0": Tension given channel A LED "00": Tension given channel B 0: Tension given by keypad digital 1: Keypad potentiometer (optional outer single-line keypad) 2: AI1 3: AI2 4: Reserved 5: PUL 6: RS485 communication (0x300B) LED "000": Decimal point digits of tension setting 0: 0.1 units 1: 1 unit 2: 10 units	0000 (0000~0266)	F16.0x
F16.04 (0x5004) STOP	Tension keypad digital given	V/F SVC FVC PMVF PMSVC PMFVC Sets and modifies tension with keypad digital. There is no decimal point for motor power above 37 kW.	0 N (0 N - maximum tension)	
F16.05 (0x5005) STOP	Maximum tension	V/F SVC FVC PMVF PMSVC PMFVC Set the maximum tension limit for all channels. There is no decimal point for motor power above 37 kW.	1000N (0N~6000N)	
F16.06 (0x5006) STOP	Tension taper coefficient	V/F SVC FVC PMVF PMSVC PMFVC Set the tension taper coefficient.	0.0% (0.0%~100.0%)	
F16.07 (0x5007) STOP	Taper compensation correction	V/F SVC FVC PMVF PMSVC PMFVC Sets the taper compensation correction coefficient.	0mm (0mm~10000mm)	
F16.08 (0x5008) RUN	Zero speed threshold	V/F SVC FVC PMVF PMSVC PMFVC Set the zero speed threshold.	1.00Hz (0.00Hz~50.00Hz)	
F16.09 (0x5009) RUN	Zero speed tension gain	V/F SVC FVC PMVF PMSVC PMFVC Set the tension gain value in zero speed mode.	100.0% (0.0%~500.0%)	

F16.12~F16.16: Friction Compensation

Parameter Code (Address)	Name	Description	Default (Range)	Reference Source
F16.12 (0x500C) RUN	Static friction compensation coefficient	V/F SVC FVC PMVF PMSVC PMFVC Set the static friction compensation coefficient.	0.0% (0.0%~50.0%)	F16.1x
F16.13 (0x500D) RUN	Static friction compensation delay time	V/F SVC FVC PMVF PMSVC PMFVC Set the static friction compensation delay time.	2.0s (0.0s~60.0s)	

F16.14 (0x500E) RUN	Static friction compensation cutoff frequency	V/F SVC FVC PMVF PMSVC PMFVC Set the static friction compensation cutoff frequency.	2.00 Hz (0.00 Hz - maximum frequency)	
F16.15 (0x500F) RUN	Start Coefficient of sliding friction compensation	V/F SVC FVC PMVF PMSVC PMFVC Set the start coefficient of sliding friction compensation.	0.0% (0.0%~50.0%)	
F16.16 (0x5010) RUN	End coefficient of sliding friction compensation	V/F SVC FVC PMVF PMSVC PMFVC Set the end coefficient of sliding friction compensation.	0.0% (0.0%~50.0%)	

F16.30~F16.32: Material Interruption Detection

Parameter Code (Address)	Name	Description	Default (Range)	Reference Source
F16.30 (0x501E) RUN	Material interruption detection selection	V/F SVC FVC PMVF PMSVC PMFVC LED "0": Detection Signal Input Source 0: Material interruption detection Invalid 1: Set with keypad potentiometer 2: AI1 3: AI2 4: Reserved 5: PUL LED "00": Material Interruption Handling 0: Warning and keep running 1: Alarm and Stop	0000 (0000~0015)	F16.3x
F16.31 (0x501F) RUN	Material interruption detection threshold	V/F SVC FVC PMVF PMSVC PMFVC Sets the material interruption detection threshold.	100.0% (0.0%~100.0%)	
F16.32 (0x5020) RUN	Material interruption detection delay	V/F SVC FVC PMVF PMSVC PMFVC Sets the material interruption detection delay.	2.0s (0.1s~60.0s)	

F16.36~F16.38: Pre-drive

Parameter Code (Address)	Name	Description	Default (Range)	Reference Source
F16.36 (0x5024) STOP	Pre-drive function selection	V/F SVC FVC PMVF PMSVC PMFVC 0: Pre-drive invalid 1: Manual 2: Automatic	0 (0~2)	F16.3x
F16.37 (0x5025) STOP	Pre-drive frequency gain	V/F SVC FVC PMVF PMSVC PMFVC Set the pre-drive frequency gain.	105.0% (0.0%~200.0%)	
F16.38 (0x5026) STOP	Pre-drive torque gain	V/F SVC FVC PMVF PMSVC PMFVC Set the pre-drive torque gain.	105.0% (0.0%~200.0%)	

F16.42~F16.43: Stop and Brake Hold

Parameter Code (Address)	Name	Description	Default (Range)	Reference Source
F16.42 (0x502A) RUN	Stop and brake hold frequency	V/F SVC FVC PMVF PMSVC PMFVC Set the threshold value for stop and brake hold judgment frequency.	2.00 Hz (0.01 Hz - maximum frequency)	F16.4x
F16.43 (0x502B) RUN	Stop and brake hold time	V/F SVC FVC PMVF PMSVC PMFVC Set the stop and brake hold time.	0.0s (0.0s~600.0s)	

F16.44~F16.55: Roll Diameter Parameter Setting

Parameter Code (Address)	Name	Description	Default (Range)	Reference Source
F16.44 (0x502C) STOP	Roll diameter calculation method selection	V/F SVC FVC PMVF PMSVC PMFVC 0: Initial roll diameter, not calculated 1: Calculated with linear velocity 2: Calculated with thickness 3: Reserved 4: Set with AI1 5: Set with AI2 6: Reserved 7: Set with PUL 8: Set via RS485 communication (0x300C)	0 (0~8)	F16.4x
F16.45 (0x502D) STOP	Maximum roll diameter	V/F SVC FVC PMVF PMSVC PMFVC Set the maximum roll diameter limit.	500mm (1mm~10000mm)	
F16.46 (0x502E) STOP	Roll shaft diameter	V/F SVC FVC PMVF PMSVC PMFVC Set the roll shaft diameter value.	100 mm (1 mm - maximum roll diameter)	
F16.47 (0x502F) STOP	Initial roll diameter source selection	V/F SVC FVC PMVF PMSVC PMFVC 0: Terminal selection F16.48 - F16.50 1: Reserved 2: AI1 3: AI2 4: Reserved 5: PUL	0 (0~5)	
F16.48 (0x5030) RUN	Initial roll diameter 1	V/F SVC FVC PMVF PMSVC PMFVC Set initial roll diameter 1.	100 mm (1 mm - maximum roll diameter)	
F16.49 (0x5031) RUN	Initial roll diameter 2	V/F SVC FVC PMVF PMSVC PMFVC Set initial roll diameter 2.	100 mm (1 mm - maximum roll diameter)	
F16.50 (0x5032) RUN	Initial roll diameter 3	V/F SVC FVC PMVF PMSVC PMFVC Set initial roll diameter 3.	100 mm (1 mm - maximum roll diameter)	
F16.51 (0x5033) RUN	Roll diameter reset selection	V/F SVC FVC PMVF PMSVC PMFVC 0: Manual reset of roll diameter 1: Automatic reset of roll diameter	0 (0~1)	
F16.54 (0x5036) RUN	Roll diameter change Rate limit	V/F SVC FVC PMVF PMSVC PMFVC Set the limit of roll diameter change rate.	10.00mm/s (0.00mm/s~200.00 mm/s)	
F16.55 (0x5037) RUN	Roll diameter change direction	V/F SVC FVC PMVF PMSVC PMFVC Set the limit of roll diameter change direction.	0 (0~1)	

F16.56~F16.63: Roll Diameter Calculation with Linear Velocity

Parameter Code (Address)	Name	Description	Default (Range)	Reference Source
F16.56 (0x5038) RUN	Linear velocity input source	V/F SVC FVC PMVF PMSVC PMFVC 0: Terminal selection F16.60/F16.61 1: Keypad digital 2: Keypad potentiometer (optional outer single-line	0 (0~7)	F16.5x

		keypad) 3: AI1 4: AI2 5: Reserved 6: PUL 7: RS485 Communication (0x300D)		
F16.57 (0x5039) RUN	Maximum linear velocity	V/F SVC FVC PMVF PMSVC PMFVC Set the maximum linear velocity limit for all channels.	1000.0m/min (0.0m/min~ 6500.0m/min)	
F16.58 (0x503A) RUN	Keypad digital setting of linear velocity	V/F SVC FVC PMVF PMSVC PMFVC Sets and modifies the linear velocity Given with the keypad.	20.0 m/min (0.0 m/min - maximum linear velocity)	
F16.59 (0x503B) RUN	Minimum linear velocity for roll diameter calculation	V/F SVC FVC PMVF PMSVC PMFVC Set the minimum linear velocity when calculating the roll diameter with linear velocity.	2.0 m/min (0.0 m/min - maximum linear velocity)	
F16.60 (0x503C) RUN	Linear velocity given 1	V/F SVC FVC PMVF PMSVC PMFVC Set the set point 1 of linear velocity.	20.0 m/min (0.0 m/min - maximum linear velocity)	
F16.61 (0x503D) RUN	Linear velocity given 2	V/F SVC FVC PMVF PMSVC PMFVC Set the set point 2 of linear velocity.	20.0 m/min (0.0 m/min - maximum linear velocity)	
F16.63 (0x503F) RUN	Minimum frequency for roll diameter calculation	V/F SVC FVC PMVF PMSVC PMFVC Set the minimum frequency when calculating the roll diameter with linear velocity.	1.00Hz (0.00Hz~ 10.00Hz)	

F16.68~F16.70: Roll Diameter Calculation with Thickness

Parameter Code (Address)	Name	Description	Default (Range)	Reference Source
F16.68 (0x5044) RUN	Number of pulses per turn of winding roller	V/F SVC FVC PMVF PMSVC PMFVC Set the number of pulses received for each turn the winding roller rotates when calculating the roll diameter with thickness.	1 (1~65000)	F16.6x
F16.69 (0x5045) RUN	Number of turns per layer	V/F SVC FVC PMVF PMSVC PMFVC Set the number of turns required for winding a layer on the roll.	1 (1~10000)	
F16.70 (0x5046) RUN	Material thickness set with numbers	V/F SVC FVC PMVF PMSVC PMFVC Set the thickness of material.	0.01mm (0.01mm~ 100.00mm)	

6.82: Tension PID

Parameter Code (Address)	Name	Description	Default (Range)	Reference Source
F16.75 (0x504B) STOP	Enable tension PID	V/F SVC FVC PMVF PMSVC PMFVC 0: Disabled 1: Enabled	0 (0~1)	F16.7x
F16.76 (0x504C) STOP	Tension PID output reference	V/F SVC FVC PMVF PMSVC PMFVC 0: Given tension as reference source 1: Maximum tension as reference source	0 (0~1)	

	source			
F16.77 (0x504D) RUN	Tension PID maximum output percentage	V/F SVC FVC PMVF PMSVC PMFVC Set the percentage of tension PID output.	10.0% (0.0%~50.0%)	
F16.78 (0x504E) RUN	Tension PID feedback signal source	V/F SVC FVC PMVF PMSVC PMFVC 0: PID feedback with keypad digital 1: Keypad potentiometer (optional outer single-line keypad) 2: Analog AI1 feedback 3: Analog AI2 feedback 4: Reserved 5: Terminal pulse PUL feedback 6: RS485 communication feedback (0x300E)	2 (0~6)	
F16.79 (0x504F) RUN	Tension PID keypad feedback set with keypad digital	V/F SVC FVC PMVF PMSVC PMFVC Set and modifies the tension PID keypad feedback set with keypad digital.	50.0% (0.0%~100.0%)	
F16.80 (0x5050) RUN	Tension PID Feedback Signal Gain	V/F SVC FVC PMVF PMSVC PMFVC Set the gain of PID feedback signals for all channels.	1.00 (0.00~10.00)	
F16.81 (0x5051) RUN	Proportional Gain P	V/F SVC FVC PMVF PMSVC PMFVC Set the tension PID proportional gain.	0.500 (0.000~8.000)	
F16.82 (0x5052) RUN	Integral Time T	V/F SVC FVC PMVF PMSVC PMFVC Set the tension PID integral time.	0.5s (0.0s~600.0s)	

10.21 Group F17: Reserved

10.22 Group F18: Reserved

10.23 Group F19: User Programmable Group A

10.24 Group F20: User Programmable Group B

10.25 Group F21: Industry Application Extension Group

10.26 Group F22: Reserved

10.27 Group F23: Reserved

10.28 Group F24: Reserved

10.29 F25 group: AI and AO Correction

F25.00~F25.11: AI1 Correction

Parameter F5.41 is used to select voltage or current input. F5.41 set to "0" indicates voltage input, set to "1" indicates current input.

Parameter Code (Address)	Name	Description	Default (Range)	Reference Source
F25.00 (0x5900) RUN	AI1 measured voltage 1	V/F SVC FVC PMVF PMSVC PMFVC The first stage corrected voltage. The measured value is input into the parameter.	0.500V (0.000V~3.000V)	F25.0x
F25.01	AI1 monitor	V/F SVC FVC PMVF PMSVC PMFVC	0.500V	

(0x5901) RUN	voltage 1	The monitor value corresponding to the first stage corrected voltage. The value of C02.10 is input.	(0.000V~ 3.000V)	
F25.02 (0x5902) RUN	AI1 measured voltage 2	V/F SVC FVC PMVF PMSVC PMFVC The second stage corrected voltage. The measured value is input into the parameter.	5.000V (0.000V~ 7.000V)	
F25.03 (0x5903) RUN	AI1 monitor voltage 2	V/F SVC FVC PMVF PMSVC PMFVC The monitor value corresponding to the second stage corrected voltage. The value of C02.10 is input.	5.000V (0.000V~ 7.000V)	
F25.04 (0x5904) RUN	AI1 measured voltage 3	V/F SVC FVC PMVF PMSVC PMFVC The third stage corrected voltage. The measured value is input into the parameter.	9.500V (0.000V~ 11.000V)	
F25.05 (0x5905) RUN	AI1 monitor voltage 3	V/F SVC FVC PMVF PMSVC PMFVC The monitor value corresponding to the third stage corrected voltage. The value of C02.10 is input.	9.500V (0.000V~ 11.000V)	
F25.06 (0x5906) RUN	AI1 measured current 1	V/F SVC FVC PMVF PMSVC PMFVC The first stage corrected current. The measured value is input into the parameter.	1.000mA (0.000mA~ 6.000mA)	
F25.07 (0x5907) RUN	AI1 monitor current 1	V/F SVC FVC PMVF PMSVC PMFVC The monitor value corresponding to the first stage corrected current. The value of C02.10 is input.	1.000mA (0.000mA~ 6.000mA)	
F25.08 (0x5908) RUN	AI1 measured current 2	V/F SVC FVC PMVF PMSVC PMFVC The second stage corrected current. The measured value is input into the parameter.	10.000mA (0.000mA~ 14.000mA)	
F25.09 (0x5909) RUN	AI1 monitor current 2	V/F SVC FVC PMVF PMSVC PMFVC The monitor value corresponding to the second stage corrected current. The value of C02.10 is input.	10.000mA (0.000mA~ 14.000mA)	
F25.10 (0x590A) RUN	AI1 measured current 3	V/F SVC FVC PMVF PMSVC PMFVC The third stage corrected current. The measured value is input into the parameter.	19.000mA (0.000mA~ 21.000mA)	
F25.11 (0x590B) RUN	AI1 monitor current 3	V/F SVC FVC PMVF PMSVC PMFVC The monitor value corresponding to the third stage corrected current. The value of C02.10 is input.	19.000mA (0.000mA~ 21.000mA)	

F25.12~F25.23: AI2 Correction

Parameter F05.42 is used to select voltage or current input. F05.42 set to "0" indicates voltage input, set to "1" indicates current input.

Parameter Code (Address)	Name	Description	Default (Range)	Reference Source
F25.12 (0x590C) RUN	AI2 measured voltage 1	V/F SVC FVC PMVF PMSVC PMFVC The first stage corrected voltage. The measured value is input into the parameter.	0.500V (0.000V~ 3.000V)	F25.1x
F25.13 (0x590D) RUN	AI2 monitor voltage 1	V/F SVC FVC PMVF PMSVC PMFVC The monitor value corresponding to the first stage corrected voltage. The value of C02.11 is input.	0.500V (0.000V~ 3.000V)	
F25.14 (0x590E) RUN	AI2 measured voltage 2	V/F SVC FVC PMVF PMSVC PMFVC The second stage corrected voltage. The measured value is input into the parameter.	5.000V (0.000V~ 7.000V)	
F25.15 (0x590F) RUN	AI2 monitor voltage 2	V/F SVC FVC PMVF PMSVC PMFVC The monitor value corresponding to the second stage corrected voltage. The value of C02.11 is	5.000V (0.000V~ 7.000V)	

		input.		
F25.16 (0x5910) RUN	AI2 measured voltage 3	V/F SVC FVC PMVF PMSVC PMFVC The third stage corrected voltage. The measured value is input into the parameter.	9.500V (0.000V~ 11.000V)	
F25.17 (0x5911) RUN	AI2 monitor voltage 3	V/F SVC FVC PMVF PMSVC PMFVC The monitor value corresponding to the third stage corrected voltage. The value of C02.11 is input.	9.500V (0.000V~ 11.000V)	
F25.18 (0x5912) RUN	AI2 measured current 1	V/F SVC FVC PMVF PMSVC PMFVC The first stage corrected current. The measured value is input into the parameter.	1.000mA (0.000mA~ 6.000mA)	
F25.19 (0x5913) RUN	AI2 monitor current 1	V/F SVC FVC PMVF PMSVC PMFVC The monitor value corresponding to the first stage corrected current. The value of C02.11 is input.	1.000mA (0.000mA~ 6.000mA)	
F25.20 (0x5914) RUN	AI2 measured current 2	V/F SVC FVC PMVF PMSVC PMFVC The second stage corrected current. The measured value is input into the parameter.	10.000mA (0.000mA~ 14.000mA)	
F25.21 (0x5915) RUN	AI2 monitor current 2	V/F SVC FVC PMVF PMSVC PMFVC The monitor value corresponding to the second stage corrected current. The value of C02.11 is input.	10.000mA (0.000mA~ 14.000mA)	
F25.22 (0x5916) RUN	AI2 measured current 3	V/F SVC FVC PMVF PMSVC PMFVC The third stage corrected current. The measured value is input into the parameter.	19.000mA (0.000mA~ 21.000mA)	
F25.23 (0x5917) RUN	AI2 monitor current 3	V/F SVC FVC PMVF PMSVC PMFVC The monitor value corresponding to the third stage corrected current. The value of C02.11 is input.	19.000mA (0.000mA~ 21.000mA)	

F25.24~F25.35: AO Correction

Parameter F06.00 is used to select voltage or current input. F06.00 set to "0" indicates voltage input, set to "1" indicates current input.

Parameter Code (Address)	Name	Description	Default (Range)	Reference Source
F25.24 (0x5918) RUN	AO measured voltage 1	V/F SVC FVC PMVF PMSVC PMFVC The first stage corrected voltage. The measured value is input into the parameter.	0.500V (0.000V~ 3.000V)	F25.2x
F25.25 (0x5919) RUN	AO monitor voltage 1	V/F SVC FVC PMVF PMSVC PMFVC The monitor value corresponding to the first stage corrected voltage. The value of C02.12 is input.	0.500V (0.000V~ 3.000V)	
F25.26 (0x591A) RUN	AO measured voltage 2	V/F SVC FVC PMVF PMSVC PMFVC The second stage corrected voltage. The measured value is input into the parameter.	5.000V (0.000V~ 7.000V)	
F25.27 (0x591B) RUN	AO monitor voltage 2	V/F SVC FVC PMVF PMSVC PMFVC The monitor value corresponding to the second stage corrected voltage. The value of C02.12 is input.	5.000V (0.000V~ 7.000V)	
F25.28 (0x591C) RUN	AO measured voltage 3	V/F SVC FVC PMVF PMSVC PMFVC The third stage corrected voltage. The measured value is input into the parameter.	9.500V (0.000V~ 11.000V)	
F25.29 (0x591D) RUN	AO monitor voltage 3	V/F SVC FVC PMVF PMSVC PMFVC The monitor value corresponding to the third stage corrected voltage. The value of C02.12 is input.	9.500V (0.000V~ 11.000V)	
F25.30	AO measured	V/F SVC FVC PMVF PMSVC PMFVC	1.000mA	



(0x591E) RUN	current 1	The first stage corrected current. The measured value is input into the parameter.	(0.000mA~ 6.000mA)	
F25.31 (0x591F) RUN	AO monitor current 1	V/F SVC FVC PMVF PMSVC PMFVC The monitor value corresponding to the first correction current is input with C02.12 value.	1.000mA (0.000mA~ 6.000mA)	
F25.32 (0x5920) RUN	AO measured current 2	V/F SVC FVC PMVF PMSVC PMFVC The second stage corrected current. The measured value is input into the parameter.	10.000mA (0.000mA~ 14.000mA)	
F25.33 (0x5921) RUN	AO monitor current 2	V/F SVC FVC PMVF PMSVC PMFVC The monitor value corresponding to the second stage corrected current. The value of C02.12 is input.	10.000mA (0.000mA~ 14.000mA)	
F25.34 (0x5922) RUN	AO measured current 3	V/F SVC FVC PMVF PMSVC PMFVC The third stage corrected current. The measured value is input into the parameter.	19.000mA (0.000mA~ 21.000mA)	
F25.35 (0x5923) RUN	AO monitor current 3	V/F SVC FVC PMVF PMSVC PMFVC The monitor value corresponding to the third stage corrected current. The value of C02.12 is input.	19.000mA (0.000mA~ 21.000mA)	

10.30 Group C0x: Monitoring Parameters

Group C00.xx: Basic Monitoring

Parameter Code (Address)	Name	Minimum Unit	Description
C00.00 (0x2100)	Given frequency	0.01Hz/ 0.1Hz	Display the absolute value of given frequency of the drive.
C00.01 (0x2101)	Output frequency	0.01Hz/ 0.1Hz	Display the output frequency of the drive.
C00.02 (0x2102)	Output current	0.1A	Display the output current of the drive.
C00.03 (0x2103)	Input voltage	0.1V	Display the input voltage of the drive.
C00.04 (0x2104)	Output voltage	0.1V	Display the output voltage of the drive.
C00.05 (0x2105)	Mechanical speed	1rpm	Display the mechanical speed of the motor.
C00.06 (0x2106)	Given torque	0.1%	Display the set torque of the drive. Effective when vector is selected as the control mode.
C00.07 (0x2107)	Output torque	0.1%	Display the output torque of the drive.
C00.08 (0x2108)	PID given	0.1%	Display the set value of PID. Effective when PID is selected for the frequency setting channel.
C00.09 (0x2109)	PID feedback value	0.1%	Display the feedback value of PID . Effective when PID is selected for the frequency setting channel.
C00.10 (0x210A)	Output power	0.1%	Display the current output power of the drive.
C00.11 (0x210B)	DC-Bus voltage	0.1V	Display the current bus voltage of the drive.
C00.12 (0x210C)	Module temperature 1	0.1°C	The internal temperature of the drive.
C00.13 (0x210D)	Module temperature 2	0.1°C	--
C00.14 (0x210E)	Input terminal X connection status	--	The status of the multi-function input terminals is displayed as 1 (ON) or 0 (OFF). For example, when terminals X1 and X2 are ON, C00.14 is displayed as 11000000 .
C00.15 (0x210F)	Output terminal Y	--	The status of the multi-function output terminals is displayed as 1

	connection status		(ON) or 0 (OFF). For example, when terminal Y and relay are ON, C00.15 is displayed as  .
C00.16 (0x2110)	Analog AI1 input value	0.001V/0.001mA	F05.41 is used to select voltage or current input. F05.41 set to "0" indicates voltage input, while "1" indicates current input.
C00.17 (0x2111)	Analog AI2 input value	0.001V/0.001mA	F05.42 is used to select voltage or current input. F05.42 set to "0" indicates voltage input, while "1" indicates current input.
C00.18 (0x2112)	Reserved	--	--
C00.19 (0x2113)	Pulse signal PUL input value	0.001kHz/0.01kHz	The decimal point is determined by the selection in F05.30. There are 3 decimal digits when F05.30 is 0, and there are 2 decimal digits in other cases.
C00.20 (0x2114)	Analog output AO	0.01V/0.01mA/0.01kHz	F06.00 is used to select 0 V - 10 V or 0 mA - 20 mA, or pulse output.
C00.21 (0x2115)	Expanded AO output	0.01V/0.01mA	It is possible to select 0 V - 10 V or 0 mA - 20 mA, for use with an option card.
C00.22 (0x2116)	Counter value	1	--
C00.23 (0x2117)	Running time after power-on	0.1 hours	--
C00.24 (0x2118)	Cumulative running time of this drive	Hours	--
C00.25 (0x2119)	Drive capacity	0.1kVA	Capacity of the drive.
C00.26 (0x211A)	Rated voltage of drive	1V	The rated voltage of the drive.
C00.27 (0x211B)	Rated current of drive	0.1A	The rated current of the drive.
C00.28 (0x211C)	Software version	00.00	The version of the drive software.
C00.29 (0x211D)	PG feedback frequency	0.01Hz	The PG card detects the feedback signals from the encoder and converts them into a frequency values.
C00.30 (0x211E)	Timer time	1 second/minute/hour	The unit is determined by parameter F08.07.
C00.31 (0x211F)	PID output value	0.00%	The output value of the process PID control and regulation.
C00.32 (0x2120)	Drive Software Sub-Version	1	The time for updating the drive software.
C00.33 (0x2121)	Encoder feedback angle	1	The angle of the encoder feedback.
C00.34 (0x2122)	Z pulse cumulative error	1	The ABZ encoder detects A and B signals with Z pulses to judge whether the encoder has lost pulses.
C00.35 (0x2123)	Z pulse count	1	The count value of ABZ encoder passing Z pulses.
C00.36 (0x2124)	Fault warning code	1	The number corresponding to the fault code is displayed, and "0" indicates no fault.
C00.37 (0x2125)	Cumulative Power Consumption (low level)	1	Total power consumption = [C00.37 + C00.38 * 10,000]°
C00.38 (0x2126)	Cumulative power consumption (high level)	1	
C00.39 (0x2127)	Power factor angle	1°	--

C01.17 (0x2211)	Drive status of last fault	0x0000	LED"0": Running direction 0: Forward 1: Reverse LED"00": Running status 0: Stopped 1: Constant speed 2: Acceleration 3: Deceleration LED"000": Overvoltage and overcurrent 0: Normal 1: Overvoltage 2: Overcurrent 3: Overvoltage and Overcurrent LED LED"0000": Reserved
C01.18 (0x2212)	Input terminal status of last fault	--	The status of the multi-function input terminals is displayed as 1 (ON) or 0 (OFF) when the fault occurred. For example, when terminals X1 and X2 are ON, C01.08 is displayed as  .
C01.19 (0x2213)	Output terminal status of last fault	--	The status of the multi-function output terminals is displayed as 1 (ON) or 0 (OFF) when the fault occurred. For example, when terminal Y and the relay are ON, C01.09 is displayed as  .
C01.20 (0x2214)	Fault types of the first two times	--	Display the fault in characters.
C01.21 (0x2215)	Diagnosis information of the first two times	1	Display the fault code and fault sub-code in numbers. Check the corresponding solutions in the fault diagnosis section.
C01.22 (0x2216)	Fault types of the first three times	--	Display the fault in characters.
C01.23 (0x2217)	Diagnosis information of the first three times	1	Display the fault code and fault sub-code in numbers. Check the corresponding solutions in the fault diagnosis section.

Group C02.xx: Application Monitoring

Parameter Code (Address)	Name	Minimum Unit	Description
C02.00 (0x2300)	PID setting	0.1%	Display the PID set value.
C02.01 (0x2301)	PID feedback	0.1%	Display the PID feedback value.
C02.02 (0x2302)	PID output	0.1%	Display the PID output value.
C02.03 (0x2303)	PID Control status	1	--
C02.05 (0x2305)	PLC running stage	1	--
C02.06 (0x2306)	PLC segment frequency	0.01Hz	--
C02.07 (0x2307)	PLC segment running time	0.1(s/m/h)	The unit is related to the LED"00" setting of F14.15: second (s), minute (m), hour (h)
C02.08 (0x2308)	Forward and reverse command setting	1	--
C02.09 (0x2309)	Jogging command setting	1	--
C02.10 (0x230A)	AI1 pre-correction voltage/current	0.01V/0.01mA	F05.41 is used to select voltage or current input. F05.41 set to "0" indicates voltage input, while "1" indicates current input.
C02.11 (0x230B)	AI2 pre-correction voltage/current	0.01V/0.01mA	F05.42 is used to select voltage or current input. F05.42 set to "0" indicates voltage input, while "1" indicates current input.
C02.12 (0x230C)	AO pre-correction	0.01V/0.01mA	F06.00 is used to select voltage or current output. F06.00 set to "0"

	voltage/current		indicates voltage output, while "1, 2" indicate current output.
C02.13 (0x230D)	Expanded AO pre-correction voltage/current	0.01V/0.01mA	F06.10 is used to select voltage or current output. F06.10 set to "0" indicates voltage output, while "1, 2" indicate current output.
C02.14 (0x230E)	Reserved	--	--
C02.15 (0x230F)	Drive overload timing coefficient	0.1%	100% indicates that the overload time has elapsed.
C02.16 (0x2310)	Motor overload timing coefficient	0.1%	100% indicates that the overload time has elapsed.
C02.17~C02.18 (0x2311~0x2312)	Reserved		--
C02.19 (0x2313)	Times of cycle-by-cycle current limiting	1	The number of times when cycle-by-cycle current limiting has occurred.
C02.20~C02.24 (0x2314~0x2318)	Reserved		--
C02.25 (0x2319)	IO extension card analog 1	1	A per-unit value within the range of 0-10,000.
C02.26 (0x231A)	IO extension card analog 2	1	A per-unit value within the range of 0-10,000.
C02.27 (0x231B)	IO extension card analog 3	1	A per-unit value within the range of 0-10,000.
C02.28 (0x231C)	IO extension card input terminal status	1	Bit 0 - bit 4 correspond to the status of X6 - X10 terminals. 0: Invalid; 1: Valid.
C02.29 (0x231D)	Motor temperature detected by IO extension card	0.1 degrees	
C02.30 (0x231E)	IO extension card PUL count low level	1	
C02.31 (0x231F)	IO extension card PUL count high level	1	Total count = [C02.30 + C02.31*65535].
C02.32~C02.47 (0x2320~0x232F)	Stored parameter 1 after power-off - stored parameter 16 after power-off	1	Used with an option card.
C02.48~C02.49 (0x2330~0x2331)	Reserved	1	
C02.50~C02.59 (0x2332~0x233B)	Cache register 0 - cache register 9	1	Used with an option card.
C02.60 (0x233C)	Extension card A software version	1	The extension card software version on extension port A.
C02.61 (0x233D)	Extension card B software version	1	The extension card software version on extension port B.
C02.62 (0x233E)	External keypad version	1	The version of external keypad software.
C02.63 (0x233F)	Reserved	1	

Group C03.xx: Maintenance and Tension Control Monitoring

Parameter Code (Address)	Name	Minimum Unit	Description
C03.00 (0x2400)	Running time after power-up	0.1 hours	
C03.01 (0x2401)	Cumulative running time (hour)	1 hour	
C03.02 (0x2402)	Cumulative power-on time (hour)	1 hour	
C03.03 (0x2403)	Cumulative power-on time (minute)	1 minute	
C03.04 (0x2404)	Cooling fan running time	1 hour	
C03.05 (0x2405)	Cooling fan maintenance	1%	
C03.06 (0x2406)	Reserved	1%	
C03.07 (0x2407)	Main relay maintenance	1%	
C03.08~C03.19 (0x2408~0x2413)	Reserved		
C03.20 (0x2414)	Final tension setting	0.1N	The number of decimal places depends on the hundreds digit of F16.03.
C03.21 (0x2415)	Initial roll diameter value	1mm	
C03.22 (0x2416)	Current value of linear velocity	0.1m/min	
C03.23 (0x2417)	Current value of roll diameter	1mm	
C03.24 (0x2418)	Tension channel torque set value	0.1%	
C03.25 (0x2419)	Tension PID given	0.1%	
C03.26 (0x241A)	Tension PID feedback	0.1%	
C03.27 (0x241B)	Tension PID output	0~10000	
C03.28 (0x241C)	Static friction compensation value	0.1%	
C03.29 (0x241D)	Dynamic friction compensation value	0.1%	
C03.30 (0x241E)	Total friction compensation value	0.1%	
C03.31~C03.39 (0x241F~0x2427)	Reserved (tension function)		
C03.50 (0x2432)	Machine code 1	1	
C03.51 (0x2433)	Machine code 2	1	

0x2004 /0x3004	Upper frequency limit	R/W	0.01Hz (0.00Hz~320.00Hz)	The upper frequency limit is set via communication.
0x2005 /0x3005	Torque setting	R/W	0.0% (0.0%~100.0%)	The torque set point is set via communication.
0x2006 /0x3006	Torque control forward speed limit	R/W	0.0% (0.0%~100.0%)	The torque control forward speed limit is set via communication.
0x2007 /0x3007	Torque control reverse speed limit	R/W	0.0% (0.0%~100.0%)	The torque control reverse speed limit is set via communication.
0x2008 /0x3008	PID given	R/W	0.0% (0.0%~100.0%)	The PID set point is set via communication.
0x2009 /0x3009	PID feedback	R/W	0.0% (0.0%~100.0%)	The PID feedback value is set via communication.
0x200A /0x300A	VF separation voltage setting	R/W	0.0% (0.0%~100.0%)	An application parameter exclusive to drive power supply.
0x200B /0x300B	Tension setting	R/W	0.0% (0.0%~100.0%)	Unit-Specific tension parameter.
0x200C /0x300C	Roll diameter setting	R/W	0.0% (0.0%~100.0%)	Unit-Specific tension parameter.
0x200D /0x300D	Linear speed setting	R/W	0.0% (0.0%~100.0%)	Unit-Specific tension parameter.
0x200E /0x300E	Acceleration time 1	R/W	0.00s 0.00s~600.00s	Reads and writes the value of F01.22.
0x200F /0x300F	Deceleration time 1	R/W	0.00s (0.00s~600.00s)	Reads and writes the value of F01.23.
0x2010 /0x3010	Fault warning & warning code	R	0 (0~65535)	1-127 are fault codes, 128-159 are warning codes, and 0 indicates no fault.
0x2011 /0x3011	Torque current component	R	0.0% (0.0%~400.0%)	An application parameter exclusive to belt machine.
0x2012 /0x3012	Torque filter time	R/W	0.000s (0.000s~6.000s)	Reads and writes the value of F03.47.
0x2013 /0x3013	Reserved	R/W	--	Use with option cards.
0x2014 /0x3014	Reserved	R/W	--	Use with option cards.
0x2015 /0x3015	Reserved	R/W	--	Use with option cards.
0x2016 /0x3016	Reserved	R/W	--	Use with option cards.
0x2017 /0x3017	Reserved	R/W	--	Use with option cards.
0x2018 /0x3018	Terminal output control	W	Binary	Output terminal function. Select F6.21 - F06.24 to be 30 [Communication control output]. Bit0: Y terminal Bit1: Relay Bit2: Extension Y1 Bit3: Extension relay
0x2019 /0x3019	AO output	W	0.01 (0~100.00)	F06.01=18 [AO function output selection = Set via RS485 communication].
0x201A /0x301A	Extension AO output	W	0.01 (0~100.00)	F06.11=18 [Extension AO function output selection = Set via RS485 communication].
0x201B	Custom 1	R/W	0	Used with an option card.

/0x301B			(0~65535)	
0x201C /0x301C	Custom 2	R/W	0 (0~65535)	Used with an option card.
0x201D /0x301D	Custom 3	R/W	0 (0~65535)	Used with an option card.
0x201E /0x301E	Custom 4	R/W	0 (0~65535)	Used with an option card.
0x201F /0x301F	Custom 5	R/W	0 (0~65535)	Used with an option card.

0x310B	Tension setting	R/W	0.0% (0.0%~100.0%)	Unit-Specific Tension Parameter.
0x310C	Roll diameter setting	R/W	0.0% (0.0%~100.0%)	Unit-Specific Tension Parameter.
0x310D	Linear speed setting	R/W	0.0% (0.0%~100.0%)	Unit-Specific Tension Parameter.
0x310E	Acceleration time 1	R/W	0.00s (0.00s~600.00s)	Reads and writes the value of F01.22.
0x310F	Deceleration time 1	R/W	0.00s (0.00s~600.00s)	Reads and writes the value of F01.23.
0x3110	Fault warning & warning code	R	0 (0~65535)	1-127 are fault codes, 128-159 are warning codes, and 0 indicates no fault.
0x3111	Torque current component	R	0.0% (0.0%~400.0%)	An application parameter exclusive to belt machine.
0x3112	Torque filter time	R/W	0.000s (0.000s~6.000s)	Reads and writes the value of F03.47.
0x3113	Reserved	R/W	--	Use with option cards.
0x3114	Reserved	R/W	--	Use with option cards.
0x3115	Reserved	R/W	--	Use with option cards.
0x3116	Reserved	R/W	--	Use with option cards.
0x3117	Reserved	R/W	--	Use with option cards.
0x3118	Terminal output control	W	Binary	For output terminal function, set F06.21 - F06.24 to 30 [Communication control output]. Bit0: Y terminal Bit1: Relay Bit2: Expanded Y1 Bit3: Expanded relay
0x3119	AO output	W	0.01 (0~100.00)	F06.01 = 18 [AO function output selection = Set via RS485 communication].
0x311A	Expanded AO output	W	0.01 (0~100.00)	F06.11 = 18 [Expanded AO function output selection = Set via RS485 communication].
0x311B	Custom 1	R/W	0 (0~65535)	Used with an option card.
0x311C	Custom 2	R/W	0 (0~65535)	Used with an option card.
0x311D	Custom 3	R/W	0 (0~65535)	Used with an option card.
0x311E	Custom 4	R/W	0 (0~65535)	Used with an option card.
0x311F	Custom 5	R/W	0 (0~65535)	Used with an option card.

Input/Output Interface Communication Group (Address 0x34xx)

Communication Address	Name	Read/Write (R/W)	Dimension (Range)	Description
0x3400	Extension port SPI communication mode	R	0 (0~65535)	The default is 1 for AC310 series drive.
0x3401	Input terminal status	R	Binary	Bit0: X1 Terminal 0-OFF 1-ON

				Bit1: X2 Terminal 0-OFF 1-ON Bit2: X3 Terminal 0-OFF 1-ON Bit3: X4 Terminal 0-OFF 1-ON Bit4: X5 Terminal 0-OFF 1-ON Bit5: X6 Terminal 0-OFF 1-ON Bit6: X7 Terminal 0-OFF 1-ON Bit7: X8 Terminal 0-OFF 1-ON Bit8: X9 Terminal 0-OFF 1-ON Bit9: X10 Terminal 0-OFF 1-ON
0x3402	Output terminal status	R	Binary	Bit0: Y terminal status 0-OFF 1-ON Bit1: Relay status 0-OFF 1-ON Bit2: Expanded Y1 status 0-OFF 1-ON Bit3: Expanded relay status 0-OFF 1-ON
0x3403	Reserved	R	--	--
0x3404	Reserved	R/W	--	--
0x3405	Multi-function input terminal functional group 0	R	Binary	For multi-function 0-15, each function corresponds to one bit. 0-OFF 1-ON
0x3406	Multi-function input terminal function group 1	R	Binary	For multi-function 16-31, each function corresponds to one bit. 0-OFF 1-ON
0x3407	Multi-function input terminal function group 2	R	Binary	For multi-function 32-47, each function corresponds to one bit. 0-OFF 1-ON
0x3408	Multi-function input terminal function group 3	R	Binary	For multi-function 48-63, each function corresponds to one bit. 0-OFF 1-ON
0x3409	Multi-function input terminal function group 4	R	Binary	For multi-function 64-79, each function corresponds to one bit. 0-OFF 1-ON
0x340A	Multi-function input terminal function group 5	R	Binary	For multi-function 80-95, each function corresponds to one bit. 0-OFF 1-ON
0x340B	IO extension card input terminal status	R	Binary	Bit0: X6 Terminal 0-OFF 1-ON Bit1: X7 Terminal 0-OFF 1-ON Bit2: X8 Terminal 0-OFF 1-ON Bit3: X9 Terminal 0-OFF 1-ON Bit4: X10 Terminal 0-OFF 1-ON Bit5 - Bit11 Reserved Bit12 - Bit15 correspond to 4-bit virtual terminal signals 0-OFF 1-ON

0x340C	IO extension card output terminal status	R	Binary	Bit0: Expanded Y1 status 0-OFF 1-ON Bit1: Expanded relay status 0-OFF 1-ON
0x340D	IO extension card analog 1	R	0.00% (0.00%~100.00%)	IO extension Card Analog Detection (Motor Temperature Detection).
0x340E	IO extension card analog 2	R	--	Reserved.
0x340F	IO extension card analog 3	R	--	Reserved.
0x3410	IO extension card analog 4	R	--	Reserved.
0x3411	IO extension card PUL frequency measurement 1	R	0 (0~65535)	extension Card PUL Frequency Measurement Value = PUL frequency measurement 1 + PUL frequency measurement 2*65535.
0x3412	IO extension card PUL frequency measurement 2	R	0 (0~65535)	
0x3413	Reserved	R/W	--	--
0x3414	A0 function 24 output	R/W	0 (0~1000)	Used with an option card.
0x3415	A0 function 25 output	R/W	0 (0~1000)	Used with an option card.
0x3416	A0 function 26 output	R/W	0 (0~1000)	Used with an option card.
0x3417	A0 function 27 output	R/W	0 (0~1000)	Used with an option card.
0x3418	A0 function 28 output	R/W	0 (0~1000)	Used with an option card.
0x3419	A0 function 29 output	R/W	0 (0~1000)	Used with an option card.
0x341A	A0 function 30 output	R/W	0 (0~1000)	Used with an option card.
0x341B	A0 function 31 output	R/W	0 (0~1000)	Used with an option card.
0x341C	IO extension card PUL port count 1	R	0 (0~65535)	Used with an option card.
0x341D	IO extension card PUL port count 2	R	0 (0~65535)	Used with an option card.
0x341E	Reserved	R/W	--	--
0x341F	Reserved	R/W	--	--

Cache Register Communication Group (Address 0x35xx)

Communication Address	Name	Read/Write (R/W)	Dimension (Range)	Description
0x3500	Register 0	R/W	(0~65535)	Used with an option card.
0x3501	Register 1	R/W	(0~65535)	Used with an option card.
0x3502	Register 2	R/W	(0~65535)	Used with an option card.
0x3503	Register 3	R/W	(0~65535)	Used with an option card.
0x3504	Register 4	R/W	(0~65535)	Used with an option card.
0x3505	Register 5	R/W	(0~65535)	Used with an option card.
0x3506	Register 6	R/W	(0~65535)	Used with an option card.
0x3507	Register 7	R/W	(0~65535)	Used with an option card.
0x3508	Register 8	R/W	(0~65535)	Used with an option card.

0x3509	Register 9	R/W	(0~65535)	Used with an option card.
0x350A	Register 10	R/W	(0~65535)	Used with an option card.
0x350B	Register 11	R/W	(0~65535)	Used with an option card.
0x350C	Register 12	R/W	(0~65535)	Used with an option card.
0x350D	Register 13	R/W	(0~65535)	Used with an option card.
0x350E	Register 14	R/W	(0~65535)	Used with an option card.
0x350F	Register 15	R/W	(0~65535)	Used with an option card.

Extension Fault and Power-Off Parameter Communication Group (Address 0x36xx)

Communication Address	Name	Read/Write (R/W)	Dimension (Range)	Description
0x3600	Custom fault number register	R/W	0 (11~18)	11-18 correspond to faults E. FA1-E. FA8.
0x3601	Custom early-warning number register	R/W	0 (11~16)	11 to 16 correspond to warnings A. FA1-A. FA6.
0x3602	Reserved	R/W	--	--
0x3603	Reserved	R/W	--	--
0x3604	Reserved	R/W	--	--
0x3605	Reserved	R/W	--	--
0x3606	Reserved	R/W	--	--
0x3607	Reserved	R/W	--	--
0x3608	Reserved	R/W	--	--
0x3609	Reserved	R/W	--	--
0x360A	Stored parameter 1 after power-off	R/W	(0~65535)	Used with an option card. Check with C02.32.
0x360B	Stored parameter 2 after power-off	R/W	(0~65535)	Used with an option card. Check with C02.33.
0x360C	Stored parameter 3 after power-off	R/W	(0~65535)	Used with an option card. Check with C02.34.
0x360D	Stored parameter 4 after power-off	R/W	(0~65535)	Used with an option card. Check with C02.35.
0x360E	Stored parameter 5 after power-off	R/W	(0~65535)	Used with an option card. Check with C02.36.
0x360F	Stored parameter 1 after power-off	R/W	(0~65535)	Used with an option card. Check with C02.37.
0x3610	Stored parameter 6 after power-off	R/W	(0~65535)	Used with an option card. Check with C02.38.
0x3611	Stored parameter 7 after power-off	R/W	(0~65535)	Used with an option card. Check with C02.39.
0x3612	Stored parameter 8 after power-off	R/W	(0~65535)	Used with an option card. Check with C02.40.

0x3613	Stored parameter 9 after power-off	R/W	(0~65535)	Used with an option card. Check with C02.41.
0x3614	Stored parameter 10 after power-off	R/W	(0~65535)	Used with an option card. Check with C02.42.
0x3615	Stored parameter 11 after power-off	R/W	(0~65535)	Used with an option card. Check with C02.43.
0x3616	Stored parameter 12 after power-off	R/W	(0~65535)	Used with an option card. Check with C02.44.
0x3617	Stored parameter 13 after power-off	R/W	(0~65535)	Used with an option card. Check with C02.45.
0x3618	Stored parameter 14 after power-off	R/W	(0~65535)	Used with an option card. Check with C02.46.
0x3619	Stored parameter 15 after power-off	R/W	(0~65535)	Used with an option card. Check with C02.47.
0x361A	Reserved	R/W	--	-
0x361B	Reserved	R/W	--	--
0x361C	Reserved	R/W	--	-
0x361D	Reserved	R/W	--	--
0x361E	Reserved	R/W	--	-
0x361F	Reserved	R/W	--	--

11 Parameter Details

11.1 Safety Precautions

Danger
<p>Please follow all the safety instructions in this manual.</p> <p>Failure to follow the precautions may result in death or serious injury. Please be cautious. We will not take any responsibility for personal injuries and equipment damages caused by your company or your customers due to not complying with the contents of this Manual.</p>

11.2 Group F00: Environmental Application

Group F00 parameters [Environment application] are used to set items related to the operating environment of the drive.

Group F00.0x: Environment Settings

Group F00 parameters are used to set the operating environment and operating conditions for frequency conversion. Examples are parameter access levels, purpose selection and other items.

✧ F00.00: Parameter Access Level

Parameter Code (Address)	Name	Description	Default (Range)
F00.00 (0x0000) RUN	Parameter access level	V/F SVC FVC PMVF PMSVC PMFVC Set the parameter access level according to the parameter access limitations.	0 (0~3)

0: Standard Parameter

Allows access to parameter groups (Fxx groups) and monitoring parameter (Cxx groups).

1: Common parameter (F00.00, Pxx.yy)

Allows access only to the parameter codes set in F00.00 parameters and F00.10 - F00.39 [Common parameters 1-30].

2: Monitoring parameter (F00.00, Cxx.yy)

Allows access only to F00.00 parameters and monitoring group parameters.

3: Parameter changed (F00.00, Hxx.yy)

Allows access only to F00.00 parameters, and parameters different from the Defaults.

Note:

When a lock password has been set for the drive with F11.00 [Key lock selection] and F11.01 [Key lock password], the Keypad cannot be used to change the corresponding parameters.

✧ F00.01: Purpose Selection

Parameter Code (Address)	Name	Description	Default (Range)
F00.01 (0x0001) STOP	Use selection	V/F SVC FVC PMVF PMSVC PMFVC Set the drive for the intended use.	0 (0~1)

This drive has the special preset settings for the uses as shown in the table below. After F00.01 is set for the intended use, the drive will automatically set the parameters related to the use to the optimal values. Parameters to be changed frequently are saved in F00.10 - F00.39 [Common parameters 1-30] for quick setting and viewing.

0: General purpose unit (G model)

1: Fan and water pump model (P model)

Note:

After setting F00.01, initialize the parameters with F00.03 = 11, 22 [Initialization = Initialization mode 1, 2]. F00.30 - F00.39 will be reset after the parameterization and initialization.

The following are values of commonly used parameter codes after initialization.

Table 11.1: Values of commonly used parameter codes after initialization

Common Parameter Code	Set Point	Parameter Code Corresponding To Set Point	Name
F00.10	0100	F01.00	Control mode selection.
F00.11	0101	F01.01	Run command given channel.
F00.12	0102	F01.02	Frequency given channel.
F00.13	0710	F07.10	Stop mode.
F00.14	0122	F01.22	Acceleration time 1.
F00.15	0123	F01.23	Deceleration time 1.
F00.16	0110	F01.10	Maximum frequency.
F00.17	0112	F01.12	Upper frequency limit.
F00.18	0140	F01.40	Carrier frequency.
F00.19	0730	F07.30	Jogging frequency.
F00.20	0201	F02.01	Poles of motor.
F00.21	0202	F02.02	Rated power of motor.
F00.22	0203	F02.03	Rated frequency of motor.
F00.23	0204	F02.04	Rated speed of motor.
F00.24	0205	F02.05	Rated voltage of motor.
F00.25	0206	F02.06	Rated current of motor.
F00.26	0207	F02.07	Selection of motor parameter Auto-tuning.
F00.27	1201	F12.01	Modbus communication address.
F00.28	1202	F12.02	Communication baud rate.
F00.29	1203	F12.03	Communication data format.

The values of the following common parameter codes after initialization are related to the F00.01 setting.

0: General purpose unit (G model)

Table 11.2: Values of commonly used parameter codes after initialization

Common Parameter Code	Set Point	Parameter Code Corresponding To Set Point	Name
F00.30	0700	F07.00	Startup mode.
F00.31	0705	F07.05	Rotation direction selection.
F00.32	0502	F05.02	X3 terminal function selection.
F00.33	0503	F05.03	X4 terminal function selection.
F00.34	0504	F05.04	X5 terminal function selection.
F00.35	0601	F06.01	AO output selection.
F00.36	0600	F06.00	AO output mode selection.
F00.37	0621	F06.21	Output terminal y function selection.
F00.38	0622	F06.22	TA-TB-TC output function selection.
F00.39	0400	F04.00	V/f curve.

1: Fan and water pump model (P model)

Table 11.3: Values of commonly used parameter codes after initialization

Common Parameter Code	Set Point	Parameter Code Corresponding to Set Point	Name
F00.30	0700	F07.00	Startup mode.
F00.31	0705	F07.05	Rotation direction selection.
F00.32	0400	F04.00	V/F curve.
F00.33	1050	F10.50	Number of retries after fault.
F00.34	1300	F13.00	PID setting.
F00.35	1303	F13.03	PID feedback.
F00.36	1307	F13.07	PID control selection.
F00.37	1311	F13.11	PID proportional gain P1.
F00.38	1325	F13.25	PID feedback disconnection selection.
F00.39	1329	F13.29	Sleep selection.

◇ **F00.03: Initialization**

Parameter Code (Address)	Name	Description	Default (Range)
F00.03 (0x0003) STOP	Initialization	V/F SVC FVC PMVF PMSVC PMFVC Sets the initialization mode of the drive.	0 (0~33)

Note: The value of F00.03 automatically returns to zero after initialization.

0: No initialization.

11: Initialization Mode 1

Restores all parameters except F02.01 - F02.06 [Basic motor parameters], F02.10 - F02.29 [Advanced motor parameters] and parameters that cannot be initialized.

22: Initialization Mode 2

Recovers all parameters except those that cannot be initialized.

33: Clear fault records

Clears all historical fault information recorded in monitoring parameter group C01.

The following parameters will not be initialized even if F00.03 = 11 or 22.

Parameter Code	Name
F00.10~F00.29	Common parameters 1-20.
F00.01	Purpose selection.
F07.05	Rotation direction selection.
F11.05	Parameter code setting quick change with up/down key.
F11.11~F11.18	Parameters displayed repeatedly in keypad status screen.
F12.11~F12.16	RS485 custom address setting.

Note:

➤ F00.03 = 11 or 22. F00.30 - F00.39 are set to different values after initialization according to F00.01 [Purpose selection].

◇ **F00.04: Keypad Parameter Copy**

Parameter Code (Address)	Name	Description	Default (Range)
--------------------------	------	-------------	-----------------

F00.04 (0x0004) STOP	Keypad parameter copy	V/F SVC FVC PMVF PMSVC PMFVC Saves the parameters of the drive into the keypad for copying them to another drive later.	0 (0~30)
----------------------------	--------------------------	---	-------------

0: No action

11: Upload parameters to the keypad

Reads the set values of parameters from the drive and save them into the Keypad.

22: Download parameters to the drive

Copies the set values of parameters saved in the Keypad to another drive.

The action mode will be displayed on the Keypad when the parameter values are being copied.

Keypad display	Name
CoPy	Uploads parameters to the Keypad.
LoAd	Downloads the parameters to the drive.

If a fault is detected, the fault will be displayed on the keypad when the parameter values are being copied.

Code	Name	Cause	Countermeasures
A.CoP	Parameter copy abnormality alarm	Abnormal communication occurs during the copying process.	Check or replace the Keypad cable.

◇ **F00.07 - F00.08: Arbitrary Parameters**

Parameter Code (Address)	Name	Description	Default (Range)
F00.07 (0x0007) RUN	Free parameter 1	V/F SVC FVC PMVF PMSVC PMFVC You may enter any value as a flag.	0 (0~65535)
F00.08 (0x0008) RUN	Free parameter 2	V/F SVC FVC PMVF PMSVC PMFVC You may enter any value as a flag.	0 (0~65535)

Note: Arbitrary parameters will not affect the motion of drive.

For example:

- Serves as the unit number when multiple units are used.
- Serves as the mode number for each use when multiple units are used.
- Dates of purchase, check, etc.

Group F00.1x: Common Parameter Settings

◇ F00.10~F00.39: Common Parameters 1-30

Parameter Code (Address)	Name	Description	Default (Range)
F00.10~F00.29 (0x000A~0x001D) RUN	Common parameters 1-20	V/F SVC FVC PMVF PMSVC PMFVC It is possible to register 20 commonly used parameters in F00.10 - F00.29, and the registered parameters can be accessed quickly by setting F00.00 [Parameter access level].	General Default Parameters (0000-2999)
F00.30~F00.39 (0x001E~0x0027) RUN	Common parameters 21-30	V/F SVC FVC PMVF PMSVC PMFVC It is possible to register 10 commonly used parameters in F00.30 - F00.39, and the registered parameters can be accessed quickly by setting F00.00 [Parameter access level].	Depending on F00.01 (0000-2999)

Note:

- F00.03 = 11 or 22. F00.30 - F00.39 are set to different values after initialization according to F00.01 [Purpose selection].
- Common parameters can be accessed quickly by setting F00.00=1 [Parameter access level = Common parameters].

11.3 Group F01: Basic Settings

Group F01.0x: Basic Commands

Group F01.0x parameters are used to set the control mode, run command source and frequency setting source.

Control Mode

◇ F01.00: Control Mode

Parameter Code (Address)	Name	Description	Default (Range)
F01.00 (0x0100) STOP	Control mode	V/F SVC FVC PMVF PMSVC PMFVC Selects the control mode according to the type and intended use of the motor.	0 (0~20)

Selects the control mode according to the type and intended use of the motor.

0: Asynchronous Motor V/F Control (V/F)

This control mode is used for variable speed control that do not require fast response or accurate speed control, and in scenarios where one drive is used with multiple motors. This mode is also used when the motor parameters are not clear or Auto-tuning cannot be performed.

1: Asynchronous Motor Open-Loop Vector Control (SVC)

This control mode is used for applications requiring high speed control accuracy. With high speed response and torque response, high torque can be output even under low-speed running.

2: Asynchronous Motor Closed-Loop Vector Control (FVC)

This control mode is used in scenarios requiring fast torque response and high-precision speed control before zero speed is reached. Feedback signals from motor speed is required.

10: Synchronous Motor V/F control (PMV/F)

This control mode is used for variable speed control of synchronous motors that do not require fast response or accurate speed control.

11: Synchronous Motor Open-Loop Vector Control (PMSVC)

This control mode is used for applications that require precise speed control and torque limit functions.

12: Synchronous Motor Closed-Loop Vector Control (PMFVC)

This control mode is used for constant torque applications requiring high-precision control when using PM motors, and variable speed control requiring fast torque response and high-performance torque control. Speed feedback from the motor is required.

20: Voltage-Frequency separation Control (VF_separation)

This control mode is used to control the output voltage and frequency separately. (Valid only for T3 models of 7.5 kW or above and T2 models of 5.5 kW and above).

Note:

- In order to obtain the best control effect, please input the correct motor parameters and perform motor Auto-tuning. Group F02.0x is the basic parameter group of the motor.
- In open-loop and closed-loop vector control, the drive can only drive one motor; and there shall not be too large discrepancy between the level of drive capacity and that of motor capacity. The power level of drive can be two levels higher or one level lower than that of the motor, otherwise it may cause degraded control performance or failure of drive system.

Run Command Source

✧ F01.01: Run Command Channel

Parameter Code (Address)	Name	Description	Default (Range)
F01.01 (0x0101) RUN	Run command channel	V/F SVC FVC PMVF PMSVC PMFVC Selects the input method for run commands.	0 (0~3)

0: Keypad

Uses the Keypad to control the operation and stop of the drive.

The functions of multi-function keys can be set with F11.02 = 1, 2, 3 [Keypad multi-function key selection = reverse rotation, forward jogging, reverse jogging] to control the reverse rotation, forward jogging and reverse jogging of the drive.

1: Terminal Control

Controls the operation and stop of the drive with the terminals on the control board. The input method of run commands is selected with parameters. Please set F05.20 = 0-3 [Terminal controlled operation mode = 2-wire system 1, 2; 3-wire system 1, 2].

2: RS485 Communication

Run commands are input via RS485 communication.

3: Option card

An optional communication card or input card plugged into the drive is used to input run commands.

Refer to the instructions supplied together with the option cards for information on the installation and relevant settings of the option cards.

3: Terminal switching command given

Command Input Mode		Priority	Description
Jogging	Jogging with keypad	2	Effective when the run command channel is Keypad.
	Jogging via RS485 communication	2	Effective when the run command channel is RS485 communication.
	Jogging with option card	2	Effective when the run command channel is option card.
	Jogging with terminals	3	Effective with any channel.
Run command channel		1	Set with parameter F01.01.

Table 11.4: Command input selection mode

Note: The higher the priority value, the higher the priority.

Frequency Setting

The input method, selection and priority of frequency commands are explained.

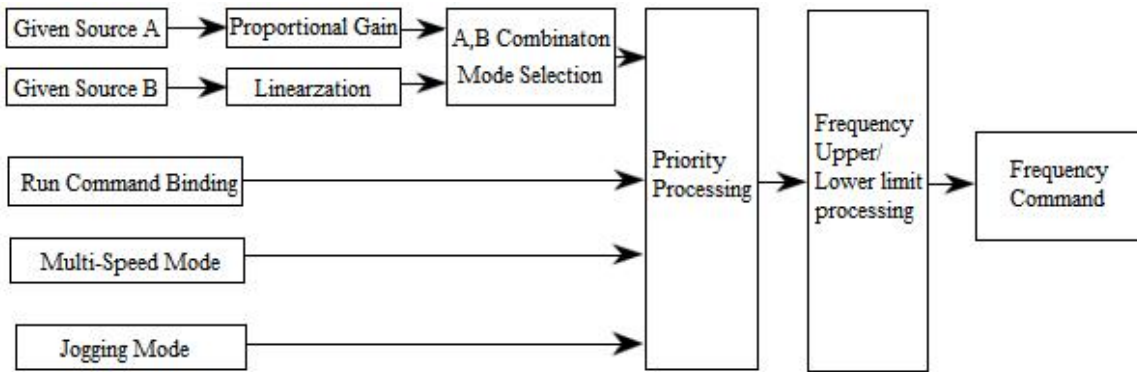

Diagram of Frequency Command Setting

Table 11.5: Frequency input selection mode

Frequency Input Mode		Priority	Description
Given source mode	Given source A	1	Input from given source A. The related parameters are F01.02 and F01.03.
	Given source B	1	Input from given source B. The related parameters are F01.04, F01.05 and F01.06.
	Given sources A and B	1	With F01.07, given sources A and B are combined to set the frequency.
Mode of frequency setting with run command binding		2	Bound frequency setting with command channel set with F01.08.
Multi-speed mode		3	The frequency is set by setting the multi-function terminal to multi-speed selection.
Jogging mode		4	When the jogging command is effective, the jogging frequency is set with F07.30.

Note:

1. The higher the priority value, the higher the priority.
2. The priority of the multi-speed mode is that shown in the table above only when there is no multi-speed selection among the setting source modes.
3. The priority of the multi-speed selection mode is the same as that of other modes among the set sources when multi-speed selection exists among the setting source modes.

Methods for modes of frequency setting sources A and B and frequency setting with run command binding:

Input method for frequency setting sources	Description
Set with keypad digital	The set point of F01.09 is set as the frequency.
Set with keypad potentiometer	This method is used when an outer single-line Keypad is used. The linearized values of 0% - 100% of the potentiometer correspond to 0 Hz - maximum frequency.
Set with AI1	Linearized values of 0% - 100% of the AI1 input corresponds to 0 Hz - maximum frequency.
Set with AI2	Linearized values of 0% - 100% of the AI2 input corresponds to 0 Hz - maximum frequency.
Terminal pulse PUL	Linearized values of 0% - 100% of the PUL input corresponds to 0 Hz - maximum frequency.
RS485 communication	The value is written to the address 0x3000 via RS485 communication to set the frequency value.
Terminal up/down button control	F05.25 and F05.26 are used to set the control mode of the up and down keys of terminals and the increase and decrease rates.
PID control	The values of 0% - 100% of process PID control output of group F13 correspond to 0 Hz - maximum frequency.
PLC program control	The frequency of each stage in group F14 group program control is used as the set frequency.
Option card	The set frequency value is obtained via communication with an option card.
Multi-speed	The frequency of the corresponding stage is determined to be the set frequency by setting the multi-function terminal to multi-speed.

Note:

1. Refer to the instructions of the option card for details on the option card's communication address for setting frequency.
2. The reference value of frequency setting source B is selected with F01.06 = 0, 1 [Reference value of frequency setting source B = Maximum frequency, setting source A]
3. The maximum frequency is set with F01.10.

Multi-Speed Operation:

The drive supports multi-speed operation, and multiple frequency commands can be preset as necessary. A number of frequency command values can be set in parameters F14.00 to F14.14, and the frequency setting command is selected in combination with multi-function input signals from the outside. The frequency command required for ON/OFF selection of connector input can be used to change the motor speed by stage. It is possible to have 17 speeds with 16 stages of frequency commands and 1 jogging frequency command (JOG command).

The combinations of multi-speed commands are shown in the table below.

Table 11.6 Combinations of Multi-Speed Commands and Multi-Function Connector Input Terminals

Related Parameters	Multi-Speed Terminal 1 F05.0x = 16	Multi-Speed Terminal 2 F05.0x = 17	Multi-Speed Terminal 3 F05.0x = 18	Multi-Speed Terminal 4 F05.0x = 19	Jogging Terminal F05.0x = 4/5
F01.09 Set with keypad digital	OFF	OFF	OFF	OFF	OFF
F14.00 Multi-Speed 1	ON	OFF	OFF	OFF	OFF
F14.01 Multi-Speed 2	OFF	ON	OFF	OFF	OFF
F14.02 Multi-Speed 3	ON	ON	OFF	OFF	OFF
F14.03 Multi-Speed 4	OFF	OFF	ON	OFF	OFF
F14.04 Multi-Speed 5	ON	OFF	ON	OFF	OFF
F14.05 Multi-Speed 6	OFF	ON	ON	OFF	OFF
F14.06 Multi-Speed 7	ON	ON	ON	OFF	OFF
F14.07 Multi-Speed 8	OFF	OFF	OFF	ON	OFF
F14.08 Multi-Speed 9	ON	OFF	OFF	ON	OFF
F14.09 Multi-Speed 10	OFF	ON	OFF	ON	OFF
F14.10 Multi-Speed 11	ON	ON	OFF	ON	OFF
F14.11 Multi-Speed 12	OFF	OFF	ON	ON	OFF

F14.12 Multi-Speed 13	ON	OFF	ON	ON	OFF
F14.13 Multi-Speed 14	OFF	ON	ON	ON	OFF
F14.14 Multi-Speed 15	ON	ON	ON	ON	OFF
F07.30 Jogging Frequency	-	-	-	-	ON

◇ **F01.02 - F01.03: Frequency given source channel A**

Parameter Code (Address)	Name	Description	Default (Range)
F01.02 (0x0102) RUN	Frequency given source channel A	V/F SVC FVC PMVF PMSVC PMFVC Selects the input mode for frequency setting.	0 (0~11)
F01.03 (0x0103) STOP	Gain of frequency given source channel A	V/F SVC FVC PMVF PMSVC PMFVC Performs proportional gain processing on the value input from setting source A.	100.0% (0.0%~500.0%)

Frequency given source channel A Output Mode:

- 0: Keypad digital
- 1: Keypad potentiometer (optional outer single-line keypad)
- 2: Current/voltage analog AI1
- 3: Current/voltage analog AI2
- 4: Reserved
- 5: Terminal pulse PUL
- 6: RS485 communication
- 7: Terminal UP/DW control
- 8: PID control
- 9: Program control (PLC)
- 10: Option card
- 11: Multi-speed

◇ F01.04 - F01.06: Frequency given source channel B

Parameter Code (Address)	Name	Description	Default (Range)
F01.04 (0x0102) RUN	Frequency given source channel B	V/F SVC FVC PMVF PMSVC PMFVC Selects the input mode for frequency setting.	2 (0~11)
F01.05 (0x0103) STOP	Gain of frequency given source channel B	V/F SVC FVC PMVF PMSVC PMFVC Performs proportional gain processing on the value input from setting source B.	100.0% (0.0%~500.0%)
F01.06 (0x0106) RUN	Frequency given source B reference value	V/F SVC FVC PMVF PMSVC PMFVC The value input from setting source B is linearized, and the input value is the value corresponding to 100%.	0 (0~1)

Frequency given source channel B Output Mode:

- 0: Keypad digital
- 1: Keypad potentiometer (optional outer single-line keypad)
- 2: Current/voltage analog AI1
- 3: Current/voltage analog AI2
- 4: Reserved
- 5: Terminal pulse PUL
- 6: RS485 communication
- 7: Terminal UP/DW control
- 8: PID control
- 9: Program control (PLC)
- 10: Option card
- 11: Multi-speed

Frequency given source channel B Reference Value:

- 0: F01.10 [Maximum frequency] as reference source
- 1: Frequency set with frequency given source A as the reference source

◇ F01.07: Frequency given source selection

Parameter Code (Address)	Name	Description	Default (Range)
F01.07 (0x0107) RUN	Frequency given source selection	V/F SVC FVC PMVF PMSVC PMFVC Sets the combination of frequency set sources A and B.	0 (0~5)

0: Frequency given source A**1: Frequency given source B****2: Sum of frequency given source A and frequency given source B****3: Difference between frequency given source A and frequency given source B (A - B)****4: Frequency given source A or frequency given source B, whichever the larger****5: Frequency given source A or frequency given source B, whichever the smaller****Note:**

- The value of the combination is subject to the upper and lower frequency limits.

- If the LED"00" of F07.05 = 1 [Running direction = Only forward command is allowed] or the LED"000" of F07.05 = 0 [Frequency control command direction = Invalid], 0.00 Hz is used as the set frequency of the drive when the calculation result of combination is negative.

✧ **F01.08: Frequency Given with Run Command Binding**

Parameter Code (Address)	Name	Description	Default (Range)
F01.08 (0x0108) RUN	Frequency given with run command binding	V/F SVC FVC PMVF PMSVC PMFVC Sets the method for frequency setting with run command binding.	0000 (0000~DDDD)

Note: The set point is expressed in hexadecimal. Each of the places of LED"0",LED"00", LED"000" and LED"0000" has a different meaning.

- 0: No binding
- 1: Keypad digital
- 2: Keypad potentiometer (optional outer single-line keypad)
- 3: Current/voltage analog AI1
- 4: Current/voltage analog AI2
- 5: Reserved
- 6: Terminal pulse PUL
- 7: RS485 communication
- 8: Terminal UP/DW control
- 9: PID control
- A: Program control (PLC)
- B: Option card
- C: Multi-speed
- D: Reserved

LED"0": Keypad command binding

LED"00": Terminal command binding

LED"000": Communication instruction command binding

LED"0000": Option card instruction command binding

In an example of frequency setting with run command binding, remote/local switching is used. For the remote mode, setting via communication commands and frequency setting are used; for the local mode, setting with terminal commands and keypad digital are used. Just switch the command setting method with the terminal, and then set the mode of frequency setting with run command binding for different channels.

✧ **F01.09: Keypad Number Set Frequency**

Parameter Code (Address)	Name	Description	Default (Range)
F01.09 (0x0109) RUN	Keypad number set frequency	V/F SVC FVC PMVF PMSVC PMFVC Sets frequency setting with keypad digital.	50.00Hz (0.00Hz~F01.12)

Note:

- This parameter is effective when F01.02 = 0 [Frequency setting source A = Set with keypad digital] or F01.04 = 0 [Frequency setting source B = Set with keypad digital].

Group F01.1x: Upper and Lower Frequency Limits

Group F01.1x parameters are used to set the upper and lower limits of frequency commands to limit the speed of motor. For example, they may be used when high-speed operation is not desired due to mechanical strength, or when low-speed operation is not desired due to lubrication of gears, bearings, etc.

The upper limit value of frequency is selected with F01.11 [Upper frequency limit setting mode selection], and the lower limit value is set with F01.13 [Lower frequency limit].

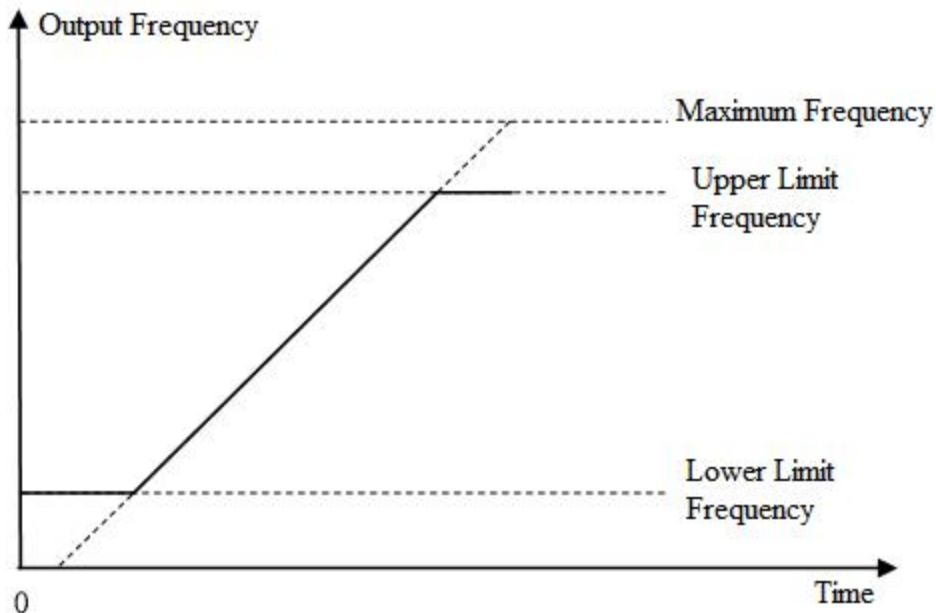

Diagram of Relationship between Maximum Frequency, Upper Frequency Limit and Lower Frequency Limit

◇ F01.10: Maximum Frequency

Parameter Code (Address)	Name	Description	Default (Range)
F01.10 (0x010A) STOP	Maximum frequency	V/F SVC FVC PMVF PMSVC PMFVC Sets the maximum frequency value.	50.00 Hz (Upper frequency limit - 500.00 Hz)

The maximum frequency is used as the reference corresponding to 100.0% when analog input, pulse input (PUL), PID control output and other numerical values in the drive are converted into frequency;

The maximum frequency is used as the reference frequency for acceleration/deceleration time (F01.20 = 0 [Acceleration/Deceleration time reference frequency = Maximum frequency]).

◇ F01.11 - F01.12: Upper Frequency Limit

Parameter Code (Address)	Name	Description	Default (Range)
F01.11 (0x010B) RUN	Upper Frequency Limit Setting Mode Selection	V/F SVC FVC PMVF PMSVC PMFVC Upper Frequency Limit Setting Mode Selection.	0 (0~7)
F01.12 (0x010C) RUN	Upper frequency limit setting with numbers	V/F SVC FVC PMVF PMSVC PMFVC Sets the upper frequency limit value.	50.00 Hz (Lower frequency limit - F01.10)

The upper frequency limit sets the maximum value of the calculated frequency of a frequency setting source. If the calculated frequency is greater than the upper frequency limit, the upper frequency limit is taken as the set frequency.

0: Sets Upper Frequency Limit with Numbers

1: Keypad potentiometer (optional outer single-line Keypad)

2: Current/voltage analog AI1

3: Current/voltage analog AI2

4: Reserved

5: Terminal pulse PUL

6: RS485 communication

7: Option card

◇ F01.13: Lower Frequency Limit

Parameter Code (Address)	Name	Description	Default (Range)
F01.13 (0x010D) RUN	Lower Frequency Limit	V/F SVC FVC PMVF PMSVC PMFVC Sets the lower frequency limit value.	0.00 Hz (0.00 Hz - upper frequency limit)

The lower frequency limit sets the minimum value of the calculated frequency of a frequency setting source. If the calculated frequency is smaller than the lower frequency limit, the lower frequency limit is taken as the set frequency.

Note:

- The jogging frequency setting is not subject to the lower frequency limit.

◇ F01.14: Frequency Command Resolution

Parameter Code (Address)	Name	Description	Default (Range)
F01.14 (0x010E) STOP	Frequency Command Resolution	V/F SVC FVC PMVF PMSVC PMFVC Sets the resolution of frequency commands.	0 (0~3)

Resolution options:

0: 0.01Hz

1: 0.1Hz

2: 0.1rpm

3: 1rpm

Note:

- After the frequency command resolution is switched, the function code resolution related to frequency will also be switched.

Group F01.2x~F01.3x: Acceleration/Deceleration Time

Acceleration/Deceleration Time 1 - 4

Up to 4 pairs of acceleration/deceleration time can be set for the product. The acceleration/deceleration time may be switched even during operation by turning ON/OFF the multi-function input terminals for which Acceleration/Deceleration Time Selection 1 and Acceleration/Deceleration Time Selection 2 has been set.

Sets the acceleration time of the output frequency from 0Hz to the reference frequency for acceleration/deceleration time. Sets the deceleration time of the output frequency from the reference frequency for acceleration/deceleration time to 0Hz.

F01.22 [Acceleration Time 1] and F01.23 [Deceleration Time 1] are Valid by default.

The reference frequency for acceleration/deceleration time is selected with F01.20 [Selection of reference frequency for acceleration/deceleration time]

F01.20 Set Point	Description
0	The maximum frequency is taken as the reference frequency.
1	The fixed frequency of 50.00 Hz is taken as the reference frequency.
2	The set frequency is taken as the reference frequency.

The setting range of acceleration/deceleration time is selected with F01.21 [Unit of acceleration/deceleration time]

Parameter	Set Range		
	F01.21 = 0	F01.21 = 1	F01.21 = 2
F01.22 [Acceleration Time 1]	0s~65000s	0.0s~6500.0s	0.00s~650.00s
F01.23 [Deceleration Time 1]			
F01.24 [Acceleration Time 2]			
F01.25 [Deceleration Time 2]			
F01.26 [Acceleration Time 3]			
F01.27 [Deceleration Time 3]			
F01.28 [Acceleration Time 4]			
F01.29 [Deceleration Time 4]			

The acceleration/deceleration time is switched with instructions of the multi-function input terminals

The combinations of acceleration/deceleration time switching are shown in the table below.

Table 11.7: Acceleration/Deceleration time switched with terminals

F05.0x = 32 Acceleration/Deceleration Time Selection 1	F05.0x = 33 Acceleration/Deceleration Time Selection 2	Acceleration/Deceleration Time Selection	
		Acceleration Time	Deceleration Time
OFF	OFF	F01.22 [Acceleration Time 1]	F01.23 [Deceleration Time 1]
ON	OFF	F01.24 [Acceleration Time 2]	F01.25 [Deceleration Time 2]
OFF	ON	F01.26 [Acceleration Time 3]	F01.27 [Deceleration Time 3]
ON	ON	F01.28 [Acceleration Time 4]	F01.29 [Deceleration Time 4]

An example of operation after changing the acceleration/deceleration time is shown in the figure below. In this example, F07.10 = 0 [Stop Method Selection = Deceleration to stop].

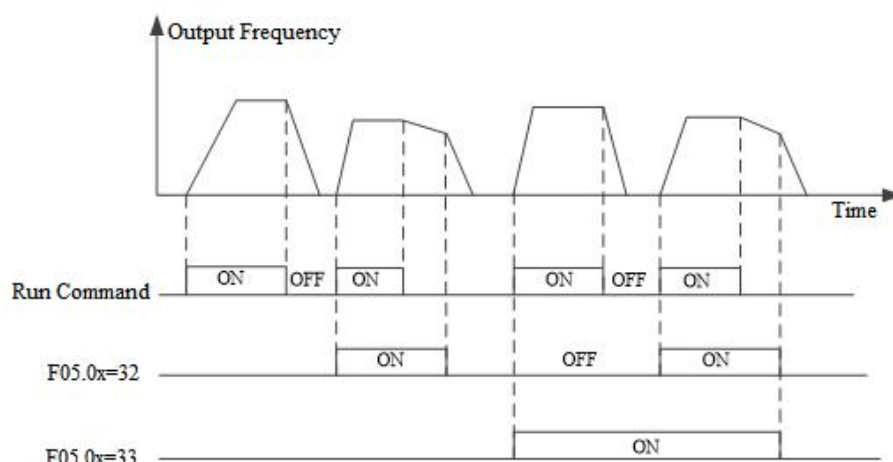

Time Sequence Diagram of Acceleration/Deceleration Time

The acceleration/deceleration time is switched with output frequency

The acceleration/deceleration time of the drive can be automatically switched according to the set output frequency. The acceleration/deceleration time of the drive is automatically switched when the output frequency reaches the set point of F01.35 [Acceleration/Deceleration Time Switching Frequency]. This function is disabled when F01.35 = 0.00 Hz.

Note:

The acceleration/deceleration time selection function set on the multi-function input takes precedence over the automatic acceleration/deceleration time switching function set with F01.35. For example, when the multi-function input terminal for acceleration/deceleration time selection 1 [F05.0x = 32] is set to ON, the drive only uses Acceleration/Deceleration Time 2, and the automatic switching function of acceleration/deceleration time with F01.35 is disabled.

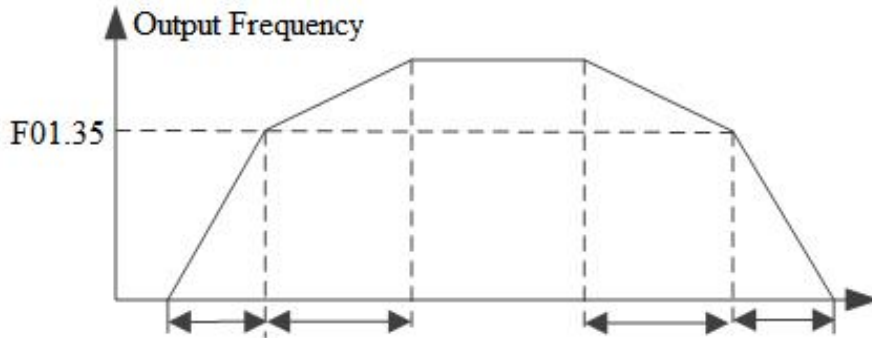

Note: Acceleration/Deceleration Time 1 is used when the output frequency is less than or equal to F01.35; Acceleration/Deceleration Time 2 is used when the output frequency is larger than or equal to F01.35.

◇ **F01.20: Reference Frequency for Acceleration/Deceleration Time**

Parameter Code (Address)	Name	Description	Default (Range)
F01.20 (0x0114) STOP	Reference frequency for acceleration/deceleration time	V/F SVC FVC PMVF PMSVC PMFVC Set the reference frequency for acceleration/deceleration time.	0 (0~3)

0: Maximum frequency The reference for acceleration/deceleration time is F01.10 [Maximum frequency].

1: Fixed frequency The reference for acceleration/deceleration time is fixed at 50.00 Hz.

2: Given frequency The reference for acceleration/deceleration time is the given frequency. Please note that the acceleration of the motor will change if the given frequency changes frequently.

◇ **F01.21: Acceleration/Deceleration Time Range Selection**

Parameter Code (Address)	Name	Description	Default (Range)
F01.21 (0x0115) STOP	Acceleration/Deceleration Time Range Selection	V/F SVC FVC PMVF PMSVC PMFVC Sets the decimal point of F01.22 - F01.29 [Acceleration/Deceleration time 1 to 4] parameters.	2 (0~2)

Note: The Default is 2, which means two decimal digits.

0: No decimal point

1: 1 decimal digit

2: 2 decimal digits

◇ F01.22: Acceleration Time 1

Parameter Code (Address)	Name	Description	Default (Range)
F01.22 (0x0116) RUN	Acceleration time 1	V/F SVC FVC PMVF PMSVC PMFVC Set the value of acceleration time 1.	Depending on power level (Changing with F01.21)

◇ F01.23: Deceleration Time 1

Parameter Code (Address)	Name	Description	Default (Range)
F01.23 (0x0117) RUN	Deceleration time 1	V/F SVC FVC PMVF PMSVC PMFVC Set the value of deceleration time 1.	Depending on power level (Changing with F01.21)

The relationship between the Default of acceleration/deceleration time and the power level of the drive is shown in the table below.

Drive Power	Defaults of Acceleration/Deceleration Time 1 - 4
<22kW	6.00s
<45kW	12.00s
<=55kW	18.00s
<=75kW	24.00s
<=90kW	30.00s
<=132kW	36.00s
<=160kW	42.00s
<185kW	48.00s
<220kW	54.00s
Others	60.00s

◇ F01.24~F01.25 Acceleration/Deceleration Time 2

Parameter Code (Address)	Name	Description	Default (Range)
F01.24 (0x0118) RUN	Acceleration time 2	V/F SVC FVC PMVF PMSVC PMFVC Set the value of acceleration time 2.	Depending on power level (Changing with F01.21)
F01.25 (0x0119) RUN	Deceleration time 2	V/F SVC FVC PMVF PMSVC PMFVC Set the value of deceleration time 2.	Depending on power level (Changing with F01.21)

◇ F01.26~F01.27 Acceleration/Deceleration Time 3

Parameter Code (Address)	Name	Description	Default (Range)
F01.26 (0x011A) RUN	Acceleration time 3	V/F SVC FVC PMVF PMSVC PMFVC Set the value of acceleration time 3.	Depending on power level (Changing with F01.21)
F01.27	Deceleration time 3	V/F SVC FVC PMVF PMSVC PMFVC	Depending on power

(0x011B) RUN		Set the value of deceleration time 3.	level (Changing with F01.21)
-----------------	--	---------------------------------------	---------------------------------

◇ F01.28~F01.29 Acceleration/Deceleration Time 4

Parameter Code (Address)	Name	Description	Default (Range)
F01.28 (0x011C) RUN	Acceleration time 4	V/F SVC FVC PMVF PMSVC PMFVC Set the value of acceleration time 4.	Depending on power level (Changing with F01.21)
F01.29 (0x011D) RUN	Deceleration time 4	V/F SVC FVC PMVF PMSVC PMFVC Set the value of deceleration time 4.	Depending on power level (Changing with F01.21)

S-Curve Selection

The S-Curve characteristic function can be used to enable smooth start and stop of the unit and reduce the impact on the load.

Set the S-Curve characteristic time at the beginning and the end of acceleration/deceleration as necessary.

This function is enabled with F01.30 = 1 [S-Curve selection = Valid]. Where the system needs high flexibility, such as elevators and lifting applications, F01.30 = 2 [S-Curve selection = Flexible S-Curve].

The S-Curve characteristics during operation switching (forward/reverse rotation) are shown in the figure below.

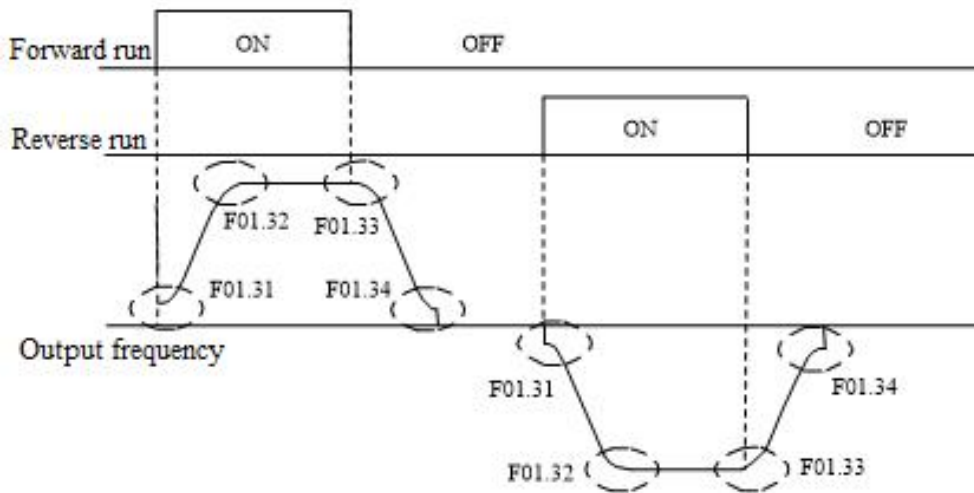

Diagram of S-Curve Characteristics

Note:

➤ After the S-Curve characteristic is set, the acceleration/deceleration time will be extended in the following way.

Acceleration time = Selected acceleration time + ([F01.31]+[F01.32])/2

Deceleration time = Selected deceleration time + ([F01.33]+[F01.34])/2

◇ F01.30: S-Curve Selection

Parameter Code (Address)	Name	Description	Default (Range)
F01.30 (0x011E) STOP	S-Curve Selection	V/F SVC FVC PMVF PMSVC PMFVC Selects whether the S-Curve function is enabled.	1 (0~2)

Note: The S-Curve for jogging is set with F07.33 [Jogging S-Curve selection].

0: Invalid

1: Valid

2: Flexible S-Curve

◇ **F01.31: S-curve Acceleration Start Time**

Parameter Code (Address)	Name	Description	Default (Range)
F01.31 (0x011F) STOP	S-curve acceleration start time	V/F SVC FVC PMVF PMSVC PMFVC Sets the S-curve acceleration start time.	0.20s (0.01s~10.00s)

◇ **F01.32: S-curve Acceleration End Time**

Parameter Code (Address)	Name	Description	Default (Range)
F01.32 (0x0120) STOP	S-curve acceleration end time	V/F SVC FVC PMVF PMSVC PMFVC Sets the S-curve acceleration end time.	0.20s (0.01s~10.00s)

◇ **F01.33: S-Curve Deceleration Start Time**

Parameter Code (Address)	Name	Description	Default (Range)
F01.33 (0x0121) STOP	S-curve deceleration start time	V/F SVC FVC PMVF PMSVC PMFVC Sets the S-curve deceleration start time.	0.20s (0.01s~10.00s)

◇ **F01.34: S-Curve Deceleration End Time**

Parameter Code (Address)	Name	Description	Default (Range)
F01.34 (0x0122) STOP	S-curve deceleration end time	V/F SVC FVC PMVF PMSVC PMFVC Sets the S-curve deceleration end time.	0.20s (0.01s~10.00s)

Switching Frequency of Acceleration/Deceleration Time

◇ **F01.35: Switching Frequency of Acceleration/Deceleration Time**

Parameter Code (Address)	Name	Description	Default (Range)
F01.35 (0x0123) RUN	Switching Frequency of Acceleration/Deceleration Time	V/F SVC FVC PMVF PMSVC PMFVC The frequency for switching of acceleration/deceleration time.	0.00Hz (0.00Hz~F01.10)

The acceleration/deceleration time of the drive will be automatically switched from acceleration/deceleration time 2 to acceleration/deceleration time 1 when the output frequency reaches the set point of F01.35 [Frequency for Switching of Acceleration/Deceleration Time].

Note:

➤ The function for switching acceleration/deceleration time is disabled when F01.35 = 0.00 Hz.

Group F01.4x: PWM Control

✧ F01.40: Carrier Frequency

Parameter Code (Address)	Name	Description	Default (Range)
F01.40 (0x0128) RUN	Carrier frequency	V/F SVC FVC PMVF PMSVC PMFVC Set the switching frequency (carrier frequency) of the power transistor in the drive.	Depending on power level (1.0 kHz - 16.0 kHz)

Change the setting when adjusting the electromagnetic noise or reducing noise and leakage current.

The relationship between carrier Defaults and drive power levels is shown in the table below.

Drive Power	Default of Carrier Frequency
<=11kW	4.0kHz
<=45kW	3.0kHz
Others	2.0kHz

Note:

- The carrier is defaulted to 2.0 kHz during DC braking.
- The carrier is defaulted to 2.0 kHz during Auto-tuning.

✧ F01.41: PWM Control Mode

Parameter Code (Address)	Name	Description	Default (Range)
F01.41 (0x0129) RUN	PWM control mode	V/F SVC FVC PMVF PMSVC PMFVC PWM control is optimized with this parameter setting.	1111 (0000~1211)

LED"0": Carrier dependency on temperature

- 0: Independent of temperature
- 1: Dependent on temperature

When the temperature of the drive is too high, the drive will automatically reduce the carrier frequency. This function can reduce the switching loss of power devices and prevent the drive from skipping overheat fault.

LED"00": Carrier dependency on output frequency

- 0: Independent of output frequency
- 1: Dependent on output Frequency

When the correlation between the carrier and output frequency is effective, the drive can automatically adjust the carrier frequency according to the output frequency. This function can improve the low frequency performance and the quietness at high frequency of the drive.

LED"000": Random PWM Enabling

- 0: Disabled
- 1: Valid under V/F mode
- 2: Valid under vector mode

LED"0000": PWM Modulation Mode

Selects the PWM mode of the drive

- 0: Three-phase modulation only

1: Automatic switching between two-phase and three-phase modulation

◇ **F01.43: Random Carrier Depth**

Parameter Code (Address)	Name	Description	Default (Range)
F01.43 (0x012B) RUN	Dead-Time Compensation Gain	V/F SVC FVC PMVF PMSVC PMFVC The gain for dead time compensation.	306 (0~512)

Note:

- When set to 0, dead time compensation is Invalid. Increasing this value will increase the dead-time compensation voltage.
- This value is automatically updated upon completion of Auto-tuning.

◇ **F01.46: Random Carrier Depth**

Parameter Code (Address)	Name	Description	Default (Range)
F01.46 (0x012E) RUN	PWM Random Depth	V/F SVC FVC PMVF PMSVC PMFVC The higher the set point, the greater the carrier fluctuation when random PWM is enabled.	0 (0~20)

11.4 Group F02: Motor 1 Parameters

Group F02 parameters are used to set motor 1 parameters, encoder and motor application parameters.

Group F02.0x: Basic Motor Parameters and Auto-tuning Selection

◇ **F02.00: Motor Type**

Parameter Code (Address)	Name	Description	Default (Range)
F02.00 (0x0200) READ	Motor type	V/F SVC FVC PMVF PMSVC PMFVC Set the type of motor. This parameter is read only.	0 (0~1)

0: Asynchronous motor (AM)

1: Permanent magnet synchronous motor (PM)

Note:

➤ This parameter is read only. F02.00 will be automatically updated when F01.00 [Control mode] is set.

◇ **F02.01: Number of Poles of Motor**

Parameter Code (Address)	Name	Description	Default (Range)
F02.01 (0x0201) STOP	Number of motor poles	V/F SVC FVC PMVF PMSVC PMFVC Set the number of poles of the motor.	4 (2~98)

◇ **F02.02: Rated Power of Motor**

Parameter Code (Address)	Name	Description	Default (Range)
F02.02 (0x0202) STOP	Rated motor power	V/F SVC FVC PMVF PMSVC PMFVC Sets the rated power of motor.	Model setting (0.1 kW~1,000.0 kW)

Note: The Default is the power of the drive for a G-model unit.

◇ **F02.03: Rated Frequency of Motor**

Parameter Code (Address)	Name	Description	Default (Range)
F02.03 (0x0203) STOP	Rated motor frequency	V/F SVC FVC PMVF PMSVC PMFVC Sets the rated frequency of motor.	50.00Hz (0.01Hz~F01.10)

◇ **F02.04: Rated Speed of Motor**

Parameter Code (Address)	Name	Description	Default (Range)
F02.04 (0x0204) STOP	Rated motor RPM	V/F SVC FVC PMVF PMSVC PMFVC Set the rated speed of motor.	Model setting (0 rpm~ 65,000 rpm)

Note:

When F02.00 [Motor type] is set to synchronous motor, F2.04 [Rated motor speed] is calculated with F2.01 [Motor poles] and F2.03 [Rated motor frequency]. Please set the parameters correctly. Formula: F2.04 [Rated motor speed] = $60 * F2.03$ [Rated motor frequency]/(F2.01 [Motor poles]/2).

◇ **F02.05: Rated Voltage of Motor**

Parameter Code (Address)	Name	Description	Default (Range)
F02.05 (0x0205) STOP	Rated motor voltage	V/F SVC FVC PMVF PMSVC PMFVC Set the rated voltage of motor.	Model setting (0 V~1,500 V)

◇ **F02.06: Rated Current of Motor**

Parameter Code (Address)	Name	Description	Default (Range)
F02.06 (0x0206) STOP	Rated motor current	V/F SVC FVC PMVF PMSVC PMFVC Set the rated current of motor.	Model setting (0.1 A ~3,000.0 A)

◇ **F02.07: Motor Parameter Auto-tuning Selection**

Parameter Code (Address)	Name	Description	Default (Range)
F02.07 (0x0207) STOP	Selection of motor parameter Auto-tuning	V/F SVC FVC PMVF PMSVC PMFVC Selection of motor parameter Auto-tuning.	0 (0~20)

Note: The set point of [F02.07] will be automatically set to "0" upon completion of parameter Auto-tuning.

0: No action

1: Rotary Auto-tuning

2: Static Auto-tuning

3: Stator Resistance Auto-tuning

4-20: Reserved

Group F02.1x: Advanced Parameters of Asynchronous Motor

◇ F02.10: no-load Current of Asynchronous Motor

Parameter Code (Address)	Name	Description	Default (Range)
F02.10 (0x020A) STOP	No-load current of asynchronous motor	V/F SVC FVC PMVF PMSVC PMFVC Set the no-load current of asynchronous motor.	Model setting (0.1 A~3,000.0 A)

◇ F02.11: Stator Resistance of Asynchronous Motor

Parameter Code (Address)	Name	Description	Default (Range)
F02.11 (0x020B) STOP	Stator resistance of asynchronous motor	V/F SVC FVC PMVF PMSVC PMFVC Sets the stator resistance of asynchronous motor.	Model setting (0.01 mΩ~60,000 mΩ)

Note: The number of decimal digits is set with the LED"0" of F02.19.

◇ F02.12: Rotor Resistance of Asynchronous Motor

Parameter Code (Address)	Name	Description	Default (Range)
F02.12 (0x020C) STOP	Rotor Resistance of Asynchronous Motor	V/F SVC FVC PMVF PMSVC PMFVC Sets the rotor resistance of asynchronous motor.	Model setting (0.01 mΩ~60,000 mΩ)

Note: The number of decimal digits is set with the LED"00" of F02.19.

◇ F02.13: Stator Leakage Inductance of Asynchronous Motor

Parameter Code (Address)	Name	Description	Default (Range)
F02.13 (0x020D) STOP	Stator leakage inductance of asynchronous motor	V/F SVC FVC PMVF PMSVC PMFVC Sets the stator leakage inductance of asynchronous motor.	Model setting (0.001 mH~6,553.5 mH)

Note: The number of decimal digits is set with the LED"000" of F02.19.

◇ F02.14: Stator Inductance of Asynchronous Motor

Parameter Code (Address)	Name	Description	Default (Range)
F02.14 (0x020E) STOP	Stator Inductance of Asynchronous Motor	V/F SVC FVC PMVF PMSVC PMFVC Sets the stator inductance of asynchronous motor.	Model setting (0.01 mH~65,535 mH)

Note: The number of decimal digits is set with the LED"0000" of F02.19.

◇ F02.15: Stator Resistance Per-Unit Value

Parameter Code	Name	Description	Default (Range)

(Address)	Name	Description	Default (Range)
F02.15 (0x020F) READ	Stator Resistance Per-Unit Value	V/F SVC FVC PMVF PMSVC PMFVC Sets the resistance per-unit value of stator. This parameter is read only.	Actual value conversion (0.01%~50.00%)

◇ **F02.16: Rotor Resistance Per-Unit Value**

Parameter Code (Address)	Name	Description	Default (Range)
F02.16 (0x0210) READ	Rotor Resistance Per-Unit Value	V/F SVC FVC PMVF PMSVC PMFVC Sets the resistance per-unit value of rotor. This parameter is read only.	Actual value conversion (0.01%~50.00%)

◇ **F02.17: Stator Leakage Inductance Per-Unit Value**

Parameter Code (Address)	Name	Description	Default (Range)
F02.17 (0x0211) READ	Stator leakage inductance per-unit value	V/F SVC FVC PMVF PMSVC PMFVC Sets the leakage inductance per-unit value of stator. This parameter is read only.	Actual value conversion (0.01%~50.00%)

◇ **F02.18: Stator Inductance Per-Unit Value**

Parameter Code (Address)	Name	Description	Default (Range)
F02.18 (0x0212) READ	Stator inductance per-unit value	V/F SVC FVC PMVF PMSVC PMFVC Sets the inductance per-unit value of stator. This parameter is read only.	Actual value conversion (0.1%~999.0%)

◇ **F02.19: F02.11 - F02.14 Decimal Point Selection**

Parameter Code (Address)	Name	Description	Default (Range)
F02.19 (0x0213) READ	F02.11 - F02.14 Decimal Point Selection	V/F SVC FVC PMVF PMSVC PMFVC Sets the decimal point of parameters F02.11 - F02.14. This parameter is read only.	0000 (0000~2222)

Note: The Default changes with the power level of the motor and does not change even if Defaults are restored.

0: No decimal point

1: 1 decimal digit

2: 2 decimal digits

3: 3 decimal digits

LED"0": Sets the number of decimal digits of parameter F02.11

LED"00": F02.12 parameter decimal point setting

LED"000": Sets the number of decimal digits of parameter F02.13

LED"0000": Sets the number of decimal digits of parameter F02.14

Group F02.2x: Advanced Parameters of Synchronous Motor

◇ **F02.20: Stator Resistance of Synchronous Motor**

Parameter Code (Address)	Name	Description	Default (Range)
F02.20 (0x0214) STOP	Stator Resistance of Synchronous Motor	V/F SVC FVC PMVF PMSVC PMFVC Set the stator resistance of synchronous motor.	Model setting (0.01 mΩ~ 60,000 mΩ)

Note: The number of decimal digits is set with the ones of F02.29.

◇ **F02.21: D-Axis Inductance of Synchronous Motor**

Parameter Code (Address)	Name	Description	Default (Range)
F02.21 (0x0215) STOP	D-Axis Inductance of Synchronous Motor	V/F SVC FVC PMVF PMSVC PMFVC Set the d-axis inductance of synchronous motor.	Model setting (0.001 mH~ 6,553.5 mH)

Note: The number of decimal digits is set with the LED"00" of F02.29.

◇ **F02.22: Q-Axis Inductance of Synchronous Motor**

Parameter Code (Address)	Name	Description	Default (Range)
F02.22 (0x0216) STOP	Q-Axis Inductance of Synchronous Motor	V/F SVC FVC PMVF PMSVC PMFVC Set the q-axis inductance of synchronous motor.	Model setting (0.001 mH~ 6,553.5 mH)

Note: The number of decimal digits is set with the LED"000" of F02.29.

◇ **F02.23: Back-EMF of Synchronous Motor**

Parameter Code (Address)	Name	Description	Default (Range)
F02.23 (0x0217) STOP	Back-EMF of synchronous motor	V/F SVC FVC PMVF PMSVC PMFVC Set the back-EMF of synchronous motor.	Model setting (0 V~1,500 V)

◇ **F02.24: Mounting Angle of Synchronous Motor Encoder**

Parameter Code (Address)	Name	Description	Default (Range)
F02.24 (0x0218) RUN	Mounting angle of synchronous motor encoder	V/F SVC FVC PMVF PMSVC PMFVC Set the mounting angle of synchronous motor encoder.	Model setting (0.0°~360.0°)

◇ **F02.25: Stator Resistance Per-Unit Value of Synchronous Motor**

Parameter Code (Address)	Name	Description	Default (Range)
F02.25 (0x0219) READ	Stator Resistance Per-Unit Value of Synchronous Motor	V/F SVC FVC PMVF PMSVC PMFVC Set the stator resistance per-unit value of synchronous motor. This parameter is read only.	Actual value conversion (monitor value)

◇ **F02.26: D-Axis Inductance Per-Unit Value of Synchronous Motor**

Parameter Code (Address)	Name	Description	Default (Range)
F02.26 (0x021A) READ	D-Axis Inductance Per-Unit Value of Synchronous Motor	V/F SVC FVC PMVF PMSVC PMFVC Set the d-axis inductance per-unit value of synchronous motor. This parameter is read only.	Actual value conversion (monitor value)

◇ **F02.27: Q-Axis Inductance Per-Unit Value of Synchronous**

Parameter Code (Address)	Name	Description	Default (Range)
F02.27 (0x021B) READ	Q-Axis Inductance Per-Unit Value of Synchronous Motor	V/F SVC FVC PMVF PMSVC PMFVC Set the q-axis inductance per-unit value of synchronous motor. This parameter is read only.	Actual value conversion (monitor value)

Note: The set point of [F02.07] will be automatically set to "0" upon completion of parameter Auto-tuning.

◇ **F02.28: Pulse Width Coefficient of Synchronous Motor**

Parameter Code (Address)	Name	Description	Default (Range)
F02.28 (0x021C) STOP	Pulse width coefficient of synchronous motor	V/F SVC FVC PMVF PMSVC PMFVC Pulse width coefficient of synchronous motor.	Model setting (0.00-99.99)

◇ **F02.29: F02.20 - F02.23 Decimal Point Selection**

Parameter Code (Address)	Name	Description	Default (Range)
F02.29 (0x021D) READ	Decimal place selection for F02.20 - F02.22	V/F SVC FVC PMVF PMSVC PMFVC Set the decimal places of three parameters F02.20 - F02.22. This parameter is read only.	0000 (0000~2222)

Note: The Default changes with the power level of the motor and does not change even if Defaults are restored.

0: No decimal point

1: 1 decimal digit

2: 2 decimal digits

3: 3 decimal digits

LED"0": F02.20 parameter decimal point setting

LED"00": F02.21 parameter decimal point setting

LED"000": F02.22 parameter decimal point setting

LED"0000": Reserved

Group F02.3x - F02.4x: Encoder Parameters

◇ F02.30: Speed Feedback Encoder Type

Parameter Code (Address)	Name	Description	Default (Range)
F02.30 (0x021E) STOP	Types of speed feedback encoder	V/F SVC FVC PMVF PMSVC PMFVC Set the speed feedback encoder type.	0 (0~1)

0: Ordinary ABZ encoder For use together with an optional PG card purchased from us.

1: Resolver For use together with an optional resolver card purchased from us.

◇ F02.31: Encoder Direction

Parameter Code (Address)	Name	Description	Default (Range)
F02.31 (0x021F) STOP	Encoder direction	V/F SVC FVC PMVF PMSVC PMFVC Set the encoder direction.	0 (0~1)

0: In the same direction

1: In the opposite direction

◇ F02.32: ABZ Encoder Z Pulse Detection Selection

Parameter Code (Address)	Name	Description	Default (Range)
F02.32 (0x0220) STOP	ABZ Encoder Z Pulse Detection Selection	V/F SVC FVC PMVF PMSVC PMFVC Sets the ABZ encoder Z pulse detection selection.	1 (0~2)

0: OFF

1: ON (positive pulse)

2: ON (negative pulse)

◇ F02.33: Number of ABZ Encoder Pulse

Parameter Code (Address)	Name	Description	Default (Range)
F02.33 (0x0221) STOP	Number of ABZ encoder pulse	V/F SVC FVC PMVF PMSVC PMFVC Sets the number of ABZ encoder pulse.	1024 (1~10000)

◇ F02.34: Number of Resolver Poles

Parameter Code (Address)	Name	Description	Default (Range)
F02.34 (0x0222) STOP	Number of rotary transformer poles	V/F SVC FVC PMVF PMSVC PMFVC Set the number of resolver poles.	2 (2~128)

◇ F02.35: Encoder Transmission Ratio Numerator

Parameter Code (Address)	Name	Description	Default (Range)
F02.35 (0x0223) RUN	Encoder transmission ratio numerator	V/F SVC FVC PMVF PMSVC PMFVC Set the numerator of encoder transmission ratio.	1 (1~32767)

◇ F02.36: Encoder Transmission Ratio Denominator

Parameter Code (Address)	Name	Description	Default (Range)
F02.36 (0x0224) RUN	Encoder Transmission Ratio Denominator	V/F SVC FVC PMVF PMSVC PMFVC Set the denominator of encoder transmission ratio.	1 (1~32767)

Note: If the encoder is mounted on the non-motor side, the transmission ratio correctly, or closed-loop vector control is impossible.

◇ F02.37: Encoder Speed Measurement Filter Time

Parameter Code (Address)	Name	Description	Default (Range)
F02.37 (0x0225) RUN	Encoder speed measurement filter time	V/F SVC FVC PMVF PMSVC PMFVC Set the filter time for encoder speed measurement.	1.0ms (0.0ms~100.0ms)

Note: The speed measurement filter time may be increased appropriately in places with heavy feedback interference with motor encoder. Increase the time with an increment of 1.0 ms to ensure stable operation of the system.

◇ F02.38: Encoder disconnection Detection Time

Parameter Code (Address)	Name	Description	Default (Range)
F02.38 (0x0226) RUN	Encoder disconnection detection time	V/F SVC FVC PMVF PMSVC PMFVC Set the time required for encoder disconnection detection.	0.500s (0.100s~60.000s)

Note: disconnection detection is not conducted when [F02.38] encoder disconnection detection time is set to "0".

✧ **F02.47: Allowable Deviation of Z Pulse**

Parameter Code (Address)	Name	Description	Default (Range)
F02.47 (0x022F) RUN	Allowable Deviation of Z Pulse	V/F SVC FVC PMVF PMSVC PMFVC Set the allowable deviation of Z pulse.	0 (0~65535)

✧ **F02.48: Learning Current Value of Z Pulse**

Parameter Code (Address)	Name	Description	Default (Range)
F02.48 (0x0230) RUN	Learning Current Value of Z Pulse	V/F SVC FVC PMVF PMSVC PMFVC Set the learning current value of Z pulse.	0 (0~65535)

✧ **F02.49: Encoder Debug Register**

Parameter Code (Address)	Name	Description	Default (Range)
F02.49 (0x0231) RUN	Encoder Debug Register	V/F SVC FVC PMVF PMSVC PMFVC LED"0": Monitor PG feedback under SVC mode 0: Invalid 1: Valid	0000 (0000~FFFF)

Group F02.5x: Motor Application Parameters**Stator Resistance Online Auto-tuning**✧ **F02.50: Stator Resistance Online Auto-tuning Mode**

Parameter Code (Address)	Name	Description	Default (Range)
F02.50 (0x0232) STOP	Stator resistance Start learning function selection	V/F SVC FVC PMVF PMSVC PMFVC Set the mode of stator resistance online learning.	0 (0~3)

0: Invalid.**1: Learning without updating.****Greater than 1: Learning and updating. Moreover, this value limits the stator resistance increase as learned during each Start learning.****Note:** The stator resistance Auto-tuning function is effective only after the motor self-setting is completed once.

◇ F02.51: Stator Resistance Online Auto-tuning Coefficient 1

Parameter Code (Address)	Name	Description	Default (Range)
F02.51 (0x0233) RUN	Stator resistance Start learning coefficient 1	V/F SVC FVC PMVF PMSVC PMFVC Stator resistance Start learning coefficient 1.	0 (0~1000)

Note: This value records the stator resistance increment as updated actually.

◇ F02.52: Stator Resistance Online Auto-tuning Coefficient 2

Parameter Code (Address)	Name	Description	Default (Range)
F02.52 (0x0234) RUN	Stator resistance Start learning coefficient 2	V/F SVC FVC PMVF PMSVC PMFVC Stator resistance Start learning coefficient 2.	0 (-20.00%~20.00%)

Note: This value records the voltage increment reference used in stator resistance Start learning. (for debugging and monitoring)

◇ F02.53: Stator Resistance Online Auto-tuning Coefficient 3

Parameter Code (Address)	Name	Description	Default (Range)
F02.53 (0x0235) RUN	Stator resistance Start learning coefficient 3	V/F SVC FVC PMVF PMSVC PMFVC Stator resistance Start learning coefficient 3.	0 (0~65535)

Note: This value records the time required for current stabilization in stator resistance Start learning.

Magnetic Pole Search of Synchronous Motor

In the synchronous motor control mode, the initial position of the motor rotor can be obtained upon starting with the magnetic pole search function.

In the closed-loop vector control mode, this function should be used to obtain the initial starting position of the motor when the motor encoder has not learned initial position.

In the open-loop vector control mode, obtaining the initial position of the motor ensures that the output is high and the motor does not reverse upon starting.

for synchronous closed-loop applications using ABZ encoders, the magnetic pole position of the motor is unknown before Z pulse is detected. In this case, it is recommended to enable the magnetic pole search function to ensure a smooth starting process without reserving.

✧ **F02.60: Magnetic Pole Search of Synchronous Motor**

Parameter Code (Address)	Name	Description	Default (Range)
F02.60 (0x023C) STOP	Magnetic pole search of synchronous motor	V/F SVC FVC PMVF PMSVC PMFVC Set the magnetic pole search function of synchronous motor.	0010 (0000~3223)

LED"0": Closed-loop vector

- 0: OFF
- 1: ON
- 2: ON, started only for the first time on power-on

LED"00": Open-loop vector

- 0: OFF
- 1: ON
- 2: ON, started only for the first time on power-on

LED"000": VF

- 0: OFF
- 1: ON
- 2: ON, started only for the first time on power-on

✧ **F02.61: Magnetic Pole Search Current Set Point**

Parameter Code (Address)	Name	Description	Default (Range)
F02.61 (0x023D) STOP	Pole search current set point	V/F SVC FVC PMVF PMSVC PMFVC Set the pole search current set point.	0.0% (0.0%~6553.5%)

11.5 Group F03: Vector Control

Group F03.0x: Speed Loop (ASR)

ASR is a function for adjusting torque commands by making the motor speed and the speed command tend to be consistent.

- Before adjustment of ASR parameters
 - Before adjusting ASR parameters, be sure to conduct Auto-tuning and set all motor parameters properly.
 - Adjust the ASR parameters only with the motor connected to the load.
 - When adjusting ASR, it is possible to monitor C00.01 (the LED"0" of F11.20 is set to 1 to select the actual output frequency) and C00.05 [Mechanical Speed] and use analog output signals.

■ Adjustment steps in SVC, FVC, PMSVC, PMFVC Control Modes

Perform the following steps for adjustment of ASR parameters.

1. Run the motor at zero speed or a low speed, and increase F03.06 [Speed Loop Proportional Gain 2] to the extent that does not cause vibration.
2. Run the motor at zero speed or a low speed, and decrease F03.07 [Speed Loop Integral Time 2] to the extent that does not

cause vibration.

3. Run the motor at the set maximum speed to check if vibration occurs.
4. If vibration occurs, increase the set point of F03.07 and decrease the set point of F03.06 until no more vibration occurs.
5. Set the gain in the low speed domain. Run the motor at zero speed or a low speed, and increase F03.02 [Speed Loop Proportional Gain 1] to the extent that does not cause vibration.
6. The ASR proportional gain and integral time can be switched based on the output frequency. If the speed is instable on the low speed side, roughly set about 80% of the frequency at which the actual vibration occurs. If the speed is instable on the high speed side, roughly set about 120% of the frequency at which the actual vibration occurs.

Switching Frequency 1 > Switching Frequency 2

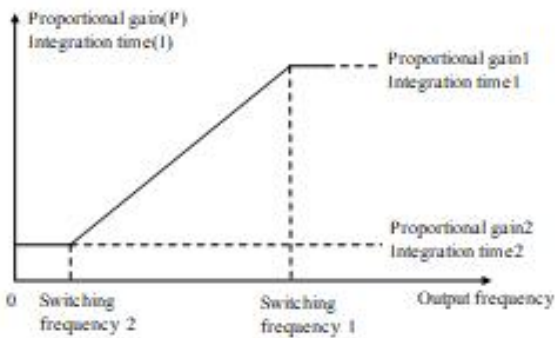

Switching Frequency 1 < Switching Frequency 2

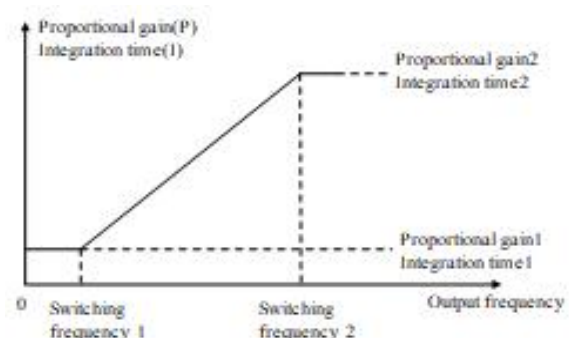

Diagram of Setting of Speed Loop Proportional Gain and Integral Time

◇ F03.00: ASR Speed Rigidity Class

Parameter Code (Address)	Name	Description	Default (Range)
F03.00 (0x0300) RUN	ASR speed rigidity class	V/F SVC FVC PMVF PMSVC PMFVC Set the rigidity class of ASR speed.	32 (1~128)

Note:

- Sets the rigidity class. The higher the class, the better the speed rigidity.

◇ F03.01: ASR Speed Rigidity Mode

Parameter Code (Address)	Name	Description	Default (Range)
F03.01 (0x0301) RUN	ASR speed rigidity mode	V/F SVC FVC PMVF PMSVC PMFVC Set the rigidity mode of ASR speed.	0000 (0000~FFFF)

◇ F03.02: ASR (Speed Loop) Proportional Gain 1

Parameter Code (Address)	Name	Description	Default (Range)
F03.02 (0x0302) RUN	ASR (Speed Loop) Proportional Gain 1	V/F SVC FVC PMVF PMSVC PMFVC Set the ASR (speed loop) proportional gain 1.	10.00 (0.01~100.00)

Increasing the gain improves responsiveness. Usually, the gain should be increased accordingly for larger loads. However, the motor will vibrate if the gain is too high.

◇ F03.03: ASR (Speed Loop) Integral Time 1

Parameter Code (Address)	Name	Description	Default (Range)
F03.03 (0x0303) RUN	ASR (Speed Loop) Integral Time 1	V/F SVC FVC PMVF PMSVC PMFVC Set the ASR (speed loop) integral time 1.	0.100s (0.000s~6.000s)

The responsiveness will decrease and the ability to resist external forces will also be impaired if the integral time is too long. Vibration will occur if the integral time is too short.

◇ **F03.04: ASR Filter Time 1**

Parameter Code (Address)	Name	Description	Default (Range)
F03.04 (0x0304) RUN	ASR Filter Time 1	V/F SVC FVC PMVF PMSVC PMFVC Set ASR filter time 1.	0.0ms (0.0ms~100.0ms)

Increase the set point by 0.1 gradually if the unit has low rigidity and is likely to vibrate.

◇ **F03.05: ASR Switching Frequency 1**

Parameter Code (Address)	Name	Description	Default (Range)
F03.05 (0x0305) RUN	ASR switching frequency 1	V/F SVC FVC PMVF PMSVC PMFVC Set ASR switching frequency 1.	0.00Hz (0.00Hz~F01.10)

Note: This parameter determines ASR control parameter selection together with F03.09.

◇ **F03.06: ASR (Speed Loop) Proportional Gain 2**

Parameter Code (Address)	Name	Description	Default (Range)
F03.06 (0x0306) RUN	ASR (Speed Loop) Proportional Gain 2	V/F SVC FVC PMVF PMSVC PMFVC Set the ASR (speed loop) proportional gain 1.	10.00 (0.01~100.00)

Increasing the gain improves responsiveness. Usually, the gain should be increased accordingly for larger loads. However, the motor will vibrate if the gain is too high.

◇ **F03.07: ASR (Speed Loop) Integral Time 2**

Parameter Code (Address)	Name	Description	Default (Range)
F03.07 (0x0307) RUN	ASR (Speed Loop) Integral Time 2	V/F SVC FVC PMVF PMSVC PMFVC Set the ASR (speed loop) integral time 1.	0.100s (0.001s~6.000s)

The responsiveness will decrease and the ability to resist external forces will also be impaired if the integral time is too long. Vibration will occur if the integral time is too short.

◇ **F03.08: ASR Filter Time 2**

Parameter Code (Address)	Name	Description	Default (Range)
F03.08	ASR Filter Time 2	V/F SVC FVC PMVF PMSVC PMFVC	0.0ms

(0x0308) RUN		Set ASR filter time 2.	(0.0ms~100.0ms)
-----------------	--	------------------------	-----------------

Increase the set point by 0.1 gradually if the unit has low rigidity and is likely to vibrate.

◇ F03.09: ASR Switching Frequency 2

Parameter Code (Address)	Name	Description	Default (Range)
F03.09 (0x0309) RUN	ASR Switching Frequency 2	V/F SVC FVC PMVF PMSVC PMFVC Set ASR switching frequency 2.	0.00Hz (0.00Hz~F01.10)

It is possible to switch the ASR proportional gain and integral time based on the output frequency if the speed is instable on the low speed side or the high speed side.

Description of the speed loop parameter switching with the output frequency when the set point of F03.05 is greater than that of F03.09.

Output Frequency	Velocity Loop Parameter		
	Proportional Gain	Integral Time	Filter Time
Output Frequency >= F03.05	F03.02	F03.03	F03.04
F03.09 < Output Frequency < F03.05	Linear variation	Linear variation	Linear variation
Output Frequency <= F03.09	F03.06	F03.07	F03.08

Description of the speed loop parameter switching with the output frequency when the set point of F03.09 is greater than that of F03.05.

Output Frequency	Velocity Loop Parameter		
	Proportional Gain	Integral Time	Filter Time
Output Frequency <= F03.05	F03.02	F03.03	F03.04
F03.05 < Output Frequency < F03.09	Linear variation	Linear variation	Linear variation
Output Frequency >= F03.09	F03.06	F03.07	F03.08
F03.09=F03.05	F03.02	F03.03	F03.04

Group F03.1x: Current Loop and Torque Limit

Sets the PI parameters of current loop in vector control of asynchronous motors and synchronous motors. In the case of vector control, if speed or current oscillation and instability occur, decrease the individual gain values appropriately to keep stability. Increasing individual gain values may improve the dynamic response of the motor.

◇ F03.10: Current Loop D-Axis Proportional Gain

Parameter Code (Address)	Name	Description	Default (Range)
F03.10 (0x030A) RUN	Current loop D-axis proportional gain	V/F SVC FVC PMVF PMSVC PMFVC Set the current loop D-axis proportional gain.	1.000 (0.001~4.000)

◇ F03.11: Current Loop D-Axis Integral Gain

Parameter Code	Name	Description	Default (Range)

(Address)			
F03.11 (0x030B) RUN	Current loop D-axis integral gain	V/F SVC FVC PMVF PMSVC PMFVC Set the current loop D-axis integral gain.	1.000 (0.001~4.000)

◇ F03.12: Current Loop Q-Axis Proportional Gain

Parameter Code (Address)	Name	Description	Default (Range)
F03.12 (0x030C) RUN	Current Loop Q-Axis Proportional Gain	V/F SVC FVC PMVF PMSVC PMFVC Set the current loop Q-axis proportional gain.	1.000 (0.001~4.000)

◇ F03.13: Current Loop Q-Axis Integral Gain

Parameter Code (Address)	Name	Description	Default (Range)
F03.13 (0x030D) RUN	Current Loop Q-Axis Integral Gain	V/F SVC FVC PMVF PMSVC PMFVC Set the current loop Q-axis integral gain.	1.000 (0.001~4.000)

◇ F03.14: Reserved

Parameter Code (Address)	Name	Description	Default (Range)
F03.14 (0x030E) RUN	Reserved	V/F SVC FVC PMVF PMSVC PMFVC Setting.	Depending on model (0-0)

◇ F03.15: Torque Limit in Drive State

Parameter Code (Address)	Name	Description	Default (Range)
F03.15 (0x030F) RUN	Torque Limit in Drive State	V/F SVC FVC PMVF PMSVC PMFVC Sets the torque limit in drive state.	250.0% (0.0%~400.0%)

Note: 100.0% corresponds to the rated torque of motor.

◇ **F03.16: Torque Limit in Power Generation State**

Parameter Code (Address)	Name	Description	Default (Range)
F03.16 (0x0310) RUN	Torque Limit in Power Generation State	V/F SVC FVC PMVF PMSVC PMFVC Set the torque limit in power generation state.	250.0% (0.0%~400.0%)

Note: 100.0% corresponds to the rated torque of motor.

The motor torque output is also limited by the torque converted by F10.01 [Overcurrent suppression point] and F03.34 [Output power limit].

◇ **F03.17: Regenerative Torque Limit at Low Speed**

Parameter Code (Address)	Name	Description	Default (Range)
F03.17 (0x0311) RUN	Regenerative Torque Limit at Low Speed	V/F SVC FVC PMVF PMSVC PMFVC Set the regenerative torque limit at low speed. 100.0% corresponds to the rated torque of motor.	0.0% (0.0%~400.0%)

◇ **F03.18: Frequency and Amplitude for Torque Limit Action at Low Speed**

Parameter Code (Address)	Name	Description	Default (Range)
F03.18 (0x0312) RUN	Frequency and amplitude for torque limit action at low speed	V/F SVC FVC PMVF PMSVC PMFVC Set the frequency and amplitude for torque limit action at low speed.	6.00Hz (0.00Hz~30.00Hz)

◇ **F03.19: Torque Limit Selection**

Parameter Code (Address)	Name	Description	Default (Range)
F03.19 (0x0313) RUN	Torque Limit Selection	V/F SVC FVC PMVF PMSVC PMFVC Set the power generation torque limit and drive torque limit respectively, and the torque monitoring display.	0000 (0000~0177)

LED"0": Select torque limit channel in drive state.

0: Keypad digital

1: Keypad potentiometer (optional outer single-line keypad)

2: AI1

3: AI2

4: Reserved

5: PUL

6: Set via RS485 communication (0x3014)

7: Option card

LED"00": Selects torque limit channel in power generation state.

0: Keypad digital

1: Keypad potentiometer (optional outer single-line keypad)

2: AI1

3: AI2

4: Reserved

5: PUL

6: Set via RS485 communication (0x3015)

7: Option card

LED"000":

0: C00.06 Display the torque limit value in drive state

1: C00.06 Display the torque limit value in the power generation state

LED"0000": Reserved

Group F03.2x: Torque Optimization Control

Pull-in Current of Synchronous Motor

The pull-in current is mainly used to improve the load capacity of the motor at low frequencies. F03.22 [Pull-in current frequency] is taken as the divide between high and low frequencies. When the low frequency load is large, the pull-in current at low frequencies can be appropriately increased. As excessive pull-in current will affect the operation efficiency of the motor, the pull-in current should be set depending on load conditions in actual use.

◇ **F03.20: Low Frequency Pull-in Current of Synchronous Motor**

Parameter Code (Address)	Name	Description	Default (Range)
F03.20 (0x0314) RUN	Low frequency pull-in current of synchronous motor	V/F SVC FVC PMVF PMSVC PMFVC Set the low frequency pull-in current of synchronous motor.	20.0% (0.0%~50.0%)

Note: The set point of 100.0% corresponds to the rated current of motor.

◇ **F03.21: High Frequency Pull-in Current of Synchronous Motor**

Parameter Code (Address)	Name	Description	Default (Range)
F03.21 (0x0315) RUN	High frequency pull-in current of synchronous motor	V/F SVC FVC PMVF PMSVC PMFVC Set the high frequency pull-in current of synchronous motor.	10.0% (0.0%~50.0%)

Note: The set point of 100.0% corresponds to the rated current of motor.

◇ **F03.22: Pull-In Current Frequency of Synchronous Motor**

Parameter Code (Address)	Name	Description	Default (Range)
F03.22 (0x0316) RUN	Pull-in current frequency of synchronous motor	V/F SVC FVC PMVF PMSVC PMFVC Set the pull-in current frequency of synchronous motor.	10.0% (0.0%~100.0%)

Note: The set point of 100.0% corresponds to F01.10 [Maximum frequency].

Slip Compensation

In the vector control mode of asynchronous motors, the slip compensation coefficient is used to adjust the speed stabilization accuracy of the motor in the case of open-loop vector control. Increase the value when the speed of the motor is lower than the

set point after loading, and vice versa. The recommended value range is between 60% and 160%.

In the case of closed-loop vector control, this value is used to adjust the linearity of the output torque and output current of the motor. Decrease the value when the motor works with a rated load and the motor current deviates notably from the rated value on the nameplate, or decrease the value if the deviation is small. The recommended value range is between 80% and 120%.

✧ F03.23: Slip Compensation

Parameter Code (Address)	Name	Description	Default (Range)
F03.23 (0x0317) RUN	Slip compensation	V/F SVC FVC PMVF PMSVC PMFVC Sets the slip compensation of motor.	100.0% (0.0%~250.0%)

✧ F03.24: Initial Value of Starting Torque

Parameter Code (Address)	Name	Description	Default (Range)
F03.24 (0x0318) RUN	Initial value of starting torque	V/F SVC FVC PMVF PMSVC PMFVC Sets the initial value of starting torque.	0.0% (0.0%~250.0%)

Group F03.3x: Flux Optimization

Field Weakening

In the case of vector control of asynchronous and synchronous motors, the drive needs to conduct field weakening control of the motor to ensure that the motor speed follows the set speed if the motor working above the rated speed, or when the bus voltage is low and the motor's running speed is near the rated speed.

F03.32 can be used to set the upper limit of field weakening current. Excessive field weakening current will cause irreversible demagnetization of the motor. In most cases, irreversible demagnetization of the motor will not happen if the field weakening current is within the rated current of the motor.

F03.30 - F03.31 set the adjustment parameters of field weakening control. Adjust these parameters when instability occurs in the case of field weakening.

✧ F03.30: Feed-forward Coefficient of Field Weakening

Parameter Code (Address)	Name	Description	Default (Range)
F03.30 (0x031E) RUN	Field weakening feed- forward coefficient	V/F SVC FVC PMVF PMSVC PMFVC Set the feed-forward coefficient of field weakening.	10.0% (0.0%~500.0%)

✧ **F03.31: Field Weakening Control Gain**

Parameter Code (Address)	Name	Description	Default (Range)
F03.31 (0x031F) RUN	Field weakening control gain	V/F SVC FVC PMVF PMSVC PMFVC Set the gain of field weakening control.	10.0% (0.0%~500.0%)

✧ **F03.32: Field Weakening Current Upper Limit**

Parameter Code (Address)	Name	Description	Default (Range)
F03.32 (0x0320) RUN	Field weakening current upper limit	V/F SVC FVC PMVF PMSVC PMFVC Set the upper limit of field weakening current.	60.0% (0.0%~250.0%)

Note: The set point of 100.0% corresponds to the rated current of motor.

✧ **F03.33: Field Weakening Voltage Coefficient**

Parameter Code (Address)	Name	Description	Default (Range)
F03.33 (0x0321) RUN	Field weakening voltage coefficient	V/F SVC FVC PMVF PMSVC PMFVC Set the field weakening voltage coefficient.	97.0% (0.0%~120.0%)

✧ **F03.34: Output Power Limit**

Parameter Code (Address)	Name	Description	Default (Range)
F03.34 (0x0322) RUN	Output power limit	V/F SVC FVC PMVF PMSVC PMFVC Set the output power limit of motor.	250.0% (0.0%~400.0%)

Note: The set point of 100.0% corresponds to the rated power of the motor.

Over-excitation Brake

This parameter is effective for vector control of asynchronous motors. Faster deceleration control can be realized without reporting overvoltage through over-excitation function. The greater the over-excitation gain, the faster the control response. The braking limit is relative to the rated excitation of the motor. The greater the braking limit, the better the braking effect. However, excessive limit will lead to temperature rise when the motor decelerates, and the value may be increased appropriately only when the motor has favorable conditions of heat dissipation.

✧ **F03.35: Over-excitation Brake Gain**

Parameter Code (Address)	Name	Description	Default (Range)
F03.35 (0x0323) RUN	Over-excitation brake gain	V/F SVC FVC PMVF PMSVC PMFVC Set the over-excitation brake gain.	100.0% (0.0%~250.0%)

◇ **F03.36: Over-excitation Brake Limit**

Parameter Code (Address)	Name	Description	Default (Range)
F03.36 (0x0324) RUN	Over-excitation brake limit	V/F SVC FVC PMVF PMSVC PMFVC Set the over-excitation brake limit.	100.0% (0.0%~250.0%)

Energy-saving operation

This parameter is effective for vector control of asynchronous motors. In the case of energy-saving operation, the output current is automatically reduced by analyzing the torque output to reduce the heating loss of the motor and achieve energy-saving.

◇ **F03.37: Energy-Saving running**

Parameter Code (Address)	Name	Description	Default (Range)
F03.37 (0x0325) RUN	Energy-saving running	V/F SVC FVC PMVF PMSVC PMFVC Set the energy-saving running function.	0 (0~1)

0: OFF

1: ON

◇ **F03.38: Lower Excitation Limit in Energy-Saving running**

Parameter Code (Address)	Name	Description	Default (Range)
F03.38 (0x0326) RUN	Lower excitation limit in energy-saving running	V/F SVC FVC PMVF PMSVC PMFVC Set the lower excitation limit in energy-saving running.	50.0% (0.0%~80.0%)

Note: The set point is 100.0% of the rated excitation of motor.

◇ **F03.39: Filter Coefficient in Energy-Saving running**

Parameter Code (Address)	Name	Description	Default (Range)
F03.39 (0x0327) RUN	Filter coefficient of energy-saving running	V/F SVC FVC PMVF PMSVC PMFVC Sets the filter coefficient of energy-saving running.	0.010s (0.000s~6.000s)

Group F03.4x~F03.5x: Torque Control

Torque command setting

◇ F03.40: Torque Control Selection

Parameter Code (Address)	Name	Description	Default (Range)
F03.40 (0x0328) RUN	Torque control selection	V/F SVC FVC PMVF PMSVC PMFVC Set the torque control selection.	0 (0~1)

0: Speed control selection

1: Torque control selection

Note:

- F5.0x = 60 [Multi-Function input terminal = Switch to torque control] with priority higher than F03.40 [Torque control selection].

◇ F03.41: Torque Command Setting

Parameter Code (Address)	Name	Description	Default (Range)
F03.41 (0x0329) RUN	Torque command setting	V/F SVC FVC PMVF PMSVC PMFVC Set how torque commands are set.	0000 (0000~0599)

LED"0": Torque Setting Channel A

- 0: Torque set with numbers Set with F03.42.
- 1: Set with Keypad potentiometer (optional outer single-line keypad)
- 2: AI1 input
- 3: AI2 input
- 4: Reserved
- 5: PUL input
- 6: Set via RS485 communication Communication address at 0x3005.
- 7: Option card Refer to the instructions of the option card for the communication address of the option card.
- 8: Reserved
- 9: Sets with tension calculation

LED"00": Torque Setting Channel B The same as the torque setting channel A

LED"000": Combination of Channels A and B

- 0: Torque setting channel A
- 1: Torque setting channel B
- 2: Sum of frequency setting channel A and frequency setting channel B
- 3: Difference between frequency setting channel A and frequency setting channel B (A - B)
- 4: Frequency setting channel A or frequency setting channel B, whichever the smaller
- 5: Frequency setting channel A or frequency setting channel B, whichever the larger

LED"0000": Reserved

◇ F03.42: Torque Given by Keypad Digital

Parameter Code (Address)	Name	Description	Default (Range)
F03.42 (0x032A) RUN	Torque given by digital	V/F SVC FVC PMVF PMSVC PMFVC Set the torque given.	0.0% (0.0%~100.0%)

Note:

➤ The set point of 100% corresponds to the rated torque of motor.

◇ F03.43: Torque Input Lower Limit

Parameter Code (Address)	Name	Description	Default (Range)
F03.43 (0x032B) RUN	Torque input lower limit	V/F SVC FVC PMVF PMSVC PMFVC Set the lower limit of torque input.	0.00% (0.00%~100.00%)

◇ F03.44: Corresponding Setting of Lower Torque Limit

Parameter Code (Address)	Name	Description	Default (Range)
F03.44 (0x032C) RUN	Corresponding setting of lower torque limit	V/F SVC FVC PMVF PMSVC PMFVC Set the corresponding setting of lower torque limit.	0.00% (-250.00%~300.00%)

Note: The set point of 100% corresponds to the rated torque of motor.

◇ F03.45: Torque Input Upper Limit

Parameter Code (Address)	Name	Description	Default (Range)
F03.45 (0x032D) RUN	Torque input upper limit	V/F SVC FVC PMVF PMSVC PMFVC Set the upper limit of torque input.	100.00% (0.00%~100.00%)

◇ F03.46: Corresponding Setting of Upper Torque Limit

Parameter Code (Address)	Name	Description	Default (Range)
F03.46 (0x032E) RUN	Upper torque limit setting	V/F SVC FVC PMVF PMSVC PMFVC Set the upper torque limit.	100.00% (-250.00%~300.00%)

Note: The set point of 100% corresponds to the rated torque of motor.

◇ F03.47: Torque Filter Time

Parameter Code (Address)	Name	Description	Default (Range)
F03.47 (0x032F) RUN	Torque filter time	V/F SVC FVC PMVF PMSVC PMFVC Set the torque filter time.	0.100s (0.000s~6.000s)

Filter the torque command signal to reduce the vibration caused by the signal, which will efficiently remove interference from the

signal and improve the response time to the command controller.

In case of vibration during torque control, please set a higher set point. However, delayed response may occur if the set point is too high.

//Not included in the instruction manual

◇ **F03.48: Speed Limit Selection**

Parameter Code (Address)	Name	Description	Default (Range)
F03.48 (0x0330) RUN	Speed limit selection	V/F SVC FVC PMVF PMSVC PMFVC Set the speed limit.	0 (0~1)

0: Frequency command

1: Speed limit number setting

◇ **F03.52: Torque Command Upper Limit**

Parameter Code (Address)	Name	Description	Default (Range)
F03.52 (0x0334) RUN	Torque command upper limit	V/F SVC FVC PMVF PMSVC PMFVC Set the torque command upper limit.	150.0% (0.0%~300.0%)

◇ **F03.53: Torque Command Lower Limit**

Parameter Code (Address)	Name	Description	Default (Range)
F03.53 (0x0335) RUN	Torque command lower limit	V/F SVC FVC PMVF PMSVC PMFVC Set the torque command lower limit.	0.0% (0.0%~300.0%)

Note: Set the upper and lower limits based on the absolute value of the linearly processed torque command value.

Speed Limit

◇ **F03.54: Torque Control Forward Speed Limit Selection**

Parameter Code (Address)	Name	Description	Default (Range)
F03.54 (0x0336) RUN	Selection of torque control forward speed limit	V/F SVC FVC PMVF PMSVC PMFVC Set the torque control forward speed limit.	0 (0~8)

0: The forward speed limit number is set through F03.56.

1: Set with Keypad potentiometer (optional outer single-line keypad)

2: AI1 input

3: AI2 input

4: Reserved

5: PUL input

6: RS485 communication The communication address is 0x3006.

7. Option card Refer to the instructions of the option card for the communication address of the option card.

8: Reserved

◇ **F03.55: Torque Control Reverse Speed Limit Selection**

Parameter Code (Address)	Name	Description	Default (Range)
F03.55 (0x0337) RUN	Selection of torque control reverse speed limit	V/F SVC FVC PMVF PMSVC PMFVC Set the torque control reverse speed limit.	0 (0~8)

0: The reverse speed limit number is set through F03.57.

1: Set with Keypad potentiometer (optional outer single-line keypad)

2: AI1 input

3: AI2 input

4: Reserved

5: PUL input

6: RS485 communication The communication address is 0x3007.

7: Option card Refer to the Instruction Manual of Option Card for its communication address.

8: Reserved

◇ **F03.56: Torque Control Forward Speed Limit Selection**

Parameter Code (Address)	Name	Description	Default (Range)
F03.56 (0x0338) RUN	Forward speed limit number/gain setting	V/F SVC FVC PMVF PMSVC PMFVC Set the forward speed limit number/gain.	100.0% (0.0%~100.0%)

Note:

➤ When setting the forward speed limit number, the set point of 100.0% corresponds to the maximum frequency.

◇ **F03.57: Torque Control Reverse Speed Limit Selection**

Parameter Code (Address)	Name	Description	Default (Range)
F03.57 (0x0339) RUN	Reverse speed limit number/gain setting	V/F SVC FVC PMVF PMSVC PMFVC Set the reverse speed limit number/gain.	100.0% (0.0%~100.0%)

Note:

➤ When setting the reverse speed limit number, the set point of 100.0% corresponds to the maximum frequency.

Torque Command Gain Changeover

When the output frequency is lower than F03.58, increase or decrease the set torque by setting F03.59.

◇ **F03.58: Switching Frequency of the Set Torque Gain**

Parameter Code (Address)	Name	Description	Default (Range)
F03.58 (0x033A) RUN	Torque gain switching frequency setting	V/F SVC FVC PMVF PMSVC PMFVC Set the torque gain switching frequency.	1.00Hz (0.00Hz~50.00Hz)

◇ **F03.59: Set Torque Gain**

Parameter Code (Address)	Name	Description	Default (Range)
F03.59 (0x033B) RUN	Torque gain setting	V/F SVC FVC PMVF PMSVC PMFVC Set the torque gain.	100.0% (0.0%~500.0%)

Group F03.6x: PM High-Frequency Injection

The high-frequency injection function is available at a low speed (10% of the motor rated frequency by default) to increase the torque output.

◇ **F03.60: High-Frequency Injection Mode**

Parameter Code (Address)	Name	Description	Default (Range)
F03.60 (0x033C) STOP	High-frequency injection mode	V/F SVC FVC PMVF PMSVC PMFVC Set the high-frequency injection mode.	Model Setting (0~5)

To activate the PM motor open-loop control: select 0 when using an SPM motor, while select 0-5 when using an IPM motor.

0: Disabled

1-5: Enabled. The greater the value, the higher the injection frequency.

Note: When the motor saliency ratio (the ratio of F02.22 to F02.21) is less than 1.5, the effect of high-frequency injection on the motor output torque will be reduced.

◇ **F03.61: High-Frequency Injection Voltage**

Parameter Code (Address)	Name	Description	Default (Range)
F03.61 (0x033D) RUN	High-frequency injection voltage	V/F SVC FVC PMVF PMSVC PMFVC Set the high-frequency injection voltage.	10.0% (0.0%~100.0%)

Note: The set point of 100% corresponds to the motor rated voltage. Generally, there is no need to change this set point after Auto-tuning.

◇ **F03.62: Cutoff Frequency of High-Frequency Injection**

Parameter Code (Address)	Name	Description	Default (Range)
F03.62 (0x033E) RUN	High-frequency injection cutoff frequency	V/F SVC FVC PMVF PMSVC PMFVC Set the cutoff frequency of the high-frequency injection.	10.0% (0.0%~20.0%)

High-frequency injection is Valid when the high-frequency injection action range, motor relative rated frequency, and motor speed are less than this value.

Group F03.7x: Position Compensation

The motor Start can be positioned accurately after the position compensation is enabled.

◇ F03.70: Position Compensation Control

Parameter Code (Address)	Name	Description	Default (Range)
F03.70 (0x0346) RUN	Position compensation control	V/F SVC FVC PMVF PMSVC PMFVC Set the position compensation control. 0:OFF 1:ON	50.0 (0.0~100.0)

◇ F03.71: Position Compensation Gain

Parameter Code (Address)	Name	Description	Default (Range)
F03.71 (0x0347) RUN	Position compensation gain	V/F SVC FVC PMVF PMSVC PMFVC Set the position compensation gain.	0.0 (0.0~100.0)

◇ F03.72: Position Compensation Limiting

Parameter Code (Address)	Name	Description	Default (Range)
F03.72 (0x0348) RUN	Position compensation limiting	V/F SVC FVC PMVF PMSVC PMFVC Set the position compensation limiting.	0.0% (0.0%~100.0%)

◇ F03.73: Position Compensation Range

Parameter Code (Address)	Name	Description	Default (Range)
F03.73 (0x0349) RUN	Position compensation range	V/F SVC FVC PMVF PMSVC PMFVC Set the position compensation range.	0.0% (0.0%~100.0%)

Group F03.8x: Extension Control

MTPA Control

The MTPA control is used to optimize the permanent magnet synchronous motor excitation strategy, so as to maximize the motor output/current. In case of a great inductance difference between the permanent motor shafts D and Q, adjust F03.80 to decrease the motor current under the same load; adjust F03.81 to improve the motor running stability. This control function is only available for the closed-loop vector of a synchronous motor.

◇ F03.80: MTPA Gain of Synchronous Motor

Parameter Code (Address)	Name	Description	Default (Range)
F03.80 (0x0350) RUN	MTPA gain of synchronous motor	V/F SVC FVC PMVF PMSVC PMFVC Set the MTPA gain of synchronous motor.	100.0% (0.0%~400.0%)

◇ F03.81: MTPA Filter Time of Synchronous Motor

Parameter Code (Address)	Name	Description	Default (Range)
F03.81 (0x0351) RUN	MTPA Filter time of synchronous motor	V/F SVC FVC PMVF PMSVC PMFVC Set the MTPA filter time of synchronous motor.	1.0ms (0.0ms~100.0ms)

11.6 Group F04: V/F Control

Group F04.0x: V/F Control

V/F Curve

◇ F04.00: V/F Curve Selection

Parameter Code (Address)	Name	Description	Default (Range)
F04.00 (0x0400) STOP	V/F curve selection	V/F SVC FVC PMVF PMSVC PMFVC Set the V/F curve.	0 (0~11)

0: V/F straight line

1-9: 1.1-1.9 power V/F torque drop curves, respectively

10: Square V/F curve

11: Custom V/F curve

Note:

- F04.00 = 11 [V/F curve selection = custom V/F curve], which is set through F04.10 - F04.19.
- Straight line and torque drop curves are shown as follows. V/F torque drop curves are available when the frequency is above 30% of the motor rated frequency.

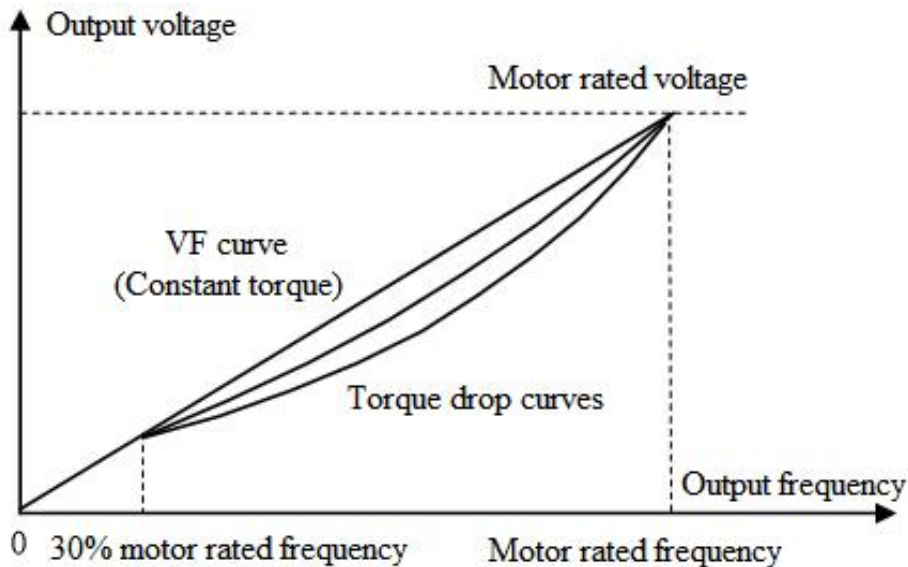

Schematic of V/F Straight Line and Torque Drop Curves

Torque compensation

◇ F04.01: Torque Boost

Parameter Code (Address)	Name	Description	Default (Range)
F04.01 (0x0401) RUN	Torque compensation	V/F SVC FVC PMVF PMSVC PMFVC Set the torque boost.	Model setting (0.0%~30.0%)

0.0: Automatic torque boost to compensate the loss on the stator resistance

Other values: Fixed torque boost

Note:

- When F04.01 = 0.0 [Torque boost = automatic torque boost], the motor output is optimized based on the accurate value of stator resistance obtained through F02.07=3 Auto-tuning.
- The fixed torque boost under V/F straight line and torque drop curves are shown as follows.

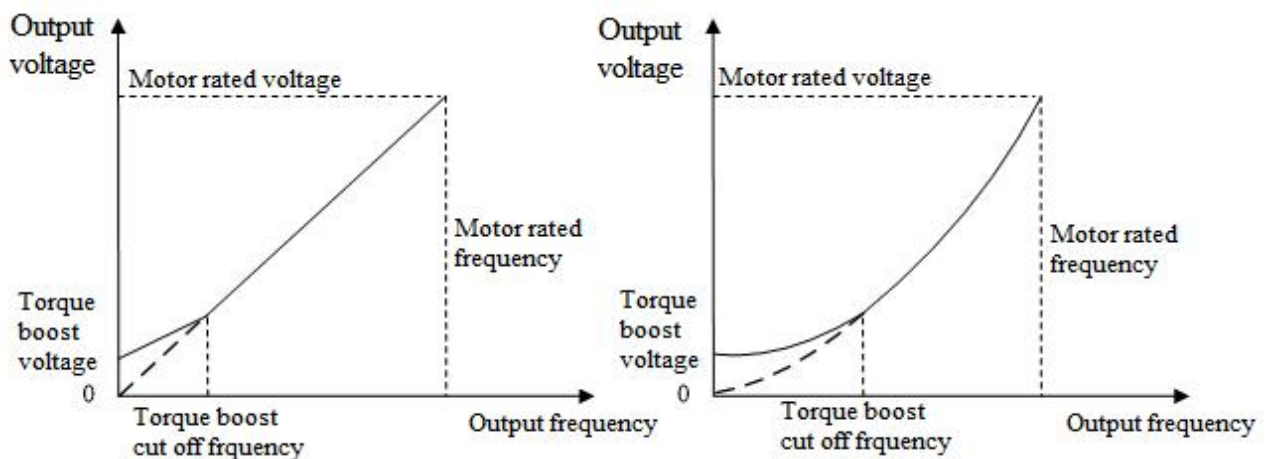

Schematic of Fixed Torque Boost

◇ **F04.02: Torque Boost Cutoff Frequency**

Parameter Code (Address)	Name	Description	Default (Range)
F04.02 (0x0402) RUN	Torque boost cutoff frequency	V/F SVC FVC PMVF PMSVC PMFVC Set the torque boost cutoff frequency.	100.0% (0.0%~100.0%)

Note: The Default of 100% corresponds to the motor rated frequency.

Slip Compensation

This function enables the output frequency of the drive to automatically change with the motor load within the set range to dynamically compensate the motor slip frequency, so as to keep the motor at a constant speed, thus reducing the effect of load variation on the motor speed.

◇ **F04.03: Slip Compensation Gain**

Parameter Code (Address)	Name	Description	Default (Range)
F04.03 (0x0403) RUN	Slip compensation gain	V/F SVC FVC PMVF PMSVC PMFVC Set the slip compensation gain.	0.0% (0.0%~200.0%)

◇ **F04.04: Slip Compensation Limiting**

Parameter Code (Address)	Name	Description	Default (Range)
F04.04 (0x0404) RUN	Slip compensation limiting	V/F SVC FVC PMVF PMSVC PMFVC Set the slip compensation limiting.	100.0% (0.0%~300.0%)

Note: The set point of 100% corresponds to the rated slip frequency.

◇ **F04.05: Slip Compensation Filter Time**

Parameter Code (Address)	Name	Description	Default (Range)
F04.05 (0x0405) RUN	Slip compensation filter time	V/F SVC FVC PMVF PMSVC PMFVC Set the slip compensation filter time.	0.200s (0.000s~6.000s)

Oscillation Suppression

Motor current instability or speed oscillation may occur in medium- and high-power application scenarios. This low-frequency resonance is caused by the electrical and mechanical factors, and low-power motor oscillation is slight. Adjust F04.06 and F04.07 to suppress low-frequency resonance, and gradually increase the oscillation suppression gain value while maintaining stability.

◇ **F04.06: Oscillation Suppression Gain**

Parameter Code (Address)	Name	Description	Default (Range)
F04.06 (0x0406) RUN	Oscillation suppression gain	V/F SVC FVC PMVF PMSVC PMFVC Set the oscillation suppression gain.	100.0% (0.0%~900.0%)

◇ **F04.07: Oscillation Suppression Filter Time**

Parameter Code (Address)	Name	Description	Default (Range)
F04.07 (0x0407) RUN	Oscillation suppression filter time	V/F SVC FVC PMVF PMSVC PMFVC Set the oscillation suppression filter time.	1.0s (0.0s~100.0s)

V/F Output Voltage Ratio

◇ F04.08: Output Voltage Percentage

Parameter Code (Address)	Name	Description	Default (Range)
F04.08 (0x0408) STOP	Output voltage percentage	V/F SVC FVC PMVF PMSVC PMFVC Set the output voltage percentage. 100% corresponds to the motor rated voltage.	100.0% (25.0%~120.0%)

Group F04.1x: Custom V/F Curve

There are 5 adjustable stages of V/F ratio to meet the V/F requirements of different motors.

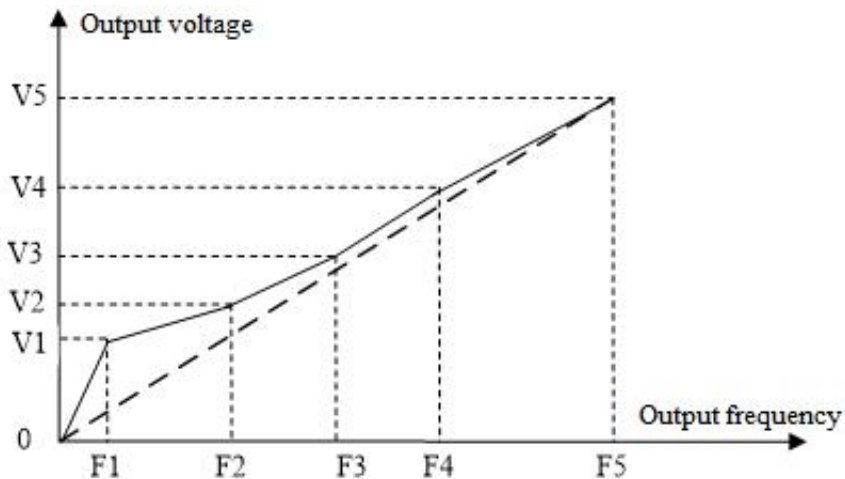

Schematic of Custom Curves

◇ F04.10: Self-Setting Voltage 1

Parameter Code (Address)	Name	Description	Default (Range)
F04.10 (0x040A) STOP	Self-setting voltage 1	V/F SVC FVC PMVF PMSVC PMFVC Set the self-setting voltage 1. The set point of 100.0% corresponds to the motor rated voltage.	3.0% (0.0%~100.0%)

◇ F04.11: Self-Setting Frequency 1

Parameter Code (Address)	Name	Description	Default (Range)
F04.11 (0x040B) STOP	Self-setting frequency 1	V/F SVC FVC PMVF PMSVC PMFVC Set the self-setting frequency 1.	1.00Hz (0.00Hz~F01.10)

◇ F04.12: Self-Setting Voltage 2

Parameter Code (Address)	Name	Description	Default (Range)
F04.12 (0x040C) STOP	Self-setting voltage 2	V/F SVC FVC PMVF PMSVC PMFVC Set the self-setting voltage 2. The set point of 100.0% corresponds to the motor rated voltage.	28.0% (0.0%~100.0%)

◇ **F04.13: Self-Setting Frequency 2**

Parameter Code (Address)	Name	Description	Default (Range)
F04.13 (0x040D) STOP	Self-setting frequency 2	V/F SVC FVC PMVF PMSVC PMFVC Set the self-setting frequency 2.	10.00Hz (0.00Hz~F01.10)

◇ **F04.14: Self-Setting Voltage 3**

Parameter Code (Address)	Name	Description	Default (Range)
F04.14 (0x040E) STOP	Self-setting voltage 3	V/F SVC FVC PMVF PMSVC PMFVC Set the self-setting voltage 3. The set point of 100.0% corresponds to the motor rated voltage.	55.0% (0.0%~100.0%)

◇ **F04.15: Self-Setting Frequency 3**

Parameter Code (Address)	Name	Description	Default (Range)
F04.15 (0x040F) STOP	Self-setting frequency 3	V/F SVC FVC PMVF PMSVC PMFVC Set the self-setting frequency 3.	25.00Hz (0.00Hz~F01.10)

◇ **F04.16: Self-Setting Voltage 4**

Parameter Code (Address)	Name	Description	Default (Range)
F04.16 (0x0410) STOP	Self-setting voltage 4	V/F SVC FVC PMVF PMSVC PMFVC Set the self-setting voltage 4. The set point of 100.0% corresponds to the motor rated voltage.	78.0% (0.0%~100.0%)

◇ **F04.17: Self-Setting Frequency 4**

Parameter Code (Address)	Name	Description	Default (Range)
F04.17 (0x0411) STOP	Self-setting frequency 4	V/F SVC FVC PMVF PMSVC PMFVC Set the self-setting frequency 4.	37.50Hz (0.00Hz~F01.10)

✧ **F04.18: Self-Setting Voltage 5**

Parameter Code (Address)	Name	Description	Default (Range)
F04.18 (0x0412) STOP	Self-setting voltage 5	V/F SVC FVC PMVF PMSVC PMFVC Set the self-setting voltage 5. The set point of 100.0% corresponds to the motor rated voltage.	100.0% (0.0%~100.0%)

✧ **F04.19: Self-Setting Frequency 5**

Parameter Code (Address)	Name	Description	Default (Range)
F04.19 (0x0413) STOP	Self-setting frequency 5	V/F SVC FVC PMVF PMSVC PMFVC Set the self-setting frequency 5.	50.00Hz (0.00Hz~F01.10)

Group F04.2x: V/F separation Control

separation control of the output voltage and output frequency.

After the run command is activated, the output voltage and output frequency will change with the set acceleration/deceleration time respectively.

After the stop command is activated, the output voltage and output frequency will change with the set acceleration/deceleration time respectively. The stop mode is selected through F04.24.

Related Parameters:

	Setting Source	Acceleration/ Deceleration Time	Remarks
Frequency	F01.02	F01.22、F01.23	
Voltage	F04.21	F04.22、F04.23	

Note:

- This function is available for T3 models (7.5 kW) and above, as well as T2 models (5.5 kW) and above.
- When the V/F separation control is Valid, the output voltage will be decreased due to over-current suppression.
- After the stop command is Valid, when the output frequency drops below the value specified in F07.11 [Stop Detection Frequency], the drive will be stop.

◇ F04.20: V/F separation Voltage Selection

Parameter Code (Address)	Name	Description	Default (Range)
F04.20 (0x0414) RUN	V/F separation voltage setting	V/F SVC FVC PMVF PMSVC PMFVC LED"0": Channel A LED"00": Channel B 0: Voltage percentage 1: Keypad potentiometer 2:A11 3: AI2 4: Reserved 5: Terminal pulse PUL 6: PID output 7: RS485 communication 8: Option card 9: Voltage value LED"000": Mode 0: Channel A 1: Channel B 2: A + B 3: A - B 4: MIN (A, B) 5: MAX (A, B)	0000 (0000~0599)

◇ F04.21: V/F separation Output Voltage Number Setting

Parameter Code (Address)	Name	Description	Default (Range)
F04.21 (0x0415) RUN	V/F separation output voltage number setting	V/F SVC FVC PMVF PMSVC PMFVC Set the V/F separation voltage value.	0.00% (0.00%~100.00%)

Note: The output is blocked when the output voltage is set as 0%. 100% corresponds to the motor rated voltage.

◇ F04.22: V/F separation Voltage Acceleration/Deceleration Time

Parameter Code (Address)	Name	Description	Default (Range)
F04.22 (0x0416) RUN	V/F separation voltage acceleration time	V/F SVC FVC PMVF PMSVC PMFVC Set the V/F separation voltage acceleration time.	10.00s (0.00s~100.00s)
F04.23 (0x0417) RUN	V/F separation voltage deceleration time	V/F SVC FVC PMVF PMSVC PMFVC Set the V/F separation voltage deceleration time.	10.00s (0.00s~100.00s)

◇ F04.24: V/F separation stop Mode

Parameter Code (Address)	Name	Description	Default (Range)
F04.24 (0x0418) RUN	V/F separation stop mode	V/F SVC FVC PMVF PMSVC PMFVC Set the V/F separation stop mode. 0: The acceleration/deceleration of output voltage is independent of the acceleration/deceleration of output frequency; 1: The output frequency drops again after the output voltage drops to 0 V.	0 (0~1)

◇ **F04.25: Output Voltage Value Setting**

Parameter Code (Address)	Name	Description	Default (Range)
F04.25 (0x0419) RUN	V/F separation voltage value setting	V/F SVC FVC PMVF PMSVC PMFVC Set the V/F separation voltage value.	0.00V (0.00V~600.00V)

Group F04.3x: V/F Energy-Saving Control

When the motor is light-load, the drive will automatically adjust the output voltage after achieving a constant speed to improve motor efficiency and save energy.

◇ **F04.30: Automatic Energy-Saving Control**

Parameter Code (Address)	Name	Description	Default (Range)
F04.30 (0x041E) STOP	Automatic energy-saving control	V/F SVC FVC PMVF PMSVC PMFVC Chooses whether to activate the automatic energy-saving control. 0:OFF 1:ON	0 (0~1)

◇ **F04.31: Lower Limit of Energy-Saving Step-Down Frequency**

Parameter Code (Address)	Name	Description	Default (Range)
F04.31 (0x041F) STOP	Lower limit of the energy-saving step-down frequency	V/F SVC FVC PMVF PMSVC PMFVC Set the lower limit of the energy-saving step-down frequency.	15.00Hz (0.00Hz~50.00Hz)

Note: The drive will automatically exit the energy-saving mode when its output frequency is lower than this value. The value of 100% corresponds to the motor rated frequency.

◇ **F04.32: Lower Limit of Energy-Saving Step-Down Voltage**

Parameter Code (Address)	Name	Description	Default (Range)
F04.32 (0x0420) STOP	Lower limit of the energy-saving step-down voltage	V/F SVC FVC PMVF PMSVC PMFVC Set the lower limit of the energy-saving step-down voltage.	50.0% (20.0%~100.0%)

Note: The set point of 100.0% is the output voltage corresponding to the output frequency when the energy-saving control is invalid.

◇ **F04.33: Regulation Rate of Energy-Saving Step-Down Voltage**

Parameter Code (Address)	Name	Description	Default (Range)
F04.33 (0x0421) RUN	Energy-saving step-down voltage regulation rate	V/F SVC FVC PMVF PMSVC PMFVC Set the energy-saving step-down voltage regulation rate.	0.010V/ms (0.000V/ms~0.200V/ms)

◇ **F04.34: Recovery Rate of Energy-Saving Step-Down Voltage**

Parameter Code (Address)	Name	Description	Default (Range)
F04.34 (0x0422) RUN	Energy-saving voltage recovery rate	V/F SVC FVC PMVF PMSVC PMFVC Set the energy-saving voltage recovery rate.	0.200V/ms (0.000V/ms~ 2.000V/ms)

11.7 Group F05: Input Terminals

Group F05.0x: Digital Input Terminals (X1 - X10)

Function Selection of Terminals X1 - X10

The drive is equipped with 5 multi-functional input terminals (X1 - X5) and 5 multi-functional extension terminals (X6 - X10) obtained through an IO extension card. The factory settings are shown in the table below.

Note: IO extension card is optional.

Code	Name	Default	Function
F05.00	Function selection of terminal X1	1	Forward run command (2-wire control)
F05.01	Function selection of terminal X2	2	Reverse run command (2-wire control)
F05.02	Function selection of terminal X3	4	Forward jogging
F05.03	Function selection of terminal X4	5	Reverse jogging
F05.04	Function selection of terminal X5	6	Free stop
F05.05	Function selection of extension terminal X6	0	No operation
F05.06	Function selection of extension terminal X7	0	No operation
F05.07	Function selection of extension terminal X8	0	No operation
F05.08	Function selection of extension terminal X9	0	No operation
F05.09	Function selection of extension terminal X10	0	No operation

Refer to the table below when setting the functions of F05.0x [Function Selection of Multi-Functional Input Terminals].

Set Point	Function	Set Point	Function
0	No function	34	Acceleration/deceleration halt
1	Forward running	35	Swing frequency on
2	Reverse running	36	Swing frequency halt
3	3-wire control (Xi)	37	Swing frequency reset
4	Forward jogging	38	Selection of Keypad keys and self-test display
5	Reverse jogging	39	X5 or X10 (extension terminal) test frequency
6	Free stop	40	Timer trigger terminal
7	Emergency stop	41	Timer reset terminal
8	Fault reset	42	Counter clock input terminal
9	External fault input	43	Counter reset terminal
10	Frequency UP	44	DC brake command
11	Frequency DW	45	Pre-excitation command terminal
12	Frequency UP/DW/reset	46	Reserved
13	Changeover from Channel A to Channel B	47	Reserved

14	Changing the frequency channel combination to A	48	Changeover of the command channel to Keypad
15	Changing the frequency channel combination to B	49	Changeover of the command channel to terminal
16	Multi-Speed Terminal 1	50	Changeover of the command channel to communication
17	Multi-Speed Terminal 2	51	Changeover of the command channel to extension card
18	Multi-Speed Terminal 3	52	Running disabled
19	Multi-Speed Terminal 4	53	Forward disabled
20	PID control cancel	54	Reverse disabled
21	PID control halt	55~59	Reserved
22	PID characteristic changeover	60	Speed/torque control changeover
23	PID parameter changeover	61	Reserved
24	PID setting changeover 1	62	Torque mode frequency upper limit restriction as per the jog frequency
25	PID setting changeover 2	63~87	Reserved
26	PID setting changeover 3	88	Roll diameter reset.
27	PID feedback changeover 1	89	Initial roll diameter selection terminal 1
28	PID feedback changeover 2	90	Initial roll diameter selection terminal 2
29	PID feedback changeover 3	91	Linear speed selection terminal
30	Program running (PLC) halt	92	Tension setting channel changeover.
31	Program running (PLC) reboot	93	Reserved.
32	Acceleration/deceleration time selection terminal 1	94	Winding/unwinding changeover.
33	Acceleration/deceleration time selection terminal 2	95	Pre-drive terminal.

◇ F05.00: Function Selection of Terminal X1

Parameter Code (Address)	Name	Description	Default (Range)
F05.00 (0x0500) STOP	Function selection of terminal X1	V/F SVC FVC PMVF PMSVC PMFVC Set the function assigned to the multi-functional input terminal X1.	1 (0~95)

◇ F05.01: Function Selection of Terminal X2

Parameter Code (Address)	Name	Description	Default (Range)
F05.01 (0x0501) STOP	Function selection of terminal X2	V/F SVC FVC PMVF PMSVC PMFVC Set the function assigned to the multi-functional input terminal X2.	2 (0~95)

◇ F05.02: Function Selection of Terminal X3

Parameter Code (Address)	Name	Description	Default (Range)
F05.02 (0x0502) STOP	Function selection of terminal X3	V/F SVC FVC PMVF PMSVC PMFVC Set the function assigned to the multi-functional input terminal X3.	4 (0~95)

◇ F05.03: Function Selection of Terminal X4

Parameter Code (Address)	Name	Description	Default (Range)
F05.03 (0x0503) STOP	Function selection of terminal X4	V/F SVC FVC PMVF PMSVC PMFVC Set the function assigned to the multi-functional input terminal X4.	5 (0~95)

◇ F05.04: Function Selection of Terminal X5

Parameter Code (Address)	Name	Description	Default (Range)
F05.04 (0x0504) STOP	Function selection of terminal X5	V/F SVC FVC PMVF PMSVC PMFVC Set the function assigned to the multi-functional input terminal X5.	6 (0~95)

◇ F05.05~F05.09: Function Selection of extension Terminals X6 - X10

Parameter Code (Address)	Name	Description	Default (Range)
F05.05 (0x0505) STOP	Function selection of terminal X6	V/F SVC FVC PMVF PMSVC PMFVC Set the function assigned to the multi-functional input terminal X6.	0 (0~95)
F05.06 (0x0506) STOP	Function selection of terminal X7	V/F SVC FVC PMVF PMSVC PMFVC Set the function assigned to the multi-functional input terminal X7.	0 (0~95)
F05.07 (0x0507) STOP	Function selection of terminal X8	V/F SVC FVC PMVF PMSVC PMFVC Set the function assigned to the multi-functional input terminal X8.	0 (0~95)
F05.08 (0x0508) STOP	Function selection of terminal X9	V/F SVC FVC PMVF PMSVC PMFVC Set the function assigned to the multi-functional input terminal X9.	0 (0~95)
F05.09 (0x0509) STOP	Function selection of terminal X10	V/F SVC FVC PMVF PMSVC PMFVC Set the function assigned to the multi-functional input terminal X10.	0 (0~95)

Set Point of Multi-Function Input

Set the functions assigned to F05.00~F05.09.

0: No function.

It indicates that the terminal is deactivated. When a terminal is idle, it is recommend to set the value as "0" to prevent wrong operation.

1: Forward running

When the run command is set by this terminal, if F05.20 [Terminal Control Mode] is set as "0: 2-wire control 1" and the terminal is activated, the drive runs reversely. Refer to F05.20 [Terminal Control Mode] for the functions of other control modes and F07.03 [Start Protection Selection] for the Start protection characteristics.

2: Reverse running

When the run command is set by this terminal, if F05.20 [Terminal Control Mode] is set as "0: 2-wire control 1" and the terminal is activated, the drive runs reversely. Refer to F05.20 [Terminal Control Mode] for the functions of other control modes and F07.03 [Start Protection Selection] for the Start protection characteristics.

3: 3-Wire control (Xi)

When the run command is set by this terminal, if F05.20 [Terminal Control Mode] is set as "2 (3): 3-wire control 1 (2)", the terminal is a 3-wire control terminal (Xi). Refer to F05.20 [Terminal Control Mode] for details; meanwhile, the Start protection characteristics are deactivated. Refer to F07.03 [Start Protection Selection] for details.

4: Forward jogging

5: Reverse jogging

When the forward/reverse jog command input terminal is activated, the drive jogs. The terminal jog command is given top priority. Refer to F07.3x [Jogging Parameter Group] for detailed jog setting parameters and F07.03 [Start Protection Selection] for jog protection characteristics.

6: Free stop

When this terminal is activated, the drive will block the output immediately, and the motor runs freely.

When this terminal remains activated, the drive will remain stop and reject any Start command.

When the keyboard, RS485 communication, option card and terminals run in the 3-wire control mode, the original run command will not resume after the free stop terminal command is deactivated. To start the drive, enter the run command again.

7: Emergency stop

If an emergency stop command is entered during the running process of the drive, the drive will decelerate as per the deceleration time set through F05.27 [Deceleration Time of Emergency stop by Terminal] until stop.

After entering the emergency stop command, the drive cannot restart until it shuts down completely. If F07.10 [stop Mode] is set as free stop, the drive will stop as per the free mode.

When the emergency stop terminal remains activated, the drive will remain stop and reject any Start command. When the emergency stop terminal runs in the 2-wire control mode, for whether the original run command resumes after the emergency stop terminal command is deactivated, refer to F07.03 [Start Protection Selection].

When the keyboard, communication, option card and terminals run in the 3-wire control mode, the original run command will not resume after the emergency stop terminal command is deactivated. To start the drive, please enter the run command again.

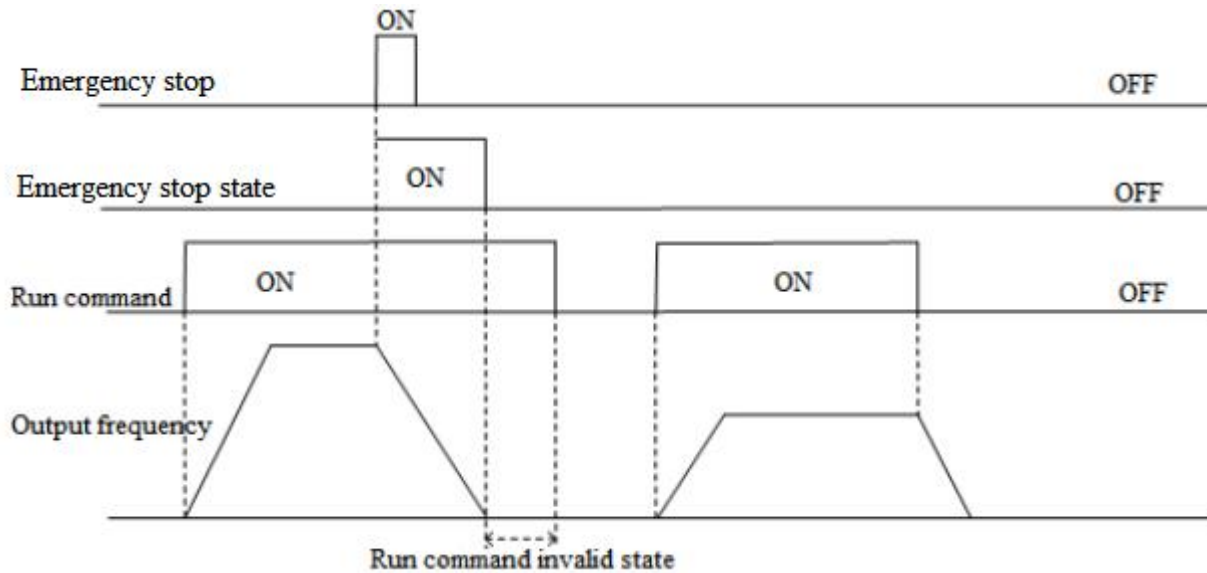

Schematic of Emergency Stop Command

Note: Sudden deceleration may lead to the overvoltage fault of the drive. In case of an overvoltage fault, the drive output will be cut off and the motor will run freely and out of control. Therefore, before the emergency stop, set a proper deceleration time through F05.27 [Terminal Emergency stop Deceleration Time], or activate the regenerative braking function.

8: Fault reset

In case of a fault alarm of the drive, the fault can be reset through the fault reset terminal. When the fault reset terminal runs in the 2-wire control mode, for whether the original run command resumes after the fault is reset, refer to the set point of parameter F07.03 [Start Protection Selection].

9: External fault input

Input the fault signal of external equipment through the external fault input terminal to facilitate the drive to provide fault monitoring and protection for the external equipment. After receiving the external fault input signal, the drive will block the output immediately, and the motor will run freely, displaying the fault code E. EF.

10: Frequency UP

11: Frequency DW

Increase or decrease the frequency by controlling the frequency UP/DW terminal. The terminal UP/DW control is available only when parameter F01.02 [Frequency Setting Source Channel A] is set as "7".

Set the memory and reset mode after UP/DW frequency adjustment through F05.25 [Terminal UP/DW Control Selection]. Refer to F05.25 [Terminal UP/DW Control Selection] for details.

Set the acceleration/deceleration rate of the terminal UP/DW control frequency through F05.26 [Acceleration/Deceleration Rate of Terminal UP/DW Control Frequency]. Refer to F05.26 [Acceleration/Deceleration Rate of Terminal UP/DW Control Frequency] for details.

12: Frequency UP/DW reset

Reset the frequency UP/DW through the "frequency UP/DW reset" terminal at any time.

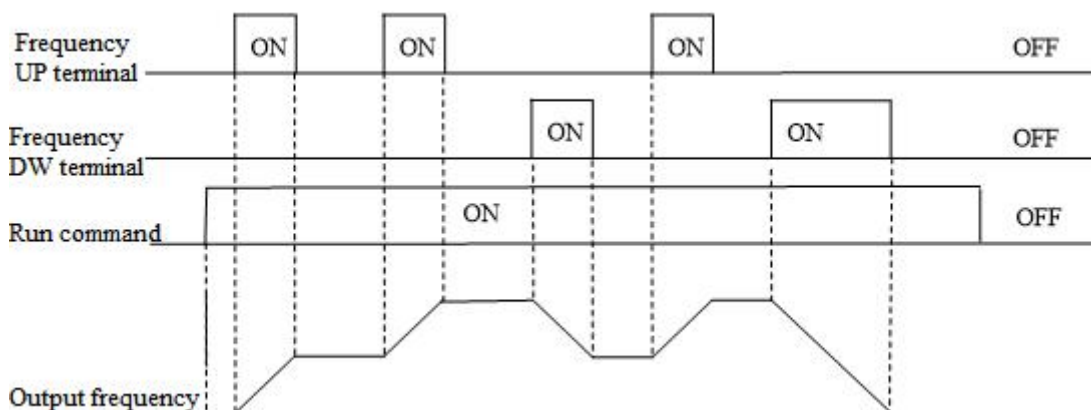

Schematic of Terminal UP/DW Frequency

13: Changeover from Channel A to Channel B**14: Changing the frequency channel combination to A****15: Changing the frequency channel combination to B**

Switch the set frequency channel combination through the terminal.

16: Multi-speed terminal 1**17: Multi-speed terminal 2****18: Multi-speed terminal 3****19: Multi-speed terminal 4**

The input terminal of the multi-speed command can provide 15 stages of speed for selection through code combination. The Multi-speed command is second to the jog command in priority.

20: PID control cancel

When the PID control cancel terminal is activated, it disables the process PID, and force the PID output and internal state to reset; when it is deactivated, PID calculates from the beginning.

21: PID control halt

When the PID control halt terminal is activated, it halts the process PID, and the PID output and internal state remain at the current level; when it is deactivated, PID continues to calculate based on the current value.

22: PID characteristic changeover

When this terminal is activated, the PID feedback characteristic set by the ones place of parameter F13.07 [PID Control Selection] will change; when it is deactivated, the PID output characteristic restores to the PID feedback characteristic set by the ones place of F13.07 [PID Control Selection].

23: PID parameter changeover

This terminal is only activated when F13.17 [PID Parameter Changeover Condition] is set as "1". The PID adjustment proportion, integral and differential parameters are subject to F13.11 - F13.13 [Proportion, Integral, Differential Parameter 1] when the terminal is deactivated and F13.14 - F13.16 [Proportion, Integral, Differential Parameter 1] when the terminal is activated.

24: PID setting changeover 1**25: PID setting changeover 2****26: PID setting changeover 3**

When F13.00 [PID Controller Signal Source] is set as "8: selects by terminal", switch the channel of the PID controller signal source through this set of terminals. Refer to F13.00 [PID Controller Signal Source] for details.

27: PID feedback changeover 1**28: PID feedback changeover 2****29: PID feedback changeover 3**

When F13.03 [PID Controller Feedback Signal Source] is set as "8: selects by terminal", switch the channel of the PID controller feedback signal source through this set of terminals. Refer to F13.03 [PID Controller Feedback Signal Source] for details.

30: Program run (PLC) halt

When F01.02 [Frequency Setting Source Channel A] is set as "9: PLC setting" and the signal is activated, the program will halt and the drive will run at the current frequency; when the signal is deactivated, the program and drive will resume the pre-stop state. Refer to group F14 [Multi-Speed and PLC Functions] for detailed PLC parameters.

31: Program run (PLC) reboot

When F01.02 [Frequency Setting Source Channel A] is set as "9: PLC setting" and the signal is activated, the program will reboot and run from the first stage during stop and program running. Refer to group F14 [Multi-Speed and PLC Functions] for detailed PLC parameters.

32: Acceleration/deceleration time selection terminal 1**33: Acceleration/deceleration time selection terminal 2**

The input terminal of the acceleration/deceleration time selection command can provide 4 stages of acceleration/deceleration

selection through code combination. When the parameter is not set or the terminal is deactivated, the acceleration/deceleration time is set as "1: activated" by default. Refer to F01.24 - F01.29 [Acceleration/Deceleration Time 2, 3 and 4] for details.

34: Acceleration/deceleration halt

When this terminal is activated during drive running, the drive will halt the acceleration/deceleration and maintain the current speed.

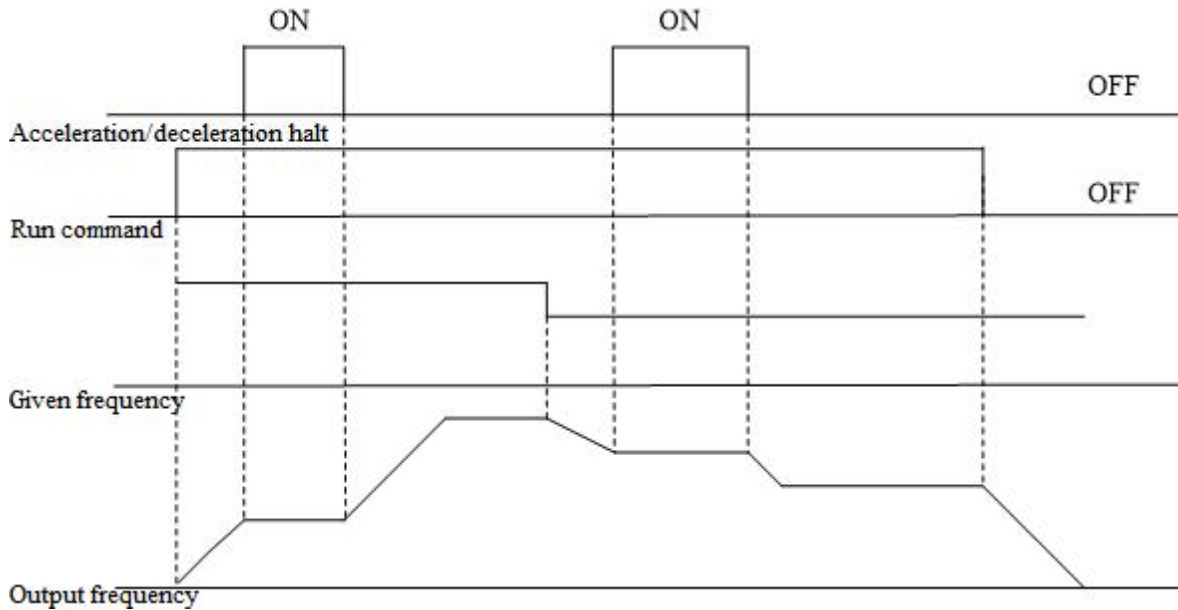

Schematic of Acceleration/Deceleration Halt

35: Swing frequency on

Under swing frequency control, if the input mode is set as manual and this terminal is Valid, the swing frequency control will be Valid and the drive will run at the swing frequency. Refer to F08.3x [Swing Frequency Control Parameter Group] for details.

36: Swing frequency halt

Under swing frequency control, when this terminal is Valid, the drive will maintain the current output frequency. The drive will resume the swing frequency running after the terminal command is Invalid. Refer to F08.3x [Swing Frequency Control Parameter Group] for details.

37: Swing frequency reset

Under swing frequency control, when an effective edge is generated for this terminal, the drive will run at the original swing frequency first and then restart running at the swing frequency. Refer to F08.3x [Swing Frequency Control Parameter Group] for details.

38: Keypad self-test

When this input terminal is Valid, the Keypad will enter the self-test interface.

39: Test frequency selection

Change the characteristic of terminal X5 on the control board or terminal X10 on the extension card to high-speed pulse port as the PUL input port.

40: Timer trigger terminal

Start the timer port for counting, and the timing is triggered when this terminal is activated. Refer to parameters F08.07 [Timer Time Unit] and F08.08 [Timer Set Point] for details.

41: Timer reset terminal

The timer will reset when this terminal is activated. Refer to parameters F08.07 [Timer Time Unit] and F08.08 [Timer Set Point] for details.

42: Counter clock input terminal

This is a clock input terminal with the counter function. Refer to parameters F08.02 [Counter Maximum Value] and F08.03 [Counter Set Point] for details.

43: Counter reset terminal

The counter will reset when this terminal is activated. Refer to parameters F08.02 [Counter Maximum Value] and F08.03 [Counter Set Point] for details.

44: DC braking command

This command can enable the DC braking when the drive is stop. Refer to F07.23 [DC Braking Current] for DC braking current set point. Disable the DC braking by entering the run command or jog command. When the drive is stop, activate this terminal to brake the drive with the pre-start DC braking; when the drive is running, activate the terminal to brake the drive with the stop DC braking.

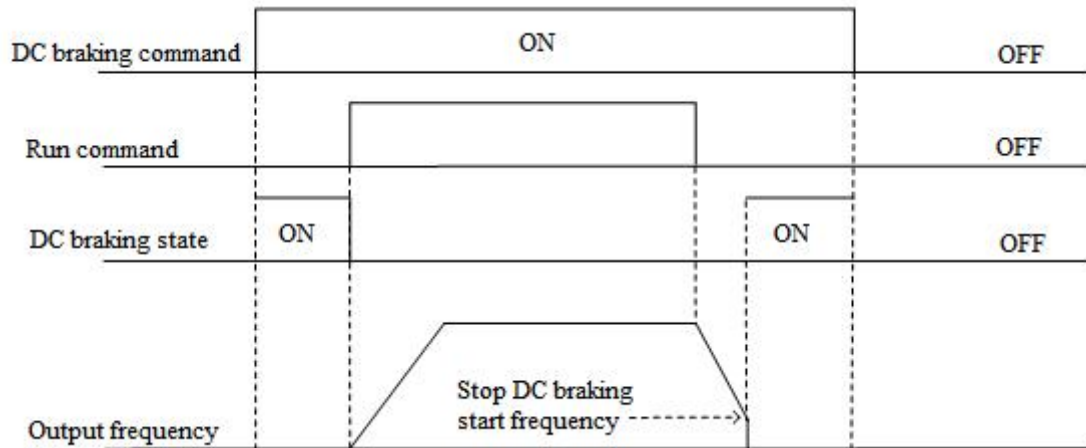

Schematic of DC Braking Command

45: Pre-excitation command terminal

This function can be activated only under the vector control of an asynchronous motor, and can enable the pre-excitation when the drive is stop. Disable the pre-excitation by entering the run command or jog command.

46-47: Reserved

48: Changeover of the command channel to Keypad

49: Changeover of the command channel to terminal

50: Changeover of the command channel to communication

51: Changeover of the command channel to extension card

There are 4 command channel terminals for the changeover (in the order of priority): Keypad, terminal, communication and extension card.

Note: When two command channel terminals are activated at the same time, keyboard is selected by default.

52: Running disabled

When this terminal is activated, the run command is deactivated during stop, and the drive will free stop during running.

53: Forward disabled

When this terminal is activated, the forward run command is deactivated during stop, and the drive will free stop during forward running.

54: Reverse disabled

When this terminal is activated, the reverse run command is deactivated during stop, and the drive will free stop during reverse running.

55-59: Reserved

60: Speed/torque control changeover

This function is activated only under the vector control. When this terminal is activated, the motor is switched from speed control to torque control.

61: Reserved

62: Torque mode frequency upper limit restriction as per the jog frequency

When this terminal is activated, the torque control forward/reverse speed limit is not determined by F03.54 - F04.57, but by F07.30 [Jog Frequency Setting].

63-87: Reserved

88: Roll diameter reset

When this terminal is activated, the roll diameter under tension control will reset to 0.

89: Initial roll diameter selection terminal 1

Under tension control, when F16.47 [Initial Roll Diameter Source] is set as "0: selection by terminal", the initial roll diameter is jointly determined by this function and "90: initial roll diameter selection terminal 2". Refer to the function codes F16.48 - F16.50 [Initial Roll Diameter] for details.

90: Initial roll diameter selection terminal 2

Under tension control, when F16.47 [Initial Roll Diameter Source] is set as "0: selection by terminal", the initial roll diameter is jointly determined by this function and "89: initial roll diameter selection terminal 1". Refer to the function codes F16.48 - F16.50 [Initial Roll Diameter] for details.

91: Linear speed selection terminal

Under tension control, when F16.56 [Linear Speed Input Source] is set as "0: F16.60/F16.61 terminal selection", the linear speed is F16.60 [Linear Speed Set Point 1] when the terminal is Invalid and F16.61 [Linear Speed Set Point 2] when the terminal is Valid.

92: Tension channel changeover

During stop, switch the set tension channel through this terminal. The tension is applied through the tension channel set by the LED"0" by default when this terminal is Invalid and through the tension channel set by the LED"00" when this terminal is Valid. Refer to the function code F16.03 [Tension Setting Selection] for details.

93: Reserved

94: Winding/unwinding changeover

Under tension control, switch between the winding/unwinding mode through this terminal when F16.02 [Winding Mode Setting] is set as "2: selection by terminal". The drive runs in the winding/unwinding mode when the terminal is Invalid/Valid.

95: Pre-drive terminal

When this terminal is Valid/Invalid, the pre-drive under tension control is disabled/enabled.

Group F05.1x: Terminals X1~X5 Detection Delay

◇ **F05.10~F05.11: Terminal X1 Detection Delay**

Parameter Code (Address)	Name	Description	Default (Range)
F05.10 (0x050A) RUN	X1 valid detection delay	V/F SVC FVC PMVF PMSVC PMFVC The delay time taken by terminal X1 from invalid to valid.	0.010s (0.000s~6.000s)
F05.11 (0x050B) RUN	X1 invalid detection delay	V/F SVC FVC PMVF PMSVC PMFVC The delay time taken by terminal X1 from valid to invalid.	0.010s (0.000s~6.000s)

Note:

- Increase the terminal X1 detection delay to enhance the filter effect on the input terminal signal.
- The output terminal X1 corresponding to the monitor record takes the value after the delay of F05.10 [X1 Activation Detection Delay] and F05.11 [X1 Deactivation Detection Delay].
- The output terminal X1 corresponding to the fault record takes the value after the delay of F05.10 [X1 Activation Detection Delay] and F05.11 [X1 Deactivation Detection Delay].
- F05.12 [X2 Activation Detection Delay] - F05.19 [X5 Deactivation Detection Delay] are same as F05.10 [X1 Activation Detection Delay] and F05.11 [X1 Deactivation Detection Delay].

◇ F05.12~F05.13: Terminal X2 Detection Delay

Parameter Code (Address)	Name	Description	Default (Range)
F05.12 (0x050C) RUN	X2 valid detection delay	V/F SVC FVC PMVF PMSVC PMFVC The delay time taken by terminal X2 from invalid to valid.	0.010s (0.000s~6.000s)
F05.13 (0x050D) RUN	X2 invalid detection delay	V/F SVC FVC PMVF PMSVC PMFVC The delay time taken by terminal X2 from valid to invalid.	0.010s (0.000s~6.000s)

Note:

- Increase the terminal X2 detection delay to enhance the filter effect on input terminal signal.

◇ F05.14~F05.15: Terminal X3 Detection Delay

Parameter Code (Address)	Name	Description	Default (Range)
F05.14 (0x050E) RUN	X3 valid detection delay	V/F SVC FVC PMVF PMSVC PMFVC The delay time taken by terminal X3 from invalid to valid.	0.010s (0.000s~6.000s)
F05.15 (0x050F) RUN	X3 invalid detection delay	V/F SVC FVC PMVF PMSVC PMFVC The delay time taken by terminal X3 from valid to invalid.	0.010s (0.000s~6.000s)

Note:

- Increase the terminal X3 detection delay to enhance the filter effect on the input terminal signal.

◇ F05.16~F05.17: Terminal X4 Detection Delay

Parameter Code (Address)	Name	Description	Default (Range)
F05.16 (0x0510) RUN	X4 valid detection delay	V/F SVC FVC PMVF PMSVC PMFVC The delay time taken by terminal X4 from invalid to valid.	0.010s (0.000s~6.000s)
F05.17 (0x0511) RUN	X4 invalid detection delay	V/F SVC FVC PMVF PMSVC PMFVC The delay time taken by terminal X4 from valid to invalid.	0.010s (0.000s~6.000s)

Note:

➤ Increase the terminal X4 detection delay to enhance the filter effect on the input terminal signal.

◇ F05.18~F05.19: Terminal X5 Detection Delay

Parameter Code (Address)	Name	Description	Default (Range)
F05.18 (0x0512) RUN	X5 valid detection delay	V/F SVC FVC PMVF PMSVC PMFVC The delay time taken by terminal X5 from invalid to valid.	0.010s (0.000s~6.000s)
F05.19 (0x0513) RUN	X5 invalid detection delay	V/F SVC FVC PMVF PMSVC PMFVC The delay time taken by terminal X5 from valid to invalid.	0.010s (0.000s~6.000s)

Note:

➤ Increase the terminal X5 detection delay to enhance the filter effect on the input terminal signal.

Group F05.2x: Digital Input Terminal Action Selection

◇ F05.20: Terminal's Running Control Mode

Parameter Code (Address)	Name	Description	Default (Range)
F05.20 (0x0514) STOP	Terminal control mode	V/F SVC FVC PMVF PMSVC PMFVC Set the mode of terminal to control running.	0 (0~3)

0: 2-wire control 1

The running and direction are jointly controlled. This is the commonly used 2-wire control mode. By Default, the motor forward/reverse running is determined by terminal X1 (forward run)/X2 (reverse run) command, which is shown as follows:

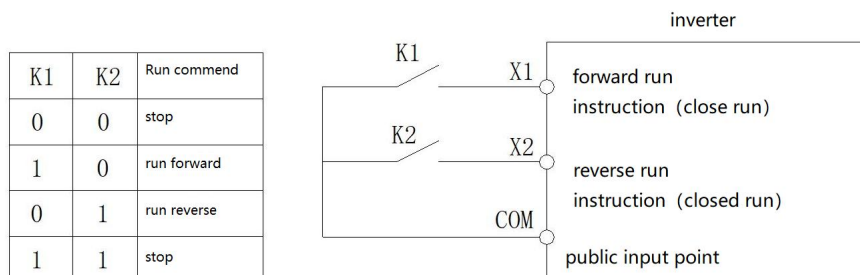

Schematic diagram of two-wire system control 1

1: 2-wire control 2

The running and direction are controlled in a separation way. When using this mode, the running is enabled by the forward run terminal X1. The direction is determined by the reverse run terminal X2. which is shown as follows:

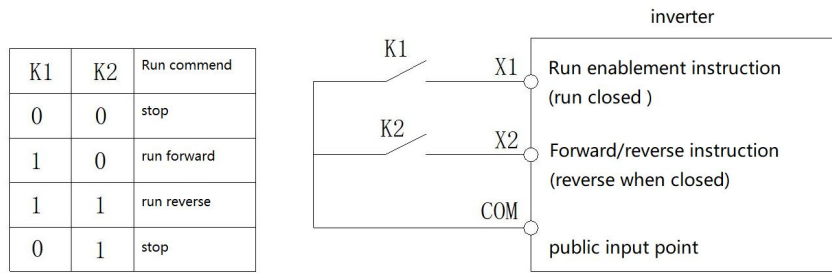

Schematic diagram of two-wire system control 2

2: 3-wire control 1

Under this mode, the 3-wire control terminal (Xi) is a running disable terminal. The run command is produced by the forward run terminal X1, and the direction is controlled by the reverse run terminal X2. The 3-wire control terminal (Xi) is an Valid input terminal.

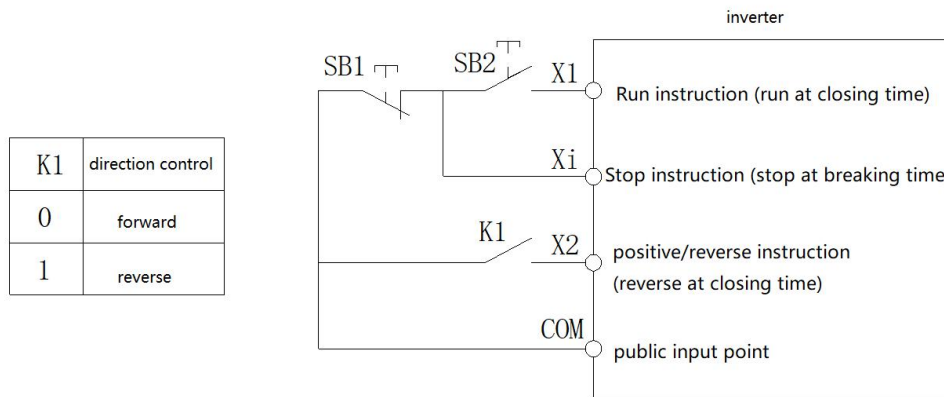

Schematic diagram of three-wire system control 1

3: 3-wire control 2

Under this mode, the 3-wire control terminal (Xi) is a running disable terminal. The run command is produced by the forward run terminal X1 or the reverse run terminal X2, and the direction is controlled by both of them.

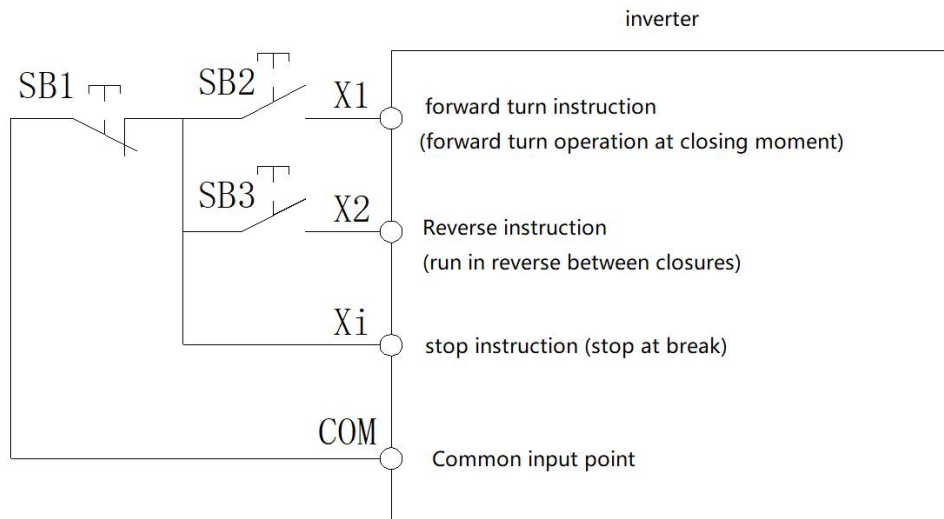

Three-wire system control 2 schematic diagram

Note: SB1: stop button; SB2: forward run button; SB3: reverse run button; "Xi": multi-functional input terminal set as "3" [3-wire control (Xi)].

Note:

➤ When the setting frequency is lower than the Start frequency, the drive will stand by, with the running indicator light on.

✧ **F05.22: Characteristic Selection of Terminals X1 - X4**

Parameter	Name	Description	Default
-----------	------	-------------	---------

Code (Address)			(Range)
F05.22 (0x0516) RUN	Terminal X1-X4 characteristic selection	V/F SVC FVC PMVF PMSVC PMFVC Set terminals X1 - X4 as valid when closed or open.	0000 (0000~1111)

Note: By default, the terminals are Valid when closed. If they are set as Valid when open, note that the open terminals will output closed-loop signals for a while when the drive is powered on.

LED"0": Terminal X1

0: Valid when closed

1: Valid when open

LED"00": Terminal X2

0: Valid when closed

1: Valid when open

LED"000": Terminal X3

0: Valid when closed

1: Valid when open

LED"0000": Terminal X4

0: Valid when closed

1: Valid when open

✧ **F05.23: Characteristic Selection of Terminals X5 - X8**

Parameter Code (Address)	Name	Description	Default (Range)
F05.23 (0x0517) RUN	Terminal X5 - X8 characteristic selection	V/F SVC FVC PMVF PMSVC PMFVC Set terminals X5 - X8 as Valid when closed or open.	0000 (0000~1111)

Note: By default, the terminals are Valid when closed. If they are set as Valid when open, note that the open terminals will output closed-loop signals for a while when the drive is powered on.

LED"0": Terminal X5

0: Valid when closed

1: Valid when open

LED"00": Terminal X6

0: Valid when closed

1: Valid when open

LED"000": Terminal X7

0: Valid when closed

1: Valid when open

LED"0000": Terminal X8

0: Valid when closed

1: Valid when open

✧ **F05.24: Characteristic Selection of Terminals X9 - X10**

Parameter Code (Address)	Name	Description	Default (Range)
--------------------------	------	-------------	-----------------

F05.24 (0x0518) RUN	Terminal X9 - X10 characteristic selection	V/F SVC FVC PMVF PMSVC PMFVC Set terminals X9 - X10 as Valid when closed or open.	0000 (0000~1111)
---------------------------	--	---	---------------------

Note: By default, the terminals are valid when closed. If they are set as valid when open, note that the open terminals will output closed-loop signals for a while when the drive is powered on.

LED"0": Terminal X9

0: Valid when closed

1: Valid when open

LED"00": Terminal X10

0: Valid when closed

1: Valid when open

LED"000": Reserved

LED"0000": Reserved

◇ F05.25: Terminal Frequency Adjustment Mode

Parameter Code (Address)	Name	Description	Default (Range)
F05.25 (0x0519) STOP	Terminal's frequency adjustment mode	V/F SVC FVC PMVF PMSVC PMFVC Set the mode of terminal to adjust frequency UP/DW.	0 (0~2)

Note: This parameter is available when the multi-functional input terminal is set as "10: frequency UP" or "11: frequency DW".

0: Store during power-off/stop

When the terminal switches between frequency UP/DW, the drive will store the frequency record after power-off or stop. When powered on again, the drive will increase/decrease frequency according to the frequency before stop.

1: Reset during power-off, and store during stop

When the terminal switches between frequency UP/DW, the drive will store the frequency record after stop. When turned on again, the drive will increase/decrease frequency according to the frequency before stop. The drive does not store the frequency record after power-off, and will run from the frequency of 0.00 Hz.

2: Valid during running, reset during stop

When the terminal switches between frequency UP/DW, the drive will not store the frequency record after stop or power-off. When turned on again, the drive will increase/decrease frequency from 0.00 Hz.

◇ F05.26: Acceleration/Deceleration Rate of Terminal UP/DW Control Frequency

Parameter Code (Address)	Name	Description	Default (Range)
F05.26 (0x051A) RUN	Acceleration/deceleration rate of the terminal UP/DW control frequency	V/F SVC FVC PMVF PMSVC PMFVC Set the acceleration/deceleration rate of the terminal UP/DW control frequency.	0.50Hz/s (0.01Hz/s~50.00Hz/s)

Note: The acceleration/deceleration rate will increase when the terminal is always Valid.

◇ F05.27: Deceleration Time of Emergency stop by Terminal

Parameter Code (Address)	Name	Description	Default (Range)
F05.27 (0x051B)	Deceleration time of emergency stop	V/F SVC FVC PMVF PMSVC PMFVC Set the deceleration time of emergency stop by the terminal	1.00s (0.01s~650.00s)

RUN	by terminal	command.	
-----	-------------	----------	--

Note: This parameter is available when the multi-functional input terminal is set as "7: emergency stop", the stop mode is set as deceleration, and the emergency stop terminal is Valid.

When the multi-functional input terminal is set as "7: emergency stop", the stop mode is set as free stop, and the emergency stop terminal is Valid, the drive will free stop.

Group F05.3x: Pulse Frequency Input (PUL) Terminal

◇ F05.30: Pulse Frequency Input Signal Selection

Parameter Code (Address)	Name	Description	Default (Range)
F05.30 (0x051E) STOP	Pulse frequency input signal selection	V/F SVC FVC PMVF PMSVC PMFVC Select the mode according to the terminal input signal.	0 (0~2)

0: Terminal X5 is selected for the frequency input with the maximum frequency of 5.000 kHz.

In this mode, parameters F05.31, F05.33 and C00.19 have three decimal places.

1: Extension terminal X10 is selected for the frequency input with the maximum frequency of 100.00 kHz.

In this mode, parameters F05.31, F05.33 and C00.19 have two decimal places.

2: Terminal X5 is selected for the frequency input with the maximum frequency of 100.00 kHz.

In this mode, parameters F05.31, F05.33 and C00.19 have two decimal places.

Note:

- When F05.30 is set as "2", you need to select a customized control board (this is not supported by a universal machine).
- The pulse frequency signal shall have a 50% duty cycle.

◇ F05.31 - F05.34: Linear Processing of PUL Input

Parameter Code (Address)	Name	Description	Default (Range)
F05.31 (0x051F) RUN	Minimum frequency of PUL input	V/F SVC FVC PMVF PMSVC PMFVC Set the minimum frequency value. Any frequency signal below the value will be processed as this value.	0.000kHz (0.000kHz~50.000kHz, F05.30=0) (0.00kHz~100.00kHz, F05.30=1, 2)
F05.32 (0x0520) RUN	Minimum PUL input frequency setting	V/F SVC FVC PMVF PMSVC PMFVC Set the percentage of the set point for the minimum PUL input frequency.	0.00% (0.00%~100.00%)
F05.33 (0x0521) RUN	Maximum frequency of PUL input	V/F SVC FVC PMVF PMSVC PMFVC Set the maximum frequency value. Any frequency signal above the value will be processed as this value.	5.000kHz (0.00kHz~50.000kHz, F05.30=0) (0.00kHz~100.00kHz, F05.30=1, 2)
F05.34 (0x0522) RUN	Maximum PUL input frequency setting	V/F SVC FVC PMVF PMSVC PMFVC Set the percentage of the set point for the maximum PUL input frequency.	100.00% (0.00%~100.00%)

The linear processing of the PUL input frequency is shown as follows:

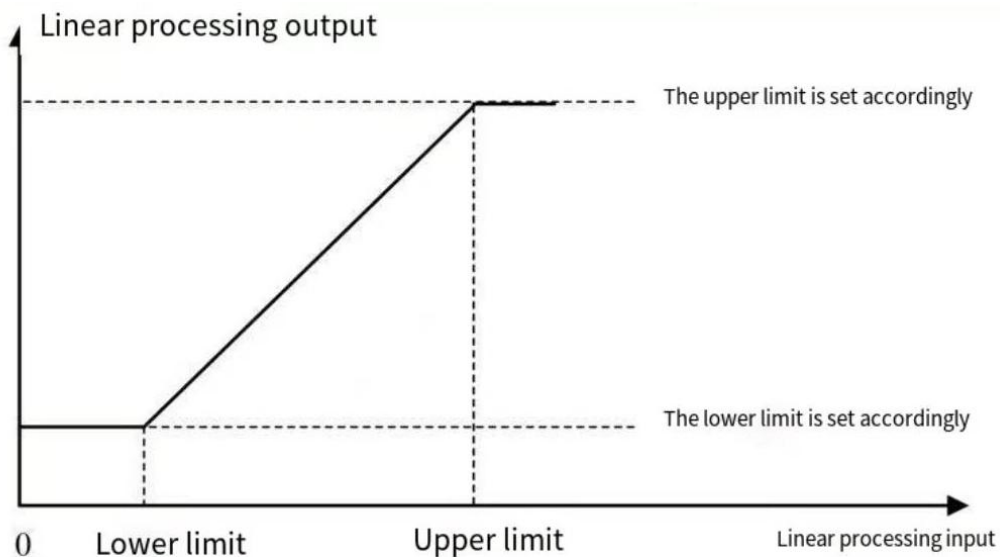

Schematic of Linear Processing of PUL Input Frequency

Note:

- The decimal places of parameters F05.31 and F05.33 are determined by the set point of F05.30.
- The output value of linearly processed PUL is within F05.32 - F05.34. If F01.02 is set as "5: frequency setting Channel A = PUL setting", 100.00% and 0.00% correspond to the maximum frequency and 0.00 Hz, respectively, and the frequency within 0.00% - 100.00% will be linearly processed.

Application selection of PUL input:

Table 11.8 Application Selection of PUL Input

Parameter Code	Name	Set Point
F01.02	Frequency setting Channel A.	5: PUL setting
F01.03	Frequency setting Channel B.	5: PUL setting
F01.08	Run command bound with the set frequency channel.	6: PUL setting
F01.11	Upper frequency limit source selection.	5: PUL setting
F03.41	Torque command setting.	5: PUL setting
F03.54	Torque control forward speed limit selection.	5: PUL setting
F03.55	Torque control reverse speed limit selection.	5: PUL setting
F13.00	Sets the signal source of PID controller.	5: PUL setting
F13.02	Sets the feedback signal source of PID controller.	5: PUL setting

◇ **F05.35: PUL Filter Time**

Parameter Code (Address)	Name	Description	Default (Range)
F05.35 (0x0523) RUN	PUL filter time	V/F SVC FVC PMVF PMSVC PMFVC Set the filter time for input pulse signals.	0.100s (0.000s~9.000s)

Note:

- The longer the filter time, the stronger the anti-interference capability, but the slower the reaction speed.

◇ **F05.36: PUL Cutoff Frequency**

Parameter Code (Address)	Name	Description	Default (Range)
F05.36 (0x0524) RUN	PUL cutoff frequency	V/F SVC FVC PMVF PMSVC PMFVC Set the minimum pulse frequency identified by the PUL port. Any pulse frequency below this value will not be identified by the drive, but processed as "0 Hz".	0.010kHz (0.000kHz~1.000kHz)

Note:

- The lower the set point, the lower the pulse frequency received by the PUL port. However, when pulse frequency disappears at the PUL port, the drive will take longer time to identify the pulse as "0 Hz".
- The PUL input signal will go through the cutoff frequency judgment, PUL linear processing and filter processing.

Group F05.4x: Analog input (AI) Characteristic Selection

There are two lines of AI in the drive, and their input sources are voltage (0 V- 10.0 V) and current (0 mA - 20 mA), respectively. Select the input source according to the signal source through the DIP switch on the control board. The DIP switch is switched to voltage input by Default.

✧ **F05.41: AI1 Input Signal Type**

Parameter Code (Address)	Name	Description	Default (Range)
F05.41 (0x0529) RUN	AI1 signal type	V/F SVC FVC PMVF PMSVC PMFVC Set the AI1 input signal type. 0: Voltage 0 V~10.00 V 1: Current 0 mA~20.00 mA	0 (0~1)

✧ **F05.42: AI2 Input Signal Type**

Parameter Code (Address)	Name	Description	Default (Range)
F05.42 (0x052A) RUN	AI2 signal type	V/F SVC FVC PMVF PMSVC PMFVC Set the AI2 input signal type. 0: Voltage 0 V - 10.00 V 1: Current 0 mA - 20.00 mA	0 (0~1)

✧ **F05.43: AI Curve Selection**

Parameter Code (Address)	Name	Description	Default (Range)
F05.43 (0x052B) RUN	AI curve selection	V/F SVC FVC PMVF PMSVC PMFVC Set the AI curve.	0000 (0000~0022)

LED"0": AI1 curve selection

- 0: Straight line two-point straight line, by Default.
- 1: Curve 1 multi-point curve.
- 2: Curve 2 multi-point curve.

LED"00": AI2 curve selection

- 0: Straight line two-point straight line, by Default.
- 1: Curve 1 multi-point curve.

2: Curve 2 multi-point curve.

Group F05.5x: AI Linear Processing

AI1 is processed as follows: the input signal sampled will be filtered within the time set through F05.54 [AI1 Filter Time], and go through linear processing or curve processing, which is selected through F05.43 [AI Curve Selection] (linear processing by default). AI2 is processed in the same way as AI1.

◇ F05.50 - F05.54: AI1 Linear Processing

Parameter Code (Address)	Name	Description	Default (Range)
F05.50 (0x0532) RUN	AI1 lower limit	V/F SVC FVC PMVF PMSVC PMFVC Set the lower limit of the AI1 sampling per-unit value. Any per-unit value below this value will be processed as this value.	0.0% (0.0%~100.0%)
F05.51 (0x0533) RUN	AI1 lower limit setting	V/F SVC FVC PMVF PMSVC PMFVC Set the percentage of the set point for the AI1 lower limit.	0.00% (-100.00%~100.00%)
F05.52 (0x0534) RUN	AI1 upper limit	V/F SVC FVC PMVF PMSVC PMFVC Set the upper limit of the AI1 sampling per-unit value. Any per-unit value above this value will be processed as this value.	100.0% (0.0%~100.0%)
F05.53 (0x0535) RUN	AI1 upper limit setting	V/F SVC FVC PMVF PMSVC PMFVC Set the percentage of the set point for the AI1 upper limit.	100.00% (-100.00%~100.00%)
F05.54 (0x0536) RUN	AI1 filter time	V/F SVC FVC PMVF PMSVC PMFVC Set the filter time for AI1 input signals. AI1 input signal will be filtered and then linearly processed.	0.100s (0.000s~6.000s)

Note:

- Switch between voltage input (0.0 V - 10.0 V) and current input (0 mA - 20 mA) of the AI1 input through the DIP switch on the control board.
- C00.16 displays the per-unit value of the AI1 input signal sampled by the drive, with the range of 0.0% - 100.0%.
- The AI1 input application value is that after curve processing.
- AI1 input signal is the per-unit value after sampled by the drive.

AI1 Input Signal	Drive Sampling Per-Unit Value
0V~10V	0.0%~100.0%
0mA~20mA	0.0%~100.0%

The linear processing of AI1 is shown as follows:

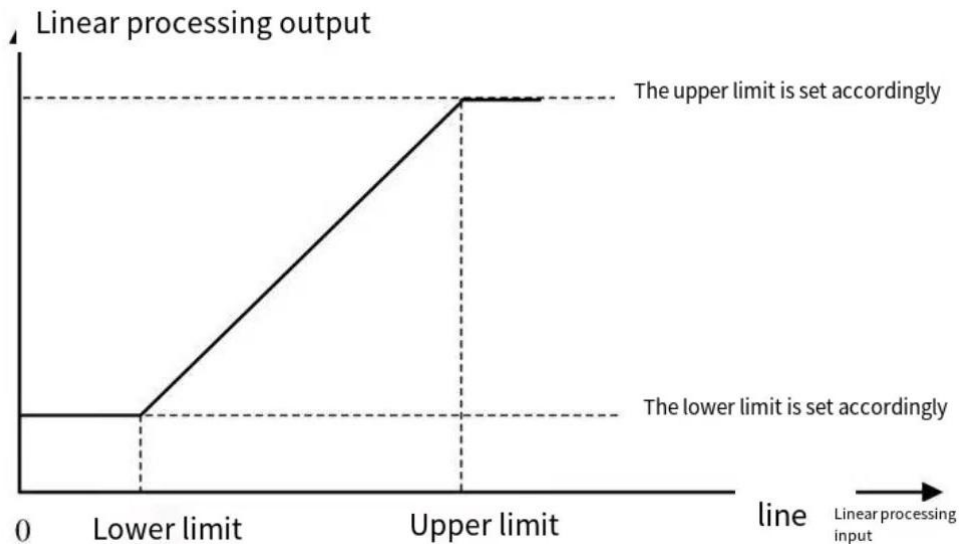

Schematic of AI Linear Processing

Table 11.9 Application Selection of AI1 Input

Parameter Code	Name	Set Point
F01.03	Frequency setting Channel A.	2: AI1 setting
F01.05	Frequency setting Channel B.	2: AI1 setting
F01.08	Run command bound with the set frequency channel.	3: AI1 setting
F01.11	Upper frequency limit source selection.	2: AI1 setting
F03.41	Torque command setting.	2: AI1 setting
F03.54	Torque control forward speed limit selection.	2: AI1 setting
F03.55	Torque control reverse speed limit selection.	2: AI1 setting
F13.00	Set the signal source of PID controller.	2: AI1 setting
F13.02	Set the feedback signal source of PID controller.	2: AI1 setting

◇ F05.55~F05.59: AI2 Linear Processing

Parameter Code (Address)	Name	Description	Default (Range)
F05.55 (0x0537) RUN	AI2 lower limit	V/F SVC FVC PMVF PMSVC PMFVC Set the lower limit of AI2 sampling per-unit value. Any per unit below this value will be processed as this limit.	0.0% (0.0%~100.0%)
F05.56 (0x0538) RUN	AI2 lower limit setting	V/F SVC FVC PMVF PMSVC PMFVC Set the percentage of the set point for the AI2 lower limit.	0.00% (-100.00%~100.00%)
F05.57 (0x0539) RUN	AI2 upper limit	V/F SVC FVC PMVF PMSVC PMFVC Set the upper limit of AI2 sampling per-unit value. Any per unit above this value will be processed as this limit.	100.0% (0.0%~100.0%)
F05.58 (0x053A) RUN	AI2 upper limit setting	V/F SVC FVC PMVF PMSVC PMFVC Set the percentage of the set point for the AI1 upper limit.	100.00% (-100.00%~100.00%)
F05.59 (0x053B) RUN	AI2 filter time	V/F SVC FVC PMVF PMSVC PMFVC Set the filter time for AI2 input signals. AI2 input signal will be filtered and then linearly processed.	0.100s (0.000s~6.000s)

Note:

- Switch between voltage input (0.0V~10.0V) and current input (0mA~20mA) of AI2 input through the DIP switch on the control board.
- C00.17 displays the per-unit value of AI2 input signal sampled by the drive, with the range of 0.0% ~ 100.0%.
- The AI2 input application value is that after curve processing.
- AI2 input signal is the per-unit value of the signal sampled by the drive.

AI2 Input Signal	Drive Sampling Per-Unit Value
0V~10V	0.0%~100.0%
0mA~20mA	0.0%~100.0%

Table 11.10 Application Selection of AI2 Input

Parameter Code	Name	Set Point
F01.03	Frequency setting Channel A.	3: AI2 setting
F01.05	Frequency setting Channel B.	3: AI2 setting
F01.08	Run command bound with the set frequency channel.	4: AI2 setting
F01.11	Upper frequency limit source selection.	3: AI2 setting
F03.41	Torque command setting.	3: AI2 setting
F03.54	Torque control forward speed limit selection.	3: AI2 setting
F03.55	Torque control reverse speed limit selection.	3: AI2 setting
F13.00	Set the signal source of PID controller.	3: AI2 setting
F13.02	Set the feedback signal source of PID controller.	3: AI2 setting

Group F05.6x: AI Curve 1 Processing

The set points of F05.60, F05.62, F05.64 and F05.66 of curve 1 must be set in increasing order.

The set points of F05.70, F05.72, F05.74 and F05.76 of curve 2 must be set in increasing order.

You cannot select curve 1 or curve 2 simultaneously for AI1 and AI2.

Curve 1 and curve 2 can be divided into three straight lines by two inflection points with different slopes to display the corresponding relations more flexibly, as shown in the diagram below:

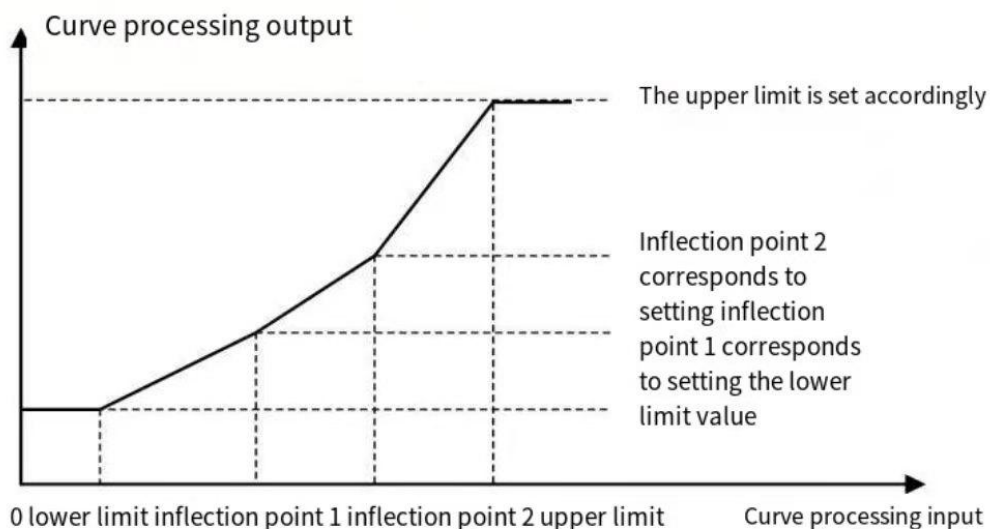

◇ F05.60~F05.67: AI Curve 1 Processing

Parameter	Name	Description	Default
-----------	------	-------------	---------

Code (Address)			(Range)
F05.60 (0x053C) RUN	Curve 1 lower limit	V/F SVC FVC PMVF PMSVC PMFVC Any AI value below this limit will be processed as this value.	0.0% (0.0%~100.0%)
F05.61 (0x053D) RUN	Curve 1 lower limit setting	V/F SVC FVC PMVF PMSVC PMFVC Set the percentage of the set point for the curve 1 lower limit.	0.00% (-100.00%~100.00%)
F05.62 (0x053E) RUN	Inflection point 1 of curve 1	V/F SVC FVC PMVF PMSVC PMFVC Set the value of inflection point 1 of curve 1.	30.0% (0.0%~100.0%)
F05.63 (0x053F) RUN	Setting of inflection point 1 of curve 1	V/F SVC FVC PMVF PMSVC PMFVC Set the percentage of the set point for inflection point 1 of curve 1.	30.00% (-100.00%~100.00%)
F05.64 (0x0540) RUN	Inflection point 2 of curve 1	V/F SVC FVC PMVF PMSVC PMFVC Set the value of inflection point 2 of curve 1.	60.0% (0.0%~100.0%)
F05.65 (0x0541) RUN	Setting of Inflection Point 2 of Curve 1	V/F SVC FVC PMVF PMSVC PMFVC Set the percentage of the set point for inflection point 2 of curve 1.	60.00% (-100.00%~100.00%)
F05.66 (0x0542) RUN	Curve 1 upper limit	V/F SVC FVC PMVF PMSVC PMFVC Any AI value above this limit will be processed as this value.	100.0% (0.0%~100.0%)
F05.67 (0x0543) RUN	Curve 1 upper limit setting	V/F SVC FVC PMVF PMSVC PMFVC Set the percentage of the set point for the curve 1 upper limit.	100.00% (-100.00%~100.00%)

Group F05.7x: AI Curve 2 Processing

◇ F05.70~F05.77: AI Curve 2 Processing

Parameter Code (Address)	Name	Description	Default (Range)
F05.70 (0x0546) RUN	Curve 2 lower limit	V/F SVC FVC PMVF PMSVC PMFVC Any AI value below this limit will be processed as this value.	0.0% (0.0%~100.0%)
F05.71 (0x0547) RUN	Curve 2 lower limit setting	V/F SVC FVC PMVF PMSVC PMFVC Set the percentage of the set point for the curve 2 lower limit.	0.00% (-100.00%~100.00%)
F05.72 (0x0548) RUN	Inflection point 1 of curve 2	V/F SVC FVC PMVF PMSVC PMFVC Set the value of inflection point 1 of curve 2.	30.0% (0.0%~100.0%)
F05.73 (0x0549) RUN	Setting of inflection point 1 of curve 2	V/F SVC FVC PMVF PMSVC PMFVC Set the percentage of the set point for inflection point 1 of curve 2.	30.00% (-100.00%~100.00%)
F05.74 (0x054A) RUN	Inflection point 2 of curve 2	V/F SVC FVC PMVF PMSVC PMFVC Set the value of inflection point 2 of curve 2.	60.0% (0.0%~100.0%)
F05.75 (0x054B) RUN	Setting of inflection point 2 of curve 2	V/F SVC FVC PMVF PMSVC PMFVC Set the percentage of the set point for inflection point 2 of curve 2.	60.00% (-100.00%~100.00%)
F05.76 (0x054C) RUN	Curve 1 upper limit	V/F SVC FVC PMVF PMSVC PMFVC Any AI value above this limit will be processed as this value.	100.0% (0.0%~100.0%)
F05.77 (0x054D) RUN	Curve 2 upper limit setting	V/F SVC FVC PMVF PMSVC PMFVC Set the percentage of the set point for the curve 2 upper limit.	100.00% (-100.00%~100.00%)

Group F05.8x: AI as Digital Input Terminals

Judge high and low levels of AI1 and AI2 according to the input voltage, and use high and low levels to analog digital input terminals. The function selection of AI is the same as that of terminals X1~X10.

◇ F05.80: Characteristic Selection of AI as Digital Input Terminals

Parameter Code (Address)	Name	Description	Default (Range)
F05.80 (0x0550) RUN	Characteristic selection of AI as digital input terminals	V/F SVC FVC PMVF PMSVC PMFVC Set the characteristics of AI as digital input terminals.	00000 (00000~00011)

LED"0": AI1

0: Low level is valid.

1: High level is valid.

LED"00": AI2

0: Low level is valid.

1: High level is valid.

◇ **F05.81:** Function Selection of AI1 as a Digital Input Terminal

Parameter Code (Address)	Name	Description	Default (Range)
F05.81 (0x0551) STOP	Function selection of AI1 as a digital input terminal	V/F SVC FVC PMVF PMSVC PMFVC Set the function of AI1 as a digital input terminal.	0 (0~95)

Note:

- The function selection range of AI1 as a digital input is the same as that of terminals X1 - X10.

◇ **F05.82~F05.83: High/Low Level Setting for AI1**

Parameter Code (Address)	Name	Description	Default (Range)
F05.82 (0x0552) RUN	High level setting for AI1	V/F SVC FVC PMVF PMSVC PMFVC When the sampling per-unit value of AI1 input is higher than this set point, it is the high level.	70.00% (0.00%~100.00%)
F05.83 (0x0553) RUN	Low level setting for AI1	V/F SVC FVC PMVF PMSVC PMFVC When the sampling per-unit value of AI1 input is lower than this set point, it is the low level.	30.00% (0.00%~100.00%)

Note:

- The set point of F05.82 shall be higher than that of F05.83 to distinguish between high and low levels.
- When the AI12 input value is within F05.82~F05.83, a hysteresis judgment will be made according to the previous state to distinguish between high and low levels.

◇ **F05.84:** Function Selection of AI2 as a Digital Input terminal

Parameter Code (Address)	Name	Description	Default (Range)
F05.84 (0x0554) STOP	Function selection of AI2 as a digital input terminal	V/F SVC FVC PMVF PMSVC PMFVC Set the function of AI2 as a digital input terminal.	0 (0~95)

Note:

- The function selection range of AI2 as a digital input is the same as terminals X1~X10.

◇ **F05.85~F05.86: High/Low Level Setting for AI2**

Parameter Code (Address)	Name	Description	Default (Range)
F05.85 (0x0555) RUN	High level setting for AI2	V/F SVC FVC PMVF PMSVC PMFVC When the sampling per unit of AI2 input is higher than this set point, it is the high level.	70.00% (0.00%~100.00%)
F05.86 (0x0556) RUN	Low level setting for AI2	V/F SVC FVC PMVF PMSVC PMFVC When the sampling per unit of AI2 input is lower than this set point, it is the low level.	30.00% (0.00%~100.00%)

Note:

- The set point of F05.85 shall be higher than that of F05.86 to distinguish between high and low levels.
- When the AI2 input value is within F05.85- F05.86, make a hysteresis judgment according to the previous state to distinguish between high and low levels.

11.8 Group F06: Output Terminals

Parameter group F06 is used to set the analog monitoring of the drive, so as to select monitoring items, adjust gain and bias, and select high/low level for output signals.

Group F06.0x: Analog Output (AO) Frequency

Parameter group F06.0x is used to set the analog monitoring of drive, so as to select monitoring items, adjust gain and bias, and select high/low level for output signals.

There is 1 line of AO in the drive. Select among three forms of signal output (voltage, current and frequency) through the DIP switch. Expand 1 line of AO through the optional extension card.

The calibration of instrument connected to multi-functional AO terminals.

Calibrate the instrument connected to the terminal through F06.02, F06.03, F06.04, F06.05 and F06.06.

Parameter	Name	Set Range	Default
F06.00	AO mode selection	0: 0V~10V 1: 4.00mA~20.00mA 2: 0.00mA~20.00mA 3: FM frequency pulse output	0
F06.01	AO quantity selection	0~19	0
F06.02	AO gain	0.0%~300.0%	100.0%
F06.03	AO bias	-10.0%~10.0%	0.0%
F06.04	AO filter	0.000s~6.000s	0.010s
F06.05	AO as lower limit of FM frequency output	0.00kHz~100.00kHz	0.20kHz
F06.06	AO as upper limit of FM frequency output	0.00kHz~100.00kHz	50.00kHz

The effects of gain and bias are shown as follows.

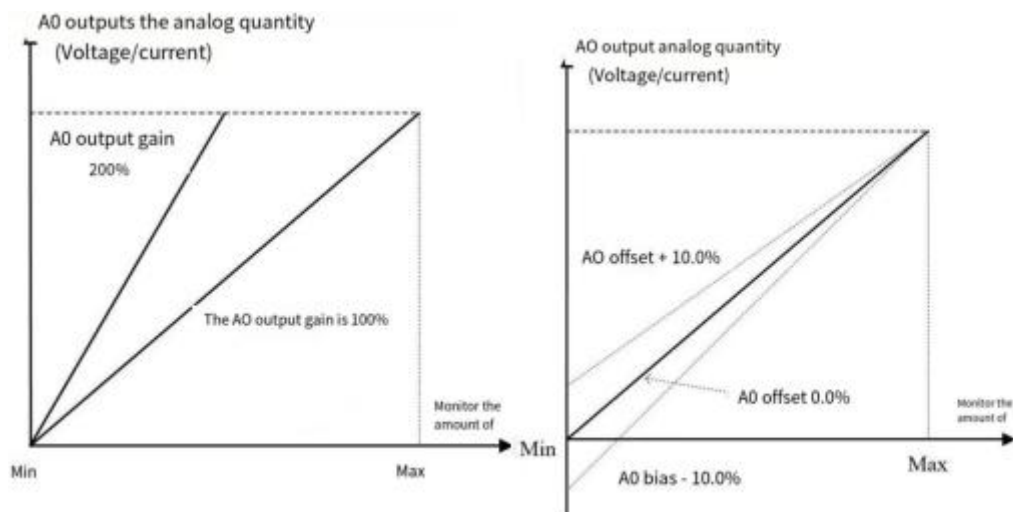

Schematic of AO, Gain and Bias

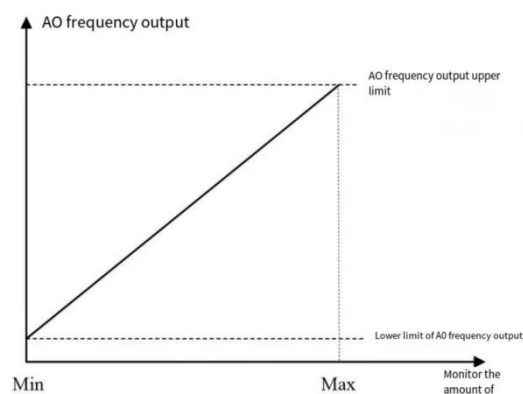

Schematic of AO Pulse Frequency

✧ F06.00: AO Mode Selection

Parameter Code (Address)	Name	Description	Default (Range)
F06.00 (0x0600) RUN	AO mode selection	V/F SVC FVC PMVF PMSVC PMFVC Set the form of AO signals. 0: 0 V~10 V 1: 4.00 mA~20.00 mA 2: 0.00 mA~20.00 mA 3: FM frequency pulse output	0 (0~3)

Note:

➤ To select different modes for F06.00, flip the DIP switch on the control board to the corresponding position.

AO Mode	Position of the DIP Switch on the Control Board
0: 0 V~10 V	Flip AO-U to ON position.
1: 4.00 mA~20.00 mA	Flip AO-I to ON position.
2: 0.00 mA~20.00 mA	Flip AO-I to ON position.
3: FM frequency pulse output	Flip AO-F to ON position.

✧ F06.01: AO Quantity Selection

Parameter Code (Address)	Name	Description	Default (Range)
F06.01 (0x0601) RUN	AO quantity selection	V/F SVC FVC PMVF PMSVC PMFVC Set the AO quantity.	0 (0~19)

Set point and monitoring volume

Set Point	Name	Value Corresponding to 0.00%	Value Corresponding to 100.00%
0	Set frequency	0.00Hz	Maximum frequency.
1	Output Frequency	0.00Hz	Maximum frequency.
2	Output Current	0.00A	Twice the motor rated current.
3	Input Voltage	0.0V	Twice the rated voltage of the drive.
4	Output voltage	0.0V	Motor rated voltage.
5	Mechanical Speed	0rpm	Speed corresponding to the maximum frequency.
6	Set Torque	0.00% of torque	200% of torque.
7	Output Torque	0.00% of torque	200% of torque.
8	PID Set Value	0.00% of PID setting	100% of PID setting.
9	PID Feedback Value	0.00% of PID feedback	100% of PID feedback.
10	Output Power	0 kW	Twice the motor rated output power.
11	Bus Voltage	0 V	Twice the drive rated DC voltage.
12	AI1 input value	AI1 input lower limit	AI1 input upper limit.
13	AI2 input value	AI2 input lower limit	AI2 input upper limit.
14	Reserved		
15	PUL input value	PUL input lower limit	PUL input upper limit.
16	Module Temperature 1	0°C	100°C.
17	Module Temperature 2	0°C	100°C.

18	RS485 communication setting	0	1000.
19	Virtual terminal vY1	Output invalid	Output valid.

Note:

- The rated DC voltage is the drive rated voltage multiplies 1.414.

✧ **F06.02: AO Gain**

Parameter Code (Address)	Name	Description	Default (Range)
F06.02 (0x0602) RUN	AO gain	V/F SVC FVC PMVF PMSVC PMFVC Set the AO gain.	100.0% (0.0%~300.0%)

✧ **F06.03: AO Bias**

Parameter Code (Address)	Name	Description	Default (Range)
F06.03 (0x0603) RUN	AO bias	V/F SVC FVC PMVF PMSVC PMFVC Set the bias of AO signals.	0.0% (-10.0%~10.0%)

✧ **F06.04: AO Filter**

Parameter Code (Address)	Name	Description	Default (Range)
F06.04 (0x0604) RUN	AO filter	V/F SVC FVC PMVF PMSVC PMFVC Sets the filter time of analog output signal.	0.010s (0.000s~6.000s)

✧ F06.05: Setting AO as the FM Output Lower Limit

Parameter Code (Address)	Name	Description	Default (Range)
F06.05 (0x0605) RUN	Setting AO as the FM output lower limit	V/F SVC FVC PMVF PMSVC PMFVC Set AO as the lower limit of the frequency output.	0.20kHz (0.00kHz~100.00kHz)

✧ F06.06: Setting AO as the FM Output Upper Limit

Parameter Code (Address)	Name	Description	Default (Range)
F06.06 (0x0606) RUN	Setting AO as the FM output upper limit	V/F SVC FVC PMVF PMSVC PMFVC Set AO as the upper limit of the frequency output.	50.00kHz (0.00kHz~100.00kHz)

Group F06.1x: Expanded AO

The expanded AO parameter should be used with an option card (IO extension card).

✧ F06.10: Expanded AO Mode Selection

Parameter Code (Address)	Name	Description	Default (Range)
F06.10 (0x060A) RUN	Expanded AO mode selection	V/F SVC FVC PMVF PMSVC PMFVC Set the form of AO signals. 0: 0~10 V mode 1: 4.00~20.00 mA mode 2: 0.00~20.00 mA mode	0 (0~2)

✧ F06.11: Expanded AO Quantity Selection

Parameter Code (Address)	Name	Description	Default (Range)
F06.11 (0x060B) RUN	Expanded AO quantity selection	V/F SVC FVC PMVF PMSVC PMFVC Set the AO quantity. The same as F06.01.	1 (0~19)

✧ F06.12: Expanded AO Gain

Parameter Code (Address)	Name	Description	Default (Range)
F06.12 (0x060C) RUN	Expanded AO gain	V/F SVC FVC PMVF PMSVC PMFVC Set the AO gain.	100.0% (0.0%~300.0%)

◇ F06.13: Expanded AO Bias

Parameter Code (Address)	Name	Description	Default (Range)
F06.13 (0x060D) RUN	Expanded AO bias	V/F SVC FVC PMVF PMSVC PMFVC Set the bias of AO signals.	0.0% (-10.0%~10.0%)

◇ F06.14: Expanded AO Filter

Parameter Code (Address)	Name	Description	Default (Range)
F06.14 (0x060E) RUN	Expanded AO filter	V/F SVC FVC PMVF PMSVC PMFVC Sets the filter time of analog output signal.	0.010s (0.000s~6.000s)

Group F06.2x~F06.3x: Multi-functional Output Terminals

The drive includes one digital output and one relay output, and additional one digital output and one relay output can be expanded through an option card.

Code	Name	Default	Function
F06.21	Output terminal Y.	1	Running.
F06.22	Relay 1 output (TA-TB-TC).	4	Failing.
F06.23	extension output terminal Y1.	0	No output.
F06.24	extension relay 2 output (TA-TB-TC).	0	No output.

Please refer to the table below to set the functions of F06.0x [Function Selection of Multi-functional Output Terminals].

Set Point	Function	Reference Description
0	No output.	Inactive terminal.
1	Drive running	Judge the output according to the running state of the drive.
2	Drive reverse running	
3	Drive forward running	
4	Fault trip alert 2 (no alert during fault self-recovery)	
5	Fault trip alert 2 (no alert during fault self-recovery)	
6	External fault stop	
7	Drive undervoltage	Reserved
8	Drive running preparation completed	Reserved
9	Output frequency detection test 1 (FDT1)	Reserved
10	Output frequency detection test 2 (FDT2)	Reserved
11	Set frequency reached	Reserved
12	Zero-speed running	Reserved
13	Upper frequency limit reached	Reserved
14	Lower frequency limit reached	Reserved
15	Program run cycle completed	Reserved
16	Program run phase completed	Reserved

17	PID feedback upper limit reached	Refer to the description of parameter F13.27.
18	PID feedback lower limit unreached	Refer to the description of parameter F13.28.
19	PID feedback sensor wire broken	Refer to the description of parameter F13.25.
20	Meter length reached	Reserved
21	Timer's set time reached	Reserved
22	Counter's maximum reached	Reserved
23	Counter's set point reached	Reserved
24	Dynamic braking	For the initial voltage of dynamic brake, refer to the description of parameter F10.15.
25	Reserved	
26	Emergency stopping	
27	Overload warning output 1	Refer to the description of parameter F10.32.
28	Underload warning output 2	Refer to the description of parameter F10.32.
29	Drive warning	
30	Output controlled by communication address 0x3018	Refer to the table below.
31	Drive overheat warning	Refer to the description of parameter F10.25.
32~36	Reserved	
37	Comparator 1	Refer to F06.5x monitoring parameter comparator output 1
38	Comparator 2	Refer to F06.5x monitoring parameter comparator output 2
39	Reserved	
40~47	Use of industry application extension.	
48~63	Use of option card.	

Function selection of Modbus RS485 communication to control multi-functional output

Set values of BIT0 - BIT3 (corresponding to output terminals of the controller) in communication address 0x3018. The specific corresponding relationship is as follows:

Communication Address	Name
0x3018	BIT0: Output terminal Y.
	BIT1: Relay 1 output (TA-TB-TC).
	BIT2: extension output terminal Y1.
	BIT3: extension relay 2 output (TA-TB-TC).

◇ **F06.20: Polarity Selection of Multi-functional Output Terminal**

Parameter Code (Address)	Name	Description	Default (Range)
F06.20 (0x0614) RUN	Function selection of output terminal Y	V/F SVC FVC PMVF PMSVC PMFVC Set the function of multi-functional output terminal Y.	0000 (0000~1111)

LED"0": Y terminal

0: Positive polarity, output terminal Y is at low level when Valid, and normally open in an equivalent circuit.

1: Negative polarity, output terminal Y does not output when Valid, and normally open in an equivalent circuit.

LED"00": Relay 1 output terminal

0: Positive polarity, TA-TC is normally open, while TB-TC is normally close.

1: Negative polarity, TA-TC is normally close, while TB-TC is normally open.

LED"000": extension terminal Y

0: Positive polarity, output terminal Y is at low level when Valid, and normally open in an equivalent circuit.

1: Negative polarity, output terminal Y does not output when Valid, and normally open in an equivalent circuit.

LED"0000": Relay 2 output terminal

0: Positive polarity, TA 1-TC 1 is normally open, while TB 1-TC 1 is normally closed.

1: Negative polarity, TA 1-TC 1 is normally closed, while TB 1-TC 1 is normally open.

◇ F06.21: Function Selection of Output Terminal Y

Parameter Code (Address)	Name	Description	Default (Range)
F06.21 (0x0615) RUN	Function selection of output terminal Y	V/F SVC FVC PMVF PMSVC PMFVC Set the function of multi-functional output terminal Y.	1 (0~63)

◇ F06.22: Function Selection of Relay 1

Parameter Code (Address)	Name	Description	Default (Range)
F06.22 (0x0616) RUN	Function selection of relay 1	V/F SVC FVC PMVF PMSVC PMFVC Set the function of the multi-functional output terminal of the relay.	4 (0~63)

Note: When the function of the relay terminal is selected as invalid, TB-TC is normally closed and TA-TC is normally open.

◇ F06.23: Function Selection of Extension Output Terminal Y

Parameter Code (Address)	Name	Description	Default (Range)
F06.23 (0x0617) RUN	Function selection of extension output terminal Y	V/F SVC FVC PMVF PMSVC PMFVC Set the function of multi-functional extension output terminal Y.	0 (0~63)

◇ **F06.24: Function Selection of Extension Relay 2**

Parameter Code (Address)	Name	Description	Default (Range)
F06.24 (0x0618) RUN	Function selection of extension relay 2	V/F SVC FVC PMVF PMSVC PMFVC Sets the function of multi-functional extension output relay 2.	0 (0~63)

Multi-functional output set point

0: No output

It indicates that the terminal is Invalid. If the terminal function is idle, it is recommended to set it to 0 to prevent malfunction.

1: Drive running

When the drive is running, the output terminal will output an activation signal.

2: Drive reverse running

When the drive is operating reversely, the output terminal will output an activation signal.

3: Drive forward running

When the drive is running forward, the output terminal will output an activation signal.

4: Fault trip alert 1 (alert during fault self-recovery)

The output terminal will output signals during a fault of the drive, including the fault self-recovery period.

5: Fault trip alert 2 (no alert during fault self-recovery)

The output terminal will output signals during a fault of the drive, excluding the fault self-recovery period.

6: External fault stop

When the multi-functional input terminal inputs an external fault signal and the drive reports the external fault E. EF, the output terminal will output an activation signal.

7: Drive under-voltage

The output terminal will output an activation signal during under-voltage of the drive.

8: Drive running preparation completed

When this signal is Valid, it indicates that the drive has no fault, the bus voltage is normal, the running disabling terminals such as emergency stop are Invalid, and the drive can run after accepting the Start command.

9: Output frequency detection test 1 (FDT1)

When the output frequency of the drive exceeds the set point of F06.40 [Frequency Detection Value 1], the output terminal will output an activation signal. When the output frequency is lower than the detection level, the output terminal will output a deactivation signal after the hysteresis frequency set by F06.41 [Frequency Detection Range 1]. Refer to parameters F06.40 [Frequency Detection Value 1] and F06.41 [Frequency Detection Range 1] for detailed description.

10: Output frequency detection test 2 (FDT2)

When the output frequency of drive exceeds the set point of F06.42 [Frequency Detection Value 2], the output terminal will output an activation signal. When the output frequency is lower than the detection level, the output terminal will output a deactivation signal after the hysteresis frequency set by F06.43 [Frequency Detection Range 2]. Refer to parameters F06.42 [Frequency Detection Value 2] and F06.43 [Frequency Detection Range 2] for detailed description.

11: Set frequency reached

When the output frequency of the drive approaches or reaches the set frequency range (the range is determined by parameter F06.44 [Detection Range for the Set Frequency Reached]), the output terminal will output an activation signal, otherwise it will output a deactivation signal. Refer to F06.44 [Detection Range for the Set Frequency Reached] for detailed description.

12: Zero-speed running

When the drive is running with output of 0.00 Hz, the output terminal will output an activation signal.

13: Upper frequency limit reached

When the drive is running at the upper limit frequency, the output terminal will output an activation signal.

14: Lower frequency limit reached

When the drive is running at the lower limit frequency, the output terminal will output an activation signal.

15: Program run cycle completed

When the program ends a cycle, the output terminal will output an activation signal of 500 ms.

16: The program run phase completed

When the program ends a phase, the output terminal will output an activation signal of 500 ms.

17: PID feedback upper limit reached

When the PID feedback is detected to reach F13.27 [disconnection Alarm Upper Limit] and the feedback signal keeps exceeding the limit after F13.26 [Feedback disconnection Detection Time], the output terminal will output an activation signal.

18: PID feedback lower limit unreachd

When the PID feedback is detected to reach F13.28 [disconnection Alarm Lower Limit] and the feedback signal keeps exceeding the limit after F13.26 [Feedback disconnection Detection Time], the output terminal will output an activation signal.

19: PID feedback sensor wire broken

When the PID feedback sensor is detected to have a broken wire, the output terminal will output an activation signal. Refer to parameters F13.26 - F13.28 [Feedback disconnection Detection Time], [disconnection Alarm Upper Limit], and [disconnection Alarm Lower Limit].

20: Reserved**21: Timer's set time reached**

When the set time of internal timer of drive is reached, the output terminal will output a valid pulse signal with a width of 1 s. Refer to parameters F08.07 [Timer Time Unit] and F08.08 [Timer Set Point].

22: Counter's maximum reached

When the counter's maximum value is reached, the output terminal will output an activation signal with a width equal to the external clock cycle, and the counter will be reset. Refer to parameter F08.02 [Counter Maximum Value].

23: Counter's set point reached

When the counter's set point is reached, the output terminal will output an activation signal. Then the counter will continue to count until the it is reset after reaching the maximum value, the output activation signal is canceled. Refer to parameter F08.03 [Counter Set Point].

24: Dynamic braking

When the drive meets the dynamic brake conditions, the output terminal will output an activation signal. Refer to parameter F10.14 [Dynamic Brake Enabling] for more details.

25: Reserved**26: Emergency stopping**

When the drive stops for emergency, the output terminal will output an activation signal.

27: Overload warning detection 1

When the drive is running under the V/F control mode, the motor output current will be used as the load warning judgment value; when the drive is running under the vector control mode, the motor output torque will be used as the load warning judgment value. Then the drive will compare the load warning judgment value with the load warning detection level to determine whether to output an activation signal. Refer to parameters F10.32 - F10.36 [Load Warning Detection Setting], [Load Warning Detection Level 1], [Load Warning Detection Time 1], [Load Warning Detection Level 2], and [Load Warning Detection Time 2].

28: Under-load warning detection 2

When the drive is running under the V/F control mode, the motor output current will be used as the load warning judgment value; when the drive is running under the vector control mode, the motor output torque will be used as the load warning judgment value. Then the drive will compare the load warning judgment value with the load warning detection level to determine whether to output an activation signal. Refer to parameters F10.32 - F10.36 [Load Warning Detection Setting], [Load Warning Detection Level 1], [Load Warning Detection Time 1], [Load Warning Detection Level 2], and [Load Warning Detection Time 2].

29: Reserved**30: RS485 communication setting**

After setting through RS485 communication (0x3018/0x2018), BIT0 corresponds to Y output, BIT1 corresponds to relay 1 output, and BIT2 corresponds to relay 2 output.

31: Drive overheat warning

When the temperature of drive reaches F10.25 [Drive Overheat oH1 Warning Detection Level], the output terminal will output an activation signal.

33-36: Reserved

37: Comparator 1

When the value of the monitor item set by F06.50 [Comparator 1 Monitor Selection] is between F06.51 [Comparator 1 Upper Limit] and F06.52 [Comparator 1 Lower Limit], the output terminal will output an activation signal.

38: Comparator 2

When the value of the monitor item set by F06.55 [Comparator 2 Monitor Selection] is between F06.56 [Comparator 2 Upper Limit] and F06.57 [Comparator 2 Lower Limit], the output terminal will output an activation signal.

39-63: Reserved

◇ F06.25 - F06.32: Multi-functional output terminal delay time

Parameter Code (Address)	Name	Description	Default (Range)
F06.25 (0x0619) RUN	Terminal Y ON delay time	V/F SVC FVC PMVF PMSVC PMFVC Set the delay time for terminal Y to switch from OFF to ON.	0.010s (0.000s~60.000s)
F06.26 (0x061A) RUN	Relay 1 terminal ON delay time	V/F SVC FVC PMVF PMSVC PMFVC Set the delay time for terminal Y to switch from OFF to ON.	0.010s (0.000s~60.000s)
F06.27 (0x061B) RUN	extension terminal Y ON delay time	V/F SVC FVC PMVF PMSVC PMFVC Set the delay time for terminal Y to switch from OFF to ON.	0.010s (0.000s~60.000s)
F06.28 (0x061C) RUN	Relay 2 terminal ON delay time	V/F SVC FVC PMVF PMSVC PMFVC Set the delay time for terminal Y to switch from OFF to ON.	0.010s (0.000s~60.000s)
F06.29 (0x061D) RUN	Terminal Y OFF delay time	V/F SVC FVC PMVF PMSVC PMFVC Set the delay time for terminal Y to switch from ON to OFF.	0.010s (0.000s~60.000s)
F06.30 (0x061E) RUN	Relay 1 terminal OFF delay time	V/F SVC FVC PMVF PMSVC PMFVC Set the delay time for terminal Y to switch from ON to OFF.	0.010s (0.000s~60.000s)
F06.31 (0x061F) RUN	extension terminal Y OFF delay time	V/F SVC FVC PMVF PMSVC PMFVC Set the delay time for terminal Y to switch from ON to OFF.	0.010s (0.000s~60.000s)
F06.32 (0x0620) RUN	extension relay 2 terminal OFF delay time	V/F SVC FVC PMVF PMSVC PMFVC Set the delay time for terminal Y to switch from ON to OFF.	0.010s (0.000s~60.000s)

Group F06.4x: Frequency Detection

Outputs frequency consistency and frequency reached signals to a multi-functional output terminal.

There are two groups of frequency detection judgment parameters in the drive.

The output frequency detection is shown as follows:

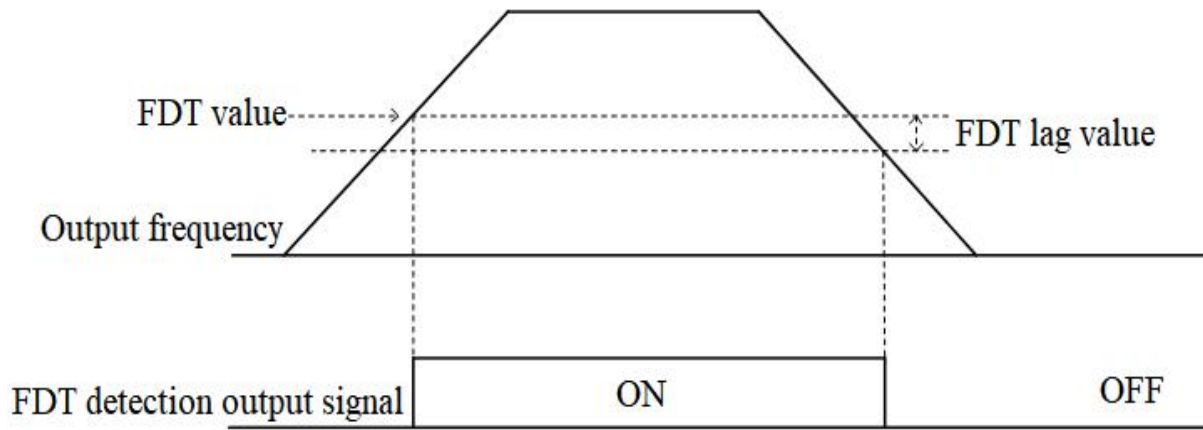

Schematic of Frequency Detection

◇ **F06.40: Frequency Detection Value 1**

Parameter Code (Address)	Name	Description	Default (Range)
F06.40 (0x0628) RUN	Frequency detection value 1	V/F SVC FVC PMVF PMSVC PMFVC Set frequency detection value 1.	2.00Hz (0.00Hz~F01.10)

Note:

- The frequency detection value is compared with the running frequency.

◇ **F06.41: Frequency Detection Range 1**

Parameter Code (Address)	Name	Description	Default (Range)
F06.41 (0x0629) RUN	Frequency detection range 1	V/F SVC FVC PMVF PMSVC PMFVC Set frequency detection range 1.	1.00Hz (0.00Hz~F01.10)

◇ **F06.42: Frequency Detection Value 2**

Parameter Code (Address)	Name	Description	Default (Range)
F06.42 (0x062A) RUN	Frequency detection value 2	V/F SVC FVC PMVF PMSVC PMFVC Set frequency detection value 2.	2.00Hz (0.00Hz~F01.10)

Note:

- The frequency detection value is compared with the running frequency.

◇ **F06.43: Frequency Detection Range 2**

Parameter Code (Address)	Name	Description	Default (Range)
F06.43 (0x062B) RUN	Frequency detection range 2	V/F SVC FVC PMVF PMSVC PMFVC Set frequency detection range 2.	1.00Hz (0.00Hz~F01.10)

◇ **F06.44: Detection Range for the Set Frequency Reached**

Parameter Code (Address)	Name	Description	Default (Range)
F06.44 (0x062C) RUN	Detection range for the given frequency reached	V/F SVC FVC PMVF PMSVC PMFVC Set the detection range for the set frequency reached.	2.00Hz (0.00Hz~F01.10)

The output for the set frequency reached is shown as follows:

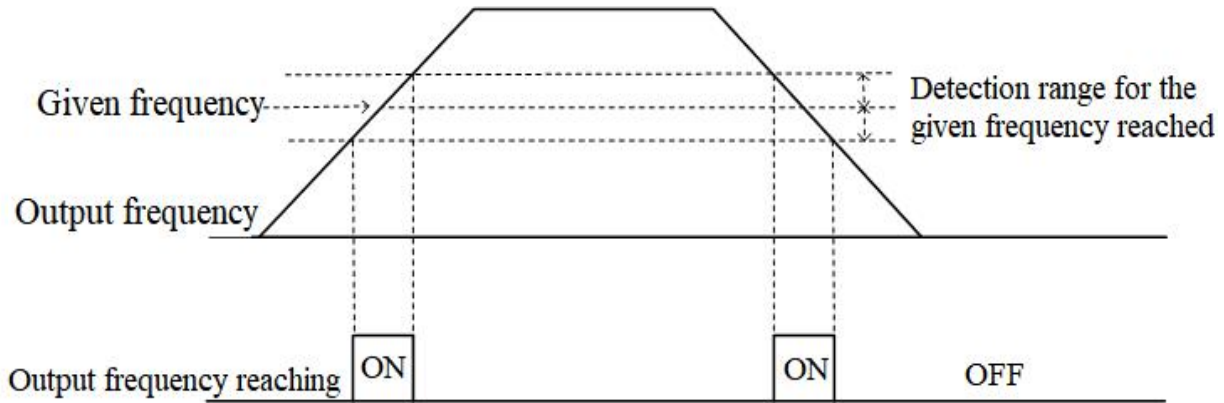

Schematic of Frequency Reaching Detection

Note:

- The frequency detection value is compared with the target frequency.

Group F06.5x: Monitoring Parameter Comparator Output

This group of parameters sets any monitoring parameter for comparator judgment, and selects multi-functional output terminal, warning or alert according to the judgment result, to meet the needs for the comparing the output of various monitoring variables.

F06.50 - F06.54: Comparator 1 (CP1)

Parameter Code (Address)	Name	Description	Default (Range)
F06.50 (0x0632) RUN	Comparator 1 monitor selection	V/F SVC FVC PMVF PMSVC PMFVC Select the parameter for comparator 1 to monitor. Ones and LED"00"s: Set yy in monitoring parameter number Cxx.yy Hundreds and LED"0000"s: Set xx in monitoring parameter number Cxx.yy	0001 (0000~0763)
F06.51 (0x0633) RUN	Comparator 1 upper limit	V/F SVC FVC PMVF PMSVC PMFVC Set the upper limit of comparator 1. The unit and the decimal place are determined by F06.50.	(Determined by F06.50)
F06.52 (0x0634) RUN	Comparator 1 lower limit	V/F SVC FVC PMVF PMSVC PMFVC Set the lower limit of comparator 1. The unit and the decimal place are determined by F06.50.	(Determined by F06.50)
F06.53 (0x0635) RUN	Comparator 1 bias	V/F SVC FVC PMVF PMSVC PMFVC Set the bias of comparator 1. The unit and the decimal place are determined by F06.50.	(Determined by F06.50)
F06.54 (0x0636) RUN	Comparator 1 action selection	V/F SVC FVC PMVF PMSVC PMFVC Select the action of comparator 1. 0: Continue running (digital terminal output only) 1: Alarm and free stop, E. CP1 2: Send a warning and keep running, A. CP1	0 (0~3)

		3: Forced stop	
--	--	----------------	--

Note:

- Comparator 1 action selection = 3:forced stop, the drive internal gives the stop command, and shuts down by the set stop mode.

◇ **F06.55 - F06.59: Comparator 2 (CP2)**

Parameter Code (Address)	Name	Description	Default (Range)
F06.55 (0x0637) RUN	Comparator 2 monitor selection	V/F SVC FVC PMVF PMSVC PMFVC Select the parameter for comparator 2 to monitor. Ones and LED"00"s: Set yy in monitoring parameter number Cxx.yy Hundreds and LED"0000"s: Set xx in monitoring parameter number Cxx.yy	0002 (0000~0763)
F06.56 (0x0638) RUN	Comparator 2 upper limit	V/F SVC FVC PMVF PMSVC PMFVC Set the upper limit of comparator 2. The units and the decimal place are determined by F06.55.	(Determined by F06.55)
F06.57 (0x0639) RUN	Comparator 2 lower limit	V/F SVC FVC PMVF PMSVC PMFVC Set the lower limit of comparator 2. The units and the decimal place are determined by F06.55.	(Determined by F06.55)
F06.58 (0x063A) RUN	Comparator 2 bias	V/F SVC FVC PMVF PMSVC PMFVC Set the bias of comparator 2. The units and the decimal place are determined by F06.55.	(Determined by F06.55)
F06.59 (0x063B) RUN	Comparator 2 action selection	V/F SVC FVC PMVF PMSVC PMFVC Set the action of comparator 2. 0: Continue running (digital terminal output only) 1: Alarm and free stop, E. CP2 2: Send a warning and keep running, A. CP2 3: Forced stop	0 (0~3)

Note:

- Comparator 2 action selection = 3: forced stop, the drive internal gives the stop command, and shuts down by the set stop mode.

Group F06.6x: Virtual Input and Output Terminals

The virtual input and output function can achieve the following functions:

- Without external wiring connection, inputting the output result of the multi-functional output terminal to the multi-functional input terminal;
- Without external wiring connection, inputting the output of the multi-functional analog output terminal to the multi-functional analog input terminal.

Warning: Safety precautions for restarting the machine: Before the drive trial operation, be sure to verify the setting points of parameters for the virtual input/output function. Without verification, unexpected actions of the drive may cause personal accidents.

The virtual input/output function is based on the virtual wiring of the input/output terminals inside the drive. Therefore, even if there is no physical wiring on the input/output terminals, the operation of the drive may be different from the factory settings.

Note:

For more details about the virtual digital input set points, refer to F05.00 - F05.09 "set point of multi-functional contact input".

For more details about the virtual digital output set points, refer to F06.21 - F06.24 "set point of multi-functional output".

The output delay setting of virtual terminals vY1 - vY4 is the same as that of relay Refer to **[F06.25 - F06.32] for detailed description.**

The virtual terminals are characterized by the combination of vXi and vYi. To use the output signal of terminal Y as the input signal of terminal X, connect the internal vXi to vYi virtually, so as save the actual terminals X and Y for other use.

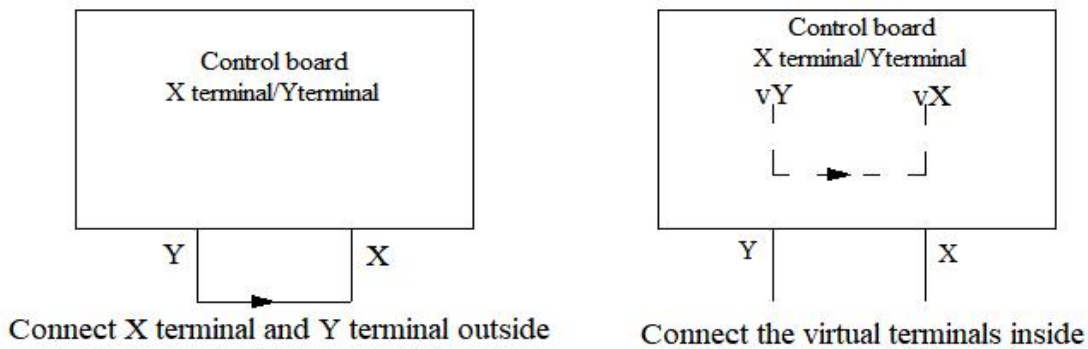

The following examples illustrate the applications of virtual vX and vY:

Example 1: In some situations, the drive is required to run as soon as the initialization is completed after power-on, and generally a terminal X is used as the input. However, if you use the virtual terminal, you can save the actual terminal X for other input use. The specific operation method is as follows:

- Set F01.01 = 1, terminal control as the run command source;
- Set F05.20 = 0, 2-wire control 1;
- Set F06.60 = 1, terminal input forward running;
- Set F06.64 = 0000, the activation state of vX1 is determined by vY1;
- Set F06.66 =8, drive output after it is ready to run.

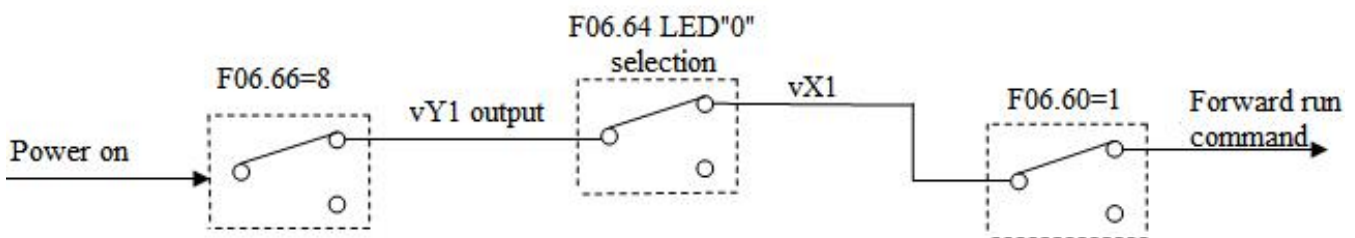

Schematic of Power-on Automatic Running Controlled by Virtual Terminal

◇ **F06.60 - F06.63: Virtual Digital Quantity Input Setting**

Parameter Code (Address)	Name	Description	Default (Range)
--------------------------	------	-------------	-----------------

F06.60 (0x063C) STOP	Function selection of virtual terminal vX1	V/F SVC FVC PMVF PMSVC PMFVC Refer to "Set Point of Multi-Functional Input" in F05.0x.	0 (0~95)
F06.61 (0x063D) STOP	Function selection of virtual terminal vX2	V/F SVC FVC PMVF PMSVC PMFVC Refer to "Set Point of Multi-Functional Input" in F05.0x.	0 (0~95)
F06.62 (0x063E) STOP	Function selection of virtual terminal vX3	V/F SVC FVC PMVF PMSVC PMFVC Refer to "Set Point of Multi-Functional Input" in F05.0x.	0 (0~95)
F06.63 (0x063F) STOP	Function selection of virtual terminal vX4	V/F SVC FVC PMVF PMSVC PMFVC Refer to "Set Point of Multi-Functional Input" in F05.0x.	0 (0~95)

Note:

- For more details about the virtual digital input set point, refer to "Set Point of Multi-Functional Input" in F05.0x.

◇ **F06.64: Activation State Source of Terminal vX**

Parameter Code (Address)	Name	Description	Default (Range)
F06.64 (0x0640) RUN	Activation state source of terminal vX	V/F SVC FVC PMVF PMSVC PMFVC Set the activation state source of terminal vX.	0000 (0000~2222)

The input states of virtual terminals vX1 - vX4 can be set in three ways, which are selected through **[F06.64]**:

When the states of vX1 - vX4 are selected to be connected to virtual terminals vY1 - vY4 internally, whether vX1 - vX4 are Valid depends on whether vY1 - vY4 outputs are Valid. vX1 - vY1, vX2 - vY2, vX3 - vY3, vX4 - vY4 are bounded one to one.

When the states of vX1 - vX4 are selected to be connected to physical terminals X1 - X4, whether vX1 - vX4 are Valid depends on whether X1 - X4 outputs are Valid.

When the states of vX1 - vX4 are selected to be set by function code, to activate terminals vX1 - vX4, set the state of the corresponding input terminals through the function code **[F06.65]** respectively.

LED"0": virtual vX1

- 0: Internally connected to virtual vY1
- 1: Connected to physical terminal X1
- 2: Whether the function code setting is Valid

LED"00": Virtual vX2

- 0: Internally connected to virtual vY2
- 1: Connected to physical terminal X2
- 2: Whether the function code setting is Valid

LED"000": Virtual vX3

- 0: Internally connected to virtual vY3
- 1: Connected to physical terminal X3
- 2: Whether the function code setting is Valid

LED"0000": Virtual vX4

- 0: Internally connected to virtual vY4
- 1: Connected to physical terminal X4
- 2: Whether the function code setting is Valid

◇ **F06.65: Activation State of Function Code Setting for Virtual Terminal vX**

Parameter Code (Address)	Name	Description	Default (Range)
F06.65 (0x0641) RUN	Activation state of function code setting for virtual terminal vX	V/F SVC FVC PMVF PMSVC PMFVC Set whether the function code setting for virtual terminal vX is Valid.	0000 (0000~1111)

LED"0": Virtual vX1

0: Invalid

1: Valid

LED"00": Virtual vX2

0: Invalid

1: Valid

LED"000": Virtual vX3

0: Invalid

1: Valid

LED"0000": Virtual vX4

0: Invalid

1: Valid

◇ **F06.66 - F06.69: Virtual Digital Quantity Output Setting**

Parameter Code (Address)	Name	Description	Default (Range)
F06.66 (0x0642) RUN	Virtual vY1 output selection	V/F SVC FVC PMVF PMSVC PMFVC Refer to "Set Point of Multi-Functional Output" in F06.2x.	0 (0~63)
F06.67 (0x0643) RUN	Virtual vY2 output selection	V/F SVC FVC PMVF PMSVC PMFVC Refer to "Set Point of Multi-Functional Output" in F06.2x.	0 (0~63)
F06.68 (0x0644) RUN	Virtual vY3 output selection	V/F SVC FVC PMVF PMSVC PMFVC Refer to "Set Point of Multi-Functional Output" in F06.2x.	0 (0~63)
F06.69 (0x0645) RUN	Virtual vY4 output selection	V/F SVC FVC PMVF PMSVC PMFVC Refer to "Set Point of Multi-Functional Output" in F06.2x.	0 (0~63)

Note:

- For more details about the set point of virtual digital quantity output, refer to "Set Point of Multi-Functional Output" in F06.2x.

✧ F06.66 - F06.69: Virtual Digital Quantity Output Setting

Parameter Code (Address)	Name	Description	Default (Range)
F06.70 (0x0646) RUN	vY1 output ON delay time	V/F SVC FVC PMVF PMSVC PMFVC Set the delay time taken by terminal vY1 from OFF to ON.	0.010s (0.000s~60.000s)
F06.71 (0x0647) RUN	vY2 output ON delay time	V/F SVC FVC PMVF PMSVC PMFVC Set the delay time taken by terminal vY2 from OFF to ON.	0.010s (0.000s~60.000s)
F06.72 (0x0648) RUN	vY3 output ON delay time	V/F SVC FVC PMVF PMSVC PMFVC Set the delay time taken by terminal vY3 from OFF to ON.	0.010s (0.000s~60.000s)
F06.73 (0x0649) RUN	vY4 output ON delay time	V/F SVC FVC PMVF PMSVC PMFVC Set the delay time taken by terminal vY4 from OFF to ON.	0.010s (0.000s~60.000s)
F06.74 (0x064A) RUN	vY1 output OFF delay time	V/F SVC FVC PMVF PMSVC PMFVC Set the delay time taken by terminal vY1 from ON to OFF.	0.010s (0.000s~60.000s)
F06.75 (0x064B) RUN	vY2 output OFF delay time	V/F SVC FVC PMVF PMSVC PMFVC Set the delay time taken by terminal vY2 from ON to OFF.	0.010s (0.000s~60.000s)
F06.76 (0x064C) RUN	vY3 output OFF delay time	V/F SVC FVC PMVF PMSVC PMFVC Set the delay time taken by terminal vY3 from ON to OFF.	0.010s (0.000s~60.000s)
F06.77 (0x064D) RUN	vY4 output OFF delay time	V/F SVC FVC PMVF PMSVC PMFVC Set the delay time taken by terminal vY4 from ON to OFF.	0.010s (0.000s~60.000s)

Note:

- For more details about the delay of virtual digital quantity output, refer to "Set Point of Multi-Functional Output" in F06.2x.

11.9 Group F07: Running Control

Group F07.0x: Start Control

The drive can be started up by three modes: Start frequency mode, DC brake mode and speed tracking mode.

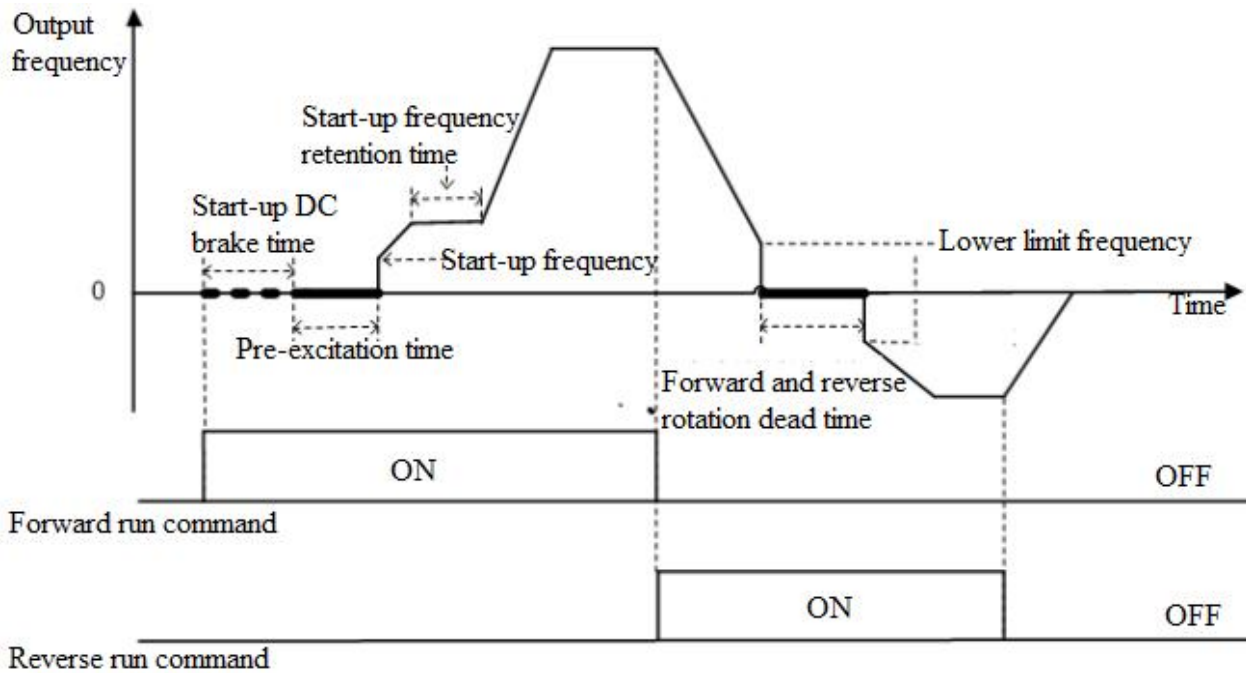

Schematic of Forward Start and Switching between Forward and Reverse Running

◇ F07.00: Start Modes

Parameter Code (Address)	Name	Description	Default (Range)
F07.00 (0x0700) STOP	Start mode	V/F SVC FVC PMVF PMSVC PMFVC Set the Start mode of the drive.	0 (0~2)

0: Start by Start frequency

In this mode, the output frequency starts from F07.02 [Start Frequency] and changes with the set acceleration time.

1: Apply DC brake first and then start up as per the Start frequency

In this mode, the drive will apply DC brake as per F07.20 [Start DC Brake Current] and F07.21 [DC Brake Time on Startup], and then start up as per the Start frequency. This mode applies to the scene that requires the motor speed is zero or low on startup. The drive will apply a brake force to the motor, and then start up.

2: Start up after speed tracking and direction judgment

First detect the speed and direction of the motor, and then start up the drive as per the detected speed. This mode applies to the scene that requires to start up the drive after stop due to large inertia load.

Note:

- When the set frequency on startup is lower than F07.02 [Start Frequency], the drive will stand by, with the running indicator on.

◇ F07.01: Start Pre-Excitation Time

Parameter Code (Address)	Name	Description	Default (Range)
F07.01 (0x0701) STOP	Start pre-excitation time	V/F SVC FVC PMVF PMSVC PMFV Establish a magnetic field before the motor starts, and set the pre-excitation time through this parameter.	0.00s (0.00s~60.00s)

Under the vector control of asynchronous motor, pre-excitation before startup can effectively improve the Start performance of the motor and reduce the Start current and time.

Note:

- This parameter is 0.00 s by default. The actual Start pre-excitation time is calculated automatically based on the motor parameters.
- When setting this parameter to a non 0.00 s, the Start pre-excitation time is the set point.

◇ F07.02: Start Frequency

Parameter Code (Address)	Name	Description	Default (Range)
F07.02 (0x0702) STOP	Start frequency	V/F SVC FVC PMVF PMSVC PMFVC On startup, the drive will use this set point as the initial output frequency.	0.50Hz (0.00Hz~F01.12)

To ensure the motor output torque on startup, please set a proper output frequency. Over-current suppression or over-current fault will occur if this parameter is set too high.

Note:

- When the setting frequency is lower than the Start frequency, the drive will stand by, with the running indicator light on.
- When the control mode is changed, the Default of F07.02 [Start Frequency] will be changed as follows.

Parameter	Control Mode	Defaults of F07.02 Start Frequency under Different Control Modes
F01.00	0: Asynchronous motor V/F control (V/F)	0.50Hz
	1: Asynchronous motor sensorless vector control (SVC)	0.50Hz
	2: Asynchronous motor flux vector control (FVC)	0.00Hz
	10: Synchronous motor V/F control (PMV/F)	0.50Hz
	11: Synchronous motor sensorless vector control (PMSVC)	0.50Hz
	12: Synchronous motor flux vector control (PMFVC)	0.00Hz

◇ F07.03: Start Protection Selection

Parameter Code (Address)	Name	Description	Default (Range)
F07.03 (0x0703) STOP	Start protection selection	V/F SVC FVC PMVF PMSVC PMFVC Select whether the set run command is Valid on startup.	0111 (0000~1111)

For convenience, the drive states are divided into three: fault state, undervoltage state and standby state. The fault state and the undervoltage state are called abnormal states.

LED"0": Terminal Start protection in case of abnormal exit

0: OFF

1: ON

This function can be Valid only when the control mode is set as terminal control.

LED"00": Jogging terminal Start protection in case of abnormal exit

0: OFF

1: ON

LED"000": Start protection when the command channel is changed to terminal

0: OFF

1: ON

LED"0000": Reserved

Note:

- The Start protection is enabled by default when the free stop, emergency stop or forced stop command is Valid.
- After the terminal Start protection is Valid, the terminal run command should be eliminated first, and then the Start protection can be Valid after setting again.
- After the Start protection is Valid, if a run command is inputted, the drive will not run and display the warning A.run3.

✧ **F07.05: Rotation Direction Selection**

Parameter Code (Address)	Name	Description	Default (Range)
F07.05 (0x0705) STOP	Rotation direction selection	V/F SVC FVC PMVF PMSVC PMFVC Select the direction of motor rotation.	0000 (0000~1121)

LED"0": Reverse running direction

0: Direction unchanged

If the actual direction of the motor is the same as the required direction, the motor will not change its direction;

1: Reverse direction

If the actual direction is contrary to the required direction, the motor direction will change it direction;

LED"00": Running direction disabled

Selects the activation state of the motor direction control.

0: Both forward and reserve commands are allowed

The drive accepts both forward and reserve commands to control motor running;

1: Only forward command is allowed

The drive only accepts forward commands to control motor running, and will not accept a reverse command.

2: Only reverse command is allowed

The drive only accepts reverse commands to control motor operation, and will not accept a forward command.

LED"000": Frequency-based direction control selection

Selects whether the negative frequency is allowed to change the drive running direction when the frequency setting point is negative.

0: Frequency-based direction control is Invalid

when the calculation result is negative, the drive will output frequency of 0.00 Hz;

1: Frequency-based direction control is Valid

when the calculation result is negative, the drive will change the current running direction and output corresponding frequency.

Note:

- If the drive is initialized through F00.03 [Initialization], the set point of this parameter will remain the same.

- If the parameters are downloaded through F00.04 [Download Parameters to the Drive], the set point of this parameter at LED"0" will remain the same.
- When you need to set multiple drives in a system with the same functional parameters by parameter copying, it is recommended not to calibrate the direction of the motor by reversing the running direction, but switch the three-phase output to two-phase output.

✧ F07.06 - F07.07: Restart Action upon Power Failure

Parameter Code (Address)	Name	Description	Default (Range)
F07.06 (0x0706) STOP	Selection of restart action upon power failure	V/F SVC FVC PMVF PMSVC PMFVC Select the function of restart action upon power failure.	0 (0~2)
F07.07 (0x0707) STOP	Waiting time for restart after power failure	V/F SVC FVC PMVF PMSVC PMFVC Set the standby time for restart action after power failure.	0.50s (0.00s~60.00s)

Selection of restart action upon power failure

0: Invalid After power failure, the drive will not run again until it receives a run command.

1: Speed tracking startup If the drive is running before the power failure, after the power is restored and after the time specified in F07.07 [Waiting Time for Restart after Power Failure], the drive will automatically start up by speed tracking.

2: Start according to the Start mode

Waiting time for restart after power failure

The waiting time for restart after power failure should be set based on the working recovery time of other equipment related to the drive after power supply is restored.

Note:

- During the waiting time for restart after power failure, the drive does not accept any run command, but if you input a stop command during this time, the drive will release the restart state.

Group F07.1x: Stop and Zero-Frequency Control

✧ F07.10: Stop Mode

Parameter Code (Address)	Name	Description	Default (Range)
F07.10 (0x070A) RUN	stop mode	V/F SVC FVC PMVF PMSVC PMFVC Select the stop mode of the drive when the run release command or the input stop command is Valid.	0 (0~1)

Note: stop commands include the run release command and input stop command.

0: Deceleration stop

When the stop command is inputted, the motor will decelerate until stop.

The motor will decelerate until stop according to the Valid deceleration time. The factory set deceleration time is F01.21 [Deceleration Time 1]. The actual deceleration time varies with load conditions such as mechanical loss and inertia.

During the deceleration time, when the output frequency reaches or is lower than the set point of F07.22 [DC Brake Start Frequency], the drive will enter the DC brake judgment during stop.

1: Free stop

When inputting the stop command, cut off the output of the drive. Then the motor will free stop.

The motor will free stop at the deceleration rate formed by the load conditions such as mechanical loss and inertia.

When the deceleration mode is set as free stop, all the stop commands will be processed as free stop.

Note:

- After stop, the drive will not respond to any run command during the time set by F07.12 [Minimum Time between stop and Restart].

✧ **F07.11: Stop Detection Frequency**

Parameter Code (Address)	Name	Description	Default (Range)
F07.11 (0x070B) RUN	stop detection frequency	V/F SVC FVC PMVF PMSVC PMFVC Set the frequency for judging whether the drive enters the deceleration stop from the running state when the stop command is inputted. If the output frequency is less than the set point, the drive will block output immediately and enter the stop state.	0.50Hz (0.00~F01.12)

When the drive receives the stop command under the deceleration stop mode, if the DC brake function is valid, and the output frequency is less than F07.22 [DC Brake Start Frequency], the drive will enter the stop DC brake state. If the output frequency is less than this set point, and the DC brake function is Invalid, the drive will block output immediately and enter the stop state.

Note:

- Under F07.10 = 1 [stop mode = free stop], neither stop detection frequency judgment nor DC brake action is carried out.

✧ **F07.12: Minimum Time between stop and Restart**

Parameter Code (Address)	Name	Description	Default (Range)
F07.12 (0x070C) STOP	Minimum time between stop and restart	V/F SVC FVC PMVF PMSVC PMFVC Set the minimum time between the drive switching from the running state to the stop state and accepting the run command.	0.000s (0.000s~60.000s)

The function is used when it is disallowed to frequently switch between startup and stop commands.

Note:

- During the minimum time between stop and restart, the drive will not respond to any run command.

✧ **F07.15: Selection of Action below Lower Frequency Limit**

Parameter Code (Address)	Name	Description	Default (Range)
F07.15 (0x070F) RUN	Selection of action below lower frequency limit	V/F SVC FVC PMVF PMSVC PMFVC Set the action when the output frequency is below the lower limit frequency during running.	2 (0~3)

0: Run according to the frequency command

The drive runs normally.

1: Enter the halt state and block the output.

When the set frequency and output frequency are less than or equal to the lower frequency limit, the drive will block the output and enter the halt state, and the motor will free stop.

After entering the halt state, when the set frequency is greater than the lower frequency limit, the drive will exit the halt state and enter the normal Start control.

2: Run at the lower frequency limit

When the set frequency and output frequency are less than or equal to the lower frequency limit, the drive will output as per the lower frequency limit.

3: Run at zero speed

When the set frequency and output frequency are less than or equal to the lower frequency limit, the drive will decelerate to zero

frequency and enter zero-speed control (under FVC) or zero-speed torque function control (under SVC or V/F control).

After entering the zero-speed control, when the set frequency is greater than lower limit frequency, the drive will exit the zero-speed control and enter the normal Start control.

Note:

- This function is active when there is a run command and the output frequency is less than the lower frequency limit, such as the forward/reverse over-zero state. It is inactive in the process of stop deceleration.
- When F07.10 = 1 [stop mode = free stop] and the stop command is Valid, the drive will not make this function judgment.

◇ **F07.16 - F07.17 Zero-Speed Torque Retention**

Parameter Code (Address)	Name	Description	Default (Range)
F07.16 (0x0710) RUN	Zero-speed torque retention current	V/F SVC FVC PMVF PMSVC PMFVC 100.0% corresponds to the motor rated current, and the upper limit of the zero-speed torque current is the rated current of the drive.	60.0% (0.0%~150.0%)
F07.17 (0x0711) RUN	Zero-Speed torque retention time	V/F SVC FVC PMVF PMSVC PMFVC Set the time of zero-speed torque retention function. The zero-speed torque is free of time limit when this parameter is set as 6000.0 s.	0.0s (0.0s~6000.0s)

Zero-speed torque retention current:

100.0% corresponds to the motor rated current, but the upper limit of the zero-speed torque current is the rated current of the drive.

When the output frequency decelerates to F07.02 [Start Frequency], the drive will enter zero-speed torque control state.

The value of zero-speed torque retention current will affect the magnetic field strength of the fixed motor shaft. Increasing the current value will increase the heat produced by the motor. Please set the minimum current value for the fixed motor shaft.

Zero-speed torque retention time:

Sets the time of zero-speed torque retention function. When the output frequency is less than F07.02 [Start Frequency], the drive will start to count up the time.

Conditions for activating the zero-speed torque function:

Condition	Name
Control Mode	Vector control or V/F control mode.
Running state	Normal running state, non-stop deceleration.
Output frequency threshold	Less than F07.02 [Start Frequency], entering zero-speed running state.

◇ **F07.18: Forward and Reverse Rotation Dead Time**

Parameter Code (Address)	Name	Description	Default (Range)
F07.18 (0x0712) STOP	Forward and reverse rotation dead time	V/F SVC FVC PMVF PMSVC PMFVC Set the zero-frequency retention time in the case of switching between forward and reverse rotations.	0.0s (0.0s~120.0s)

When the drive switches between forward and reverse commands, reaches the zero frequency and enters the forward and reverse rotation dead zone state, it will start to count up the time. After the drive exits the forward and reverse dead zone state, the timer will be reset.

To exit the forward and reverse rotation dead zone state:

Exit Mode	Post-Exit Control Mode
Forward and reverse rotation dead time up	Enter normal Start control.
Reverse command	Enter normal Start control.
stop command	Enter stop control.

In forward and reverse rotation dead zone state:

Control Mode	Achieving Mode
SVC, V/F	When the zero-speed torque is active, the drive will enter the zero-speed torque control state.
SVC, V/F	When the zero-speed torque is inactive, the output frequency and voltage will be zero.
FVC	Enter the zero-speed control.

Note:

- This function is used in the scene where needs to wait for a certain time at zero-speed for relevant process preparation.
- The forward and reverse rotation dead zone state does not conflict with the zero-speed torque retention function, and both of them count up the time from zero frequency.

Group F07.2x: DC Braking and Speed Tracking

✧ F07.20 - F07.21: Start DC Brake

Parameter Code (Address)	Name	Description	Default (Range)
F07.20 (0x0714) STOP	Start DC braking current	V/F SVC FVC PMVF PMSVC PMFVC 100.0% corresponds to the motor rated current, and the upper limit of braking current is the rated current of the drive.	60.0% (0.0%~150.0%)
F07.21 (0x0715) STOP	DC braking time on startup	V/F SVC FVC PMVF PMSVC PMFVC Sets the retention time of DC braking on startup.	0.0s (0.0s~60.0s)

Note: This function can be valid when F07.00 = 1 [Start mode = applying DC braking first and then start up as per the Start frequency].

After the run command is valid, if the pre-excitation function is invalid, the drive will enter the Start DC braking state; if the pre-excitation function is valid, the drive will enter the Start DC braking state after the completing the pre-excitation.

Start DC braking current

100.0% corresponds to the motor rated current, but the upper limit of Start DC braking current is the rated current of the drive.

The DC braking current will affect the magnetic field strength of the fixed motor shaft. Increasing the current value will increase the heat produced by the motor. Please set the minimum current value for the fixed motor shaft.

DC braking time on startup:

After the run command is valid, if the pre-excitation function is invalid, the drive will start to count up the time; if the pre-excitation function is valid, the drive will start to count up the time after the completing the pre-excitation.

Note:

- To start the motor which is running freely, use the Start DC braking to stop the motor before starting it, or use the speed tracking to start the motor.

✧ F07.22 - F07.24: Shut-down DC Brake

Parameter Code (Address)	Name	Description	Default (Range)
F07.22	DC braking start	V/F SVC FVC PMVF PMSVC PMFVC	1.00Hz

(0x0716) STOP	frequency	Set the threshold for the drive to enter the stop DC braking.	(0.00Hz~50.00Hz)
F07.23 (0x0717) STOP	Stop DC braking current	V/F SVC FVC PMVF PMSVC PMFVC 100.0% corresponds to the motor rated current, and the upper limit of braking current is the rated current of the drive.	60.0% (0.0%~150.0%)
F07.24 (0x0718) STOP	Stop DC braking time	V/F SVC FVC PMVF PMSVC PMFVC Set the retention time of DC braking during stop.	0.0s (0.0s~60.0s)

Note: Stop DC braking can be valid when F07.10 = 0[stop mode = deceleration stop].

Under the stop command, when the output frequency is less than F07.22 [DC Braking Start Frequency], the drive will enter the stop DC braking state.

The drive will enter the stop state after completing the stop DC braking.

If the drive receives the run command in the process of stop DC braking, it will exit the stop DC braking state and enter the normal Start control.

Stop DC brake current

100.0% corresponds to the motor rated current, but the upper limit of stop DC braking current is the rated current of the drive.

The DC braking current will affect the magnetic field strength of the fixed motor shaft. Increasing the current value will increase the heat produced by the motor. Please set the minimum current value for the fixed motor shaft.

DC braking time during stop:

The drive will start to count up the time after entering the stop DC braking state; it will reset the time after exiting the stop DC braking state, and restart to count up the time at next time.

✧ F07.25~F07.28: Speed Tracking

Parameter Code (Address)	Name	Description	Default (Range)
F07.25 (0x0719) STOP	Speed tracking mode	V/F SVC FVC PMVF PMSVC PMFVC Set the speed tracking mode.	0000 (0000~1111)
F07.26 (0x071A)STOP	Speed tracking time	V/F SVC FVC PMVF PMSVC PMFVC Set the speed tracking time.	0.5s (0.0s~60.0s)
F07.27 (0x071B) STOP	Speed tracking stop delay	V/F SVC FVC PMVF PMSVC PMFVC Set the speed tracking stop delay.	1.00s (0.00s~60.00s)
F07.28 (0x071C) STOP	Speed tracking current	V/F SVC FVC PMVF PMSVC PMFVC Set the upper limit of speed tracking current.	120.0% (0.0%~400.0%)

Speed tracking mode:**LED"0": Search mode**

0: Search from maximum frequency

1: Search from stop frequency

LED"00": Reverse search selection

0: OFF

1: ON

LED"000": Search source

0: Software search

1: Hardware search

LED"0000": Reserved**Note:**

- This function valid when F07.00 = 2 [Start mode = speed tracking startup].
- After the reverse search is enabled, the motor may search for the reverse. Do not enable this function when reverse running is disallowed.

Speed tracking time:

During the drive speed tracking startup, the shorter time the drive takes to increase the output voltage to the normal voltage at the current speed, the faster the tracking process will be, but the higher impact current the tracking process produces. When the time is zero, the tracking speed is automatically controlled by the internal of the drive.

Speed tracking stop delay:

After the output is cut off, the drive will output voltage again to start the motor after a period of delay time, so as to minimize the impact current on startup. When the time is zero, the delay is automatically controlled by the internal of the drive.

Group F07.3x: Jogging

◇ F07.30: Jogging Frequency

Parameter Code (Address)	Name	Description	Default (Range)
F07.30 (0x071E) RUN	Jogging frequency	V/F SVC FVC PMVF PMSVC PMFVC Set the frequency for jogging.	5.00Hz (0.00Hz~F01.10)

Note:

- Jogging command has a higher priority. If the jogging command is valid during running, the drive will enter the jogging control directly.
- The set upper limit is subject to F01.10 [Maximum Frequency].

◇ F07.31 - F07.32 Jogging Acceleration/Deceleration Time

Parameter Code (Address)	Name	Description	Default (Range)
F07.31 (0x071F) RUN	Jogging acceleration time	V/F SVC FVC PMVF PMSVC PMFVC Set the time for the jogging output frequency to accelerate from 0 to the frequency selected by F01.20.	10.00s (0.01s~650.00s)
F07.32 (0x0720) RUN	Jogging deceleration time	V/F SVC FVC PMVF PMSVC PMFVC Set the time for the jogging output frequency to decelerate from the frequency selected by F01.20 to 0.	10.00s (0.01s~650.00s)

Note:

- F01.20 = 0, 1, 2 [Reference frequency for acceleration/deceleration time = maximum frequency, fixed frequency 50.00 Hz, set frequency].

◇ F07.33: Jogging S-curve Selection

Parameter Code (Address)	Name	Description	Default (Range)
F07.33 (0x0721) RUN	Jogging S-curve selection	V/F SVC FVC PMVF PMSVC PMFVC Sets whether the S-curve is Valid during jogging.	1 (0~1)

0: Invalid

1: Valid

Note:

- The time of jogging S-curve is the same as that of non-jogging S-curve. Both of them are F01.31 - F01.34.

◇ F07.34: Jogging Stop Mode

Parameter Code (Address)	Name	Description	Default (Range)
F07.34 (0x0722) RUN	Jogging stop mode	V/F SVC FVC PMVF PMSVC PMFVC Sets the jogging stop mode.	0 (0~1)

0: The same as the stop mode set by F07.10.

F07.10 = 0 [stop mode = deceleration stop];

F07.10 = 1 [stop mode = free stop].

1: Deceleration stop only

The stop mode is not affected by setting of F07.10, and is only deceleration stop.

Note:

- In the jogging deceleration stop only mode, the drive neither enters the stop DC brake, nor enters the judgment of retention frequency during stop.
- The function of Start retention frequency is Invalid during jogging.
- The jogging frequency setting is not subject to the lower frequency limit.

Group F07.4x: Start and Stop Frequency Retention and Frequency Hopping

◇ F07.40~F07.43: Start and stop Frequency Retention

This function is used to retain the set output frequency temporarily on startup or stop.

This function can prevent the motor from stalling when starting or stopping under heavy load. Furthermore, this function also can avoid the shock caused by mechanical backlash at the beginning of acceleration and deceleration.

During acceleration, the drive will automatically run at a low speed by the set output frequency and time to reduce the impact of backlash and then accelerate again. The same effect is achieved during deceleration.

For handling machinery, this function can be used to wait for the opening and closing delay of the electromagnetic brake on the mechanical or motor side according to the output frequency of the drive.

Parameter Code (Address)	Name	Description	Default (Range)
F07.40 (0x0728) STOP	Start retention frequency	V/F SVC FVC PMVF PMSVC PMFVC Set the temporarily retained output frequency when the motor starts.	0.50Hz (0.00Hz~F01.12)
F07.41 (0x0729) STOP	Start frequency retention time	V/F SVC FVC PMVF PMSVC PMFVC Set the retention time of the temporary output frequency when the motor starts.	0.00s (0.00s~60.00s)

When the output frequency reaches the frequency set by F07.40 during the Start acceleration, the drive will retain this frequency for the time set in F07.41, and then continue to accelerate.

Note:

- The function of Start retention frequency is Invalid during jogging.

Parameter Code (Address)	Name	Description	Default (Range)
F07.42 (0x072A) STOP	Stop retention frequency	V/F SVC FVC PMVF PMSVC PMFVC Set the temporarily retained output frequency when the motor starts.	0.50Hz (0.00Hz~F01.12)
F07.43 (0x072B) STOP	Stop frequency retention time	V/F SVC FVC PMVF PMSVC PMFVC Set the retention time of the temporary output frequency when the motor starts.	0.00s (0.00s~60.00s)

When the output frequency reaches the frequency set by F07.42 during the stop deceleration, the drive will retain this frequency for the time set in F07.43, and then continue to decelerate.

Note:

- In the jogging deceleration stop only mode, the drive neither enters the stop DC brake, nor enters the judgment of retention frequency during stop.

◇ F07.44~F07.47: Hopping Frequency

This function is used to set a dead zone for a specific frequency band. When a machine previously running at a constant speed is running at a variable speed, resonance may occur. To avoid the resonance caused by the natural vibration frequency of the mechanical system during running, it is necessary to hop specific frequency bands.

Hopping frequency can be set at 2 places at most. Set the central value of the frequency to hop through F07.44 and F07.46 [Hopping Frequency 1, 2], and set frequency amplitude through F07.45 and F07.47 [Hopping Frequency Amplitude 1, 2].

When the input frequency command is the same as or similar to the hopping frequency band, the drive will change the frequency command automatically.

Make the motor accelerate or decelerate smoothly until the frequency command is beyond the range of the hopping frequency band. The acceleration/deceleration rate at this time is determined by the Valid set acceleration/deceleration time. When the frequency command is beyond of the range of the hopping frequency band, the drive will change to run at a constant speed.

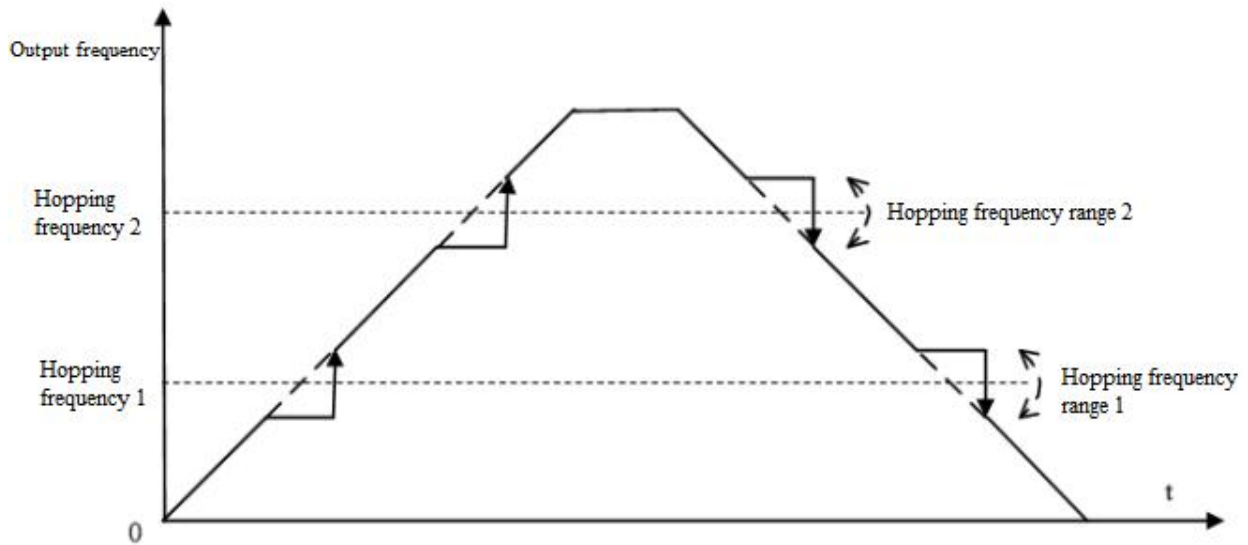

Schematic of Hopping Frequency Action

Parameter Code (Address)	Name	Description	Default (Range)
F07.44 (0x072C) RUN	Hopping frequency 1	V/F SVC FVC PMVF PMSVC PMFVC Set the central value of the specific frequency band to be hopped.	0.00Hz (0.00Hz~F01.10)
F07.45 (0x072D) RUN	Hopping frequency amplitude 1	V/F SVC FVC PMVF PMSVC PMFVC Set the amplitude of the specific frequency band to be hopped.	0.00Hz (0.00Hz~F01.10)

Note: When F07.44 [Hopping Frequency 1] is set to 0.00 Hz, hopping frequency 1 is Invalid.

Parameter Code (Address)	Name	Description	Default (Range)
F07.46 (0x072E) RUN	Hopping frequency 2	V/F SVC FVC PMVF PMSVC PMFVC Set the central value of the specific frequency band to be hopped.	0.00Hz (0.00Hz~F01.10)
F07.47 (0x072F) RUN	Hopping frequency amplitude 2	V/F SVC FVC PMVF PMSVC PMFVC Set the amplitude of the specific frequency band to be hopped.	0.00Hz (0.00Hz~F01.10)

Note:

➤ When F07.46 [Hopping Frequency 2] is set to 0.00 Hz, hopping frequency 2 is Invalid.

11.10 Group F08: Auxiliary Control 1

Group F08.0x: Counting and Timing

Counting

The relevant setting parameters for this function are shown as follows:

Parameter	Name	Default	Function
F05.0x	Multi-functional input terminal.	42	Counter signal input.

F05.0x	Multi-functional input terminal.	43	Count value reset.
F06.21~F06.24	Multi-functional output terminal.	22	Count value reaches maximum.
F06.21~F06.24	Multi-functional output terminal.	23	Count value reaches set point.
C00.22	Count value.		

◇ F08.00: Counter Input Source

Parameter Code (Address)	Name	Description	Default (Range)
F08.00 (0x0800) RUN	Counter input source	V/F SVC FVC PMVF PMSVC PMFVC Set the input source for the internal timer of the drive.	0 (0~2)

0: Common multi-functional input terminals The frequency of input signal is less than 100 Hz.

1: Output terminal PUL The upper frequency limit of input signal is determined by the selection in F05.30.

2: Speed feedback card (PG card)

Note:

- When choosing different input sources, pay attention to the upper frequency limit of the signal.
- When F08.00 = 0, the input signal should be connected with the setting terminal of F05.0x = 42 [Multi-functional input terminal = counter input terminal].

◇ F08.01: Count Frequency Division

Parameter Code (Address)	Name	Description	Default (Range)
F08.01 (0x0801) RUN	Count frequency division	V/F SVC FVC PMVF PMSVC PMFVC Set the count frequency division value.	0 (0~6000)

The monitoring parameter C00.22 [Count value] is obtained by frequency division of the count signal.

Note:

- The values compared with F08.02 [Timer Maximum Value] and F08.03 [Timer Set Point] are both count values in C00.22.

◇ F08.02: Counter Maximum Value

Parameter Code (Address)	Name	Description	Default (Range)
F08.02 (0x0802) RUN	Counter maximum value	V/F SVC FVC PMVF PMSVC PMFVC Set the counter maximum value.	1000 (0~65000)

F06.21 - F06.24 = 22 [Multi-functional output terminal = Count value reaches maximum]. When the count value reaches the value set by F08.02, the corresponding output terminal will output an activation signal and reset the value of C00.22 to zero. The output signal width is equal to the clock period of the active signal of the external input terminal, that is, the output terminal will stop outputting the activation signal when the next count signal is inputted.

◇ F08.03: Counter Set Point

Parameter Code (Address)	Name	Description	Default (Range)
F08.03 (0x0803) RUN	Counter set point	V/F SVC FVC PMVF PMSVC PMFVC Set the counter set point.	500 (0~65000)

F06.21 - F06.24 = 23 [Multi-functional output terminal = Count value reaches the set point]. When the count value reaches the value set by F08.03, the corresponding output terminal will output an activation signal with a width of the value that the output signal exceeds the value specified in parameter F08.02, which causes the output terminal will not stop outputting the activation signal until the counter is reset.

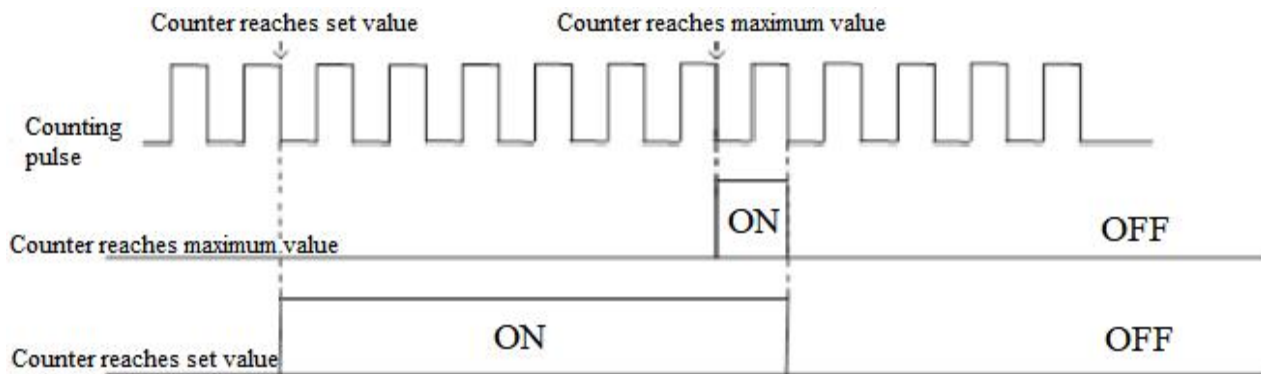

Schematic of Operations for Counter Maximum Value and Set Value

Note:

- The counter set point is required to be less than or equal to the timer maximum value.
- C00.22 count value can be reset by using the terminal set by F05.0x = 43 [Multi-functional input terminal = counter reset].

Fixed length control

$F08.06$ [Actual length] = $C00.22/F08.04$.

When $F08.06$ [Actual length] is longer than $F08.05$ [Set length], use output terminal to output an activation signal through F06.21 - F06.42 = 20 [Multi-functional output terminal = meter length reached], to perform stop control or next action start control.

◇ **F08.04: Number of Pulses per Meter**

Parameter Code (Address)	Name	Description	Default (Range)
F08.04 (0x0804) RUN	Number of pulses per meter	V/F SVC FVC PMVF PMSVC PMFVC Set the number of pulses per meter.	10.0 (0.1~6553.5)

◇ **F08.05: Set Length**

Parameter Code (Address)	Name	Description	Default (Range)
F08.05 (0x0805) STOP	Set length	V/F SVC FVC PMVF PMSVC PMFVC Set the set length.	1000m (0m~65535m)

Note:

➤ The range of set length should not exceed the calculated value of F08.02/F08.04.

◇ **F08.06: Actual Length**

Parameter Code (Address)	Name	Description	Default (Range)
F08.06 (0x0806) STOP	Actual length	V/F SVC FVC PMVF PMSVC PMFVC Set the actual length. This parameter is read only.	0m (0m~65535m)

Note: F08.06 [Actual Length] = C00.22/F08.04.

Timer

Timer starts to count up when the external trigger terminal receives the activation signal. After the set time is reached, the corresponding output terminal will output a pulse signal with a width of 1 s.

When the trigger terminal is Invalid, the timer will keep the current time value, and cumulate the time after the trigger terminal is Valid.

Timer reset terminal can reset the time at any time.

The relevant setting parameters for this function are shown as follows:

Parameter	Name	Default	Function
F05.0x	Multi-functional input terminal.	40	Timer triggered.
F05.0x	Multi-functional input terminal.	41	Timer reset.
F06.21~F06.24	Multi-functional output terminal.	21	Timer's set time reached.
C00.30	Timer's countup time.		

◇ **F08.07: Timer Time Unit**

Parameter Code (Address)	Name	Description	Default (Range)
F08.07 (0x0807) STOP	Timer time unit	V/F SVC FVC PMVF PMSVC PMFVC Sets the timer time unit. 0: Second 1: Minute 2: Hour	0 (0~2)

✧ **F08.08: Timer Set Point**

Parameter Code (Address)	Name	Description	Default (Range)
F08.08 (0x0808) STOP	Timer set point	V/F SVC FVC PMVF PMSVC PMFVC Set the timer set point.	0 (0~65000)

Group F08.3x: Swing Frequency Control

Under swing frequency control, the drive will make the output frequency change periodically as per the pre-set acceleration and deceleration time. This function is especially suitable for textile industry, or other systems that need to change the speed according to the different front and rear diameters of bobbin.

✧ **F08.30: Swing Frequency Control**

Parameter Code (Address)	Name	Description	Default (Range)
F08.30 (0x081E) STOP	Swing frequency control selection	V/F SVC FVC PMVF PMSVC PMFVC Select whether swing frequency control is valid. 0: OFF 1: ON	0 (0~1)

✧ **F08.31: Swing Frequency Amplitude Control Selection**

Parameter Code (Address)	Name	Description	Default (Range)
F08.31 (0x081F) STOP	Swing frequency amplitude control selection	V/F SVC FVC PMVF PMSVC PMFVC Select the control mode of swing frequency amplitude.	0000 (0000~0111)

LED"0": Start mode

0: Automatic

1: Manual setting by terminal

LED"00": Swing amplitude control

0: Relative to center frequency

1: Relative to maximum frequency

LED"000": Preset frequency enabling

0: Disabled

1: Enabled

LED"0000": Reserved

✧ F08.32: Preset Swing Frequency

Parameter Code (Address)	Name	Description	Default (Range)
F08.32 (0x0820)	Preset swing frequency	V/F SVC FVC PMVF PMSVC PMFVC Set the preset swing frequency.	0.00Hz (0.00Hz~F01.10)

✧ F08.33: Preset Swing Frequency Waiting Time

Parameter Code (Address)	Name	Description	Default (Range)
F08.33 (0x0821) STOP	Preset swing frequency waiting time	V/F SVC FVC PMVF PMSVC PMFVC Set the waiting time for the preset swing frequency.	0.0s (0.0s~3600.0s)

✧ F08.34: Swing Frequency Amplitude

Parameter Code (Address)	Name	Description	Default (Range)
F08.34 (0x0822) STOP	Swing frequency amplitude	V/F SVC FVC PMVF PMSVC PMFVC Set the swing frequency amplitude.	10.0% (0.0%~50.0%)

✧ F08.35: Jump Frequency

Parameter Code (Address)	Name	Description	Default (Range)
F08.35 (0x0823) STOP	Jump frequency	V/F SVC FVC PMVF PMSVC PMFVC Set the jump frequency.	10.0% (0.0%~50.0%)

✧ F08.36: Triangular Wave Rise Time

Parameter Code (Address)	Name	Description	Default (Range)
F08.36 (0x0824) STOP	Triangular wave rise time	V/F SVC FVC PMVF PMSVC PMFVC Set the rise time of triangular wave.	5.00s (0.0s~650.00s)

✧ F08.37: Triangular Wave Drop Time

Parameter Code (Address)	Name	Description	Default (Range)
F08.37 (0x0825) STOP	Triangular wave drop time	V/F SVC FVC PMVF PMSVC PMFVC Set the drop time of triangular wave.	5.00s (0.0s~650.00s)

11.11 Group F09: Auxiliary Control 2

Group F09.0x: Maintenance Functions

Parameter Code (Address)	Name	Description	Default (Range)
F09.02 (0x0902) RUN	Device maintenance alarm selection	V/F SVC FVC PMVF PMSVC PMFVC 0: Invalid 1: Valid LED"0": Cooling fan LED"00": Main rely LED"000": Reserved LED"0000": Reserved	0000 (0000~1111)
F09.03 (0x0903) STOP	Cooling fan maintenance setting	V/F SVC FVC PMVF PMSVC PMFVC Set in hours. Set to 0 when replacing the cooling fan with a new one.	0 (0~65535)
F09.04 (0x0904) STOP	Main relay maintenance setting	V/F SVC FVC PMVF PMSVC PMFVC Set to 0.0% when replaced the main relay with a new one.	0.0% (0.0%~150.0%)

Note:

- This group of function codes can set the replacement and maintenance of the main components of the drive.
- LED"0" of [F9.02] Device Maintenance Alarm Selection [Cooling fan] = 1 [Valid], when the cooling fan service life reaches 90%, A. 161 warning will be issued.
- LED"00" of [F9.02] Device Maintenance Alarm Selection [Main relay] = 1 [Valid], when the main relay service life reaches 90%, A. 163 warning will be issued.

11.12 Group F10: Protection Parameters

Group F10.0x: Current Protection

Parameter Code (Address)	Name	Description	Default (Range)
F10.00 (0x0A00) RUN	Over-current suppression function	V/F SVC FVC PMVF PMSVC PMFVC Automatically limits the output current to the set over-current suppression point to prevent over-current fault. 0: Suppression is always Valid. 1: Valid during acceleration/deceleration, invalid at constant speed.	0 (0~1)

0: Suppression is always Valid.

When the output current of drive reaches the over-current suppression point during acceleration, deceleration, or running at the constant speed, the drive will reduce the output current through software control (pause acceleration and deceleration, decrease or increase the output frequency, etc.). When the output current drops below the over-current suppression point, the drive will work normally.

1: Valid during acceleration/deceleration, Invalid at constant speed.

The over-current suppression function is active when the drive is accelerating and decelerating, but inactive when the drive is running at a constant speed.

Note: This function code selection can be valid only under VF control mode, and the over-current suppression function is always active under vector control.

Under the constant speed running mode, over-current fault may be reported when the load changes too much.

Parameter Code (Address)	Name	Description	Default (Range)
--------------------------	------	-------------	-----------------

F10.01 (0x0A01) RUN	Over-current suppression point	V/F SVC FVC PMVF PMSVC PMFVC Set the load current limiting level. 100% corresponds to the rated current of the drive.	160.0% (0.0%~300.0%)
---------------------------	--------------------------------	---	-------------------------

Sets the load current limiting level of the over-current suppression function. 100% corresponds to the rated current of the drive. When the output current ratio is greater than this value, the over-current suppression function will be triggered.

Parameter Code (Address)	Name	Description	Default (Range)
F10.02 (0x0A02) RUN	Over-current suppression gain	V/F SVC FVC PMVF PMSVC PMFVC Set the response effect of over-current suppression. The higher the set point, the faster the response.	100.0% (0.0%~500.0%)

Sets the response speed of over-current suppression function.

Parameter Code (Address)	Name	Description	Default (Range)
F10.03 (0x0A03) STOP	Current protection setting 1	V/F SVC FVC PMVF PMSVC PMFVC Set whether the current-related protection function is enabled. LED"0": Cycle-by-cycle current limiting (CBC) 0: OFF 1: ON LED"00": OC protection interference suppression 0: Normal 1: Primary interference suppression 2: Secondary interference suppression LED"000": SC protection interference suppression 0: Normal 1: Primary interference suppression 2: Secondary interference suppression LED"0000": Reserved	0001 (0000~f221)

Sets whether the current-related protection function is enabled.

LED"0": Cycle-by-cycle current limiting (CBC)

Cycle-by-cycle current limiting function through hardware protection, to a certain extent can limit the rise of current to avoid the drive from reporting overcurrent fault.

0: OFF

1: ON

LED"00": OC protection interference suppression

When this function is valid, the software judges the E. oC [Overcurrent fault], eliminates interference signals and only responds to real overcurrent signals. After the secondary interference suppression is enabled, all edge signal information will be filtered.

0: Normal

1: Primary interference suppression

2: Secondary interference suppression

Note: This function may delay the alarm time of overcurrent fault, please use it with caution.

LED"000": SC protection interference suppression

When the function is Valid, the software judges the E. SC [System fault], eliminates interference signals and only responds to real system fault signals. After the secondary interference suppression is enabled, all edge signal information will be filtered.

0: Normal

1: Primary interference suppression

2: Secondary interference suppression

Note: This function may delay the alarm time of system fault, please use it with caution.

LED"0000": Reserved

◇ **F10.04 - F10.06: Current Imbalance Protection**

Parameter Code (Address)	Name	Description	Default (Range)
F10.04 (0x0A04) STOP	Current protection setting 2	V/F SVC FVC PMVF PMSVC PMFVC LED"0": Judgment for non-zero sum of three-phase current detection, output fault warning E. HAL. 0: OFF 1: ON LED"00": 3-phase current imbalance protection judgment, output fault warning E. oLF4. 0: OFF 1: ON	0001 (0000~0011)
F10.05 (0x0A05) STOP	Current imbalance judgment threshold	V/F SVC FVC PMVF PMSVC PMFVC Determines the existence of a current imbalance fault by comparing the ratio of the maximum phase to the minimum phase in the three-phase current with this set point. When the threshold is exceeded, the fault is reported after F10.06 filter time.	160% (0%~500%)
F10.06 (0x0A06) STOP	Current imbalance filter coefficient	V/F SVC FVC PMVF PMSVC PMFVC The parameter value should be increased at a site with strong current fluctuation.	2.0 (0.0~60.0)

Group F10.1x: Voltage Protection

Parameter Code (Address)	Name	Description	Default (Range)
F10.11 (0x0A0B) STOP	DC bus overvoltage suppression function	V/F SVC FVC PMVF PMSVC PMFVC Slows down or stops acceleration or deceleration to prevent overvoltage fault when the DC bus voltage is higher than the overvoltage suppression point. LED"0": overvoltage suppression function 0: OFF 1: ON LED"00": Over-excitation function 0: OFF 1: Valid only during deceleration 2: Valid during running	0011 (0000~0021)

LED"0": overvoltage suppression function

0: OFF

If the DC bus voltage is greater than the overvoltage suppression point, the output frequency is not adjusted, which may trigger E.OU [overvoltage fault].

1: ON

The overvoltage suppression function is active in operation, especially for eccentric load.

Note: The overvoltage suppression function is active in any control mode. When the regenerative load increases suddenly, even if the overvoltage suppression function is switched on, it is possible to report E. OU [overvoltage failure].

LED"00": Over-excitation function

0: OFF

Do not increase the excitation current during deceleration, and the over-excitation function is Invalid.

1: Valid only during deceleration

over-excitation deceleration increases the excitation current during deceleration. Setting the motor in the overexcited state to make the motor decelerate sharply by producing greater brake torque. This process is faster than the common deceleration stop.

2: Valid during running

Precautions for the use of over-excitation deceleration:

Do not use over-excitation deceleration function for the following purposes. It is recommended to connect the brake resistor.

- Frequent rapid deceleration
- Continuous regenerative load
- Low-inertia machines
- Machines that is disallowed for torque fluctuations

Parameter Code (Address)	Name	Description	Default (Range)
F10.12 (0x0A0C) STOP	DC bus overvoltage suppression point	V/F SVC FVC PMVF PMSVC PMFVC Set the DC bus voltage value that triggers the overvoltage suppression function.	T3: 750 V S2: 370 V (0 V - overvoltage point) T3 overvoltage point: 820 V S2 overvoltage point: 400 V

Note: The Default of this parameter depends on the drive model.

When the DC bus voltage reaches or exceeds F10.12 [Bus overvoltage Suppression Point] during the running, the drive will adjust the output frequency automatically to suppress the rise of bus voltage and avoid the drive from jumping to E. ou [overvoltage fault]. The schematic of overvoltage suppression function is shown as follows.

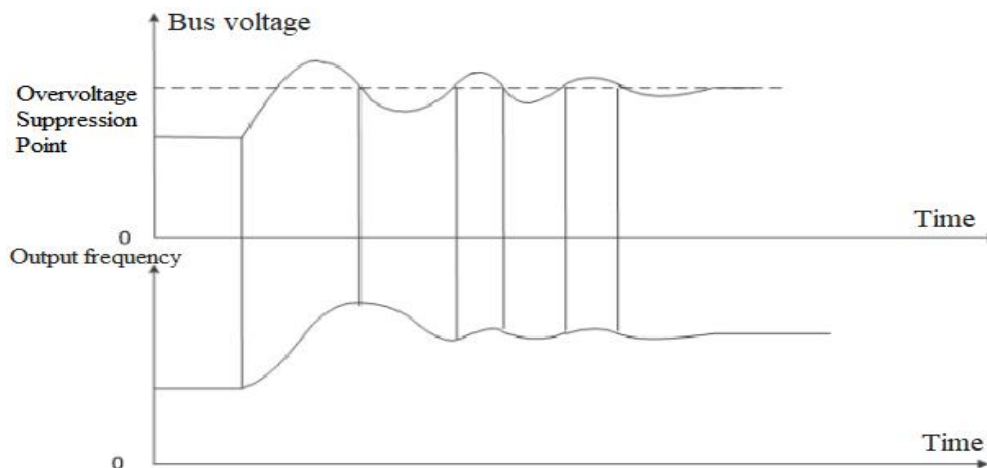

Schematic of Over-pressure Suppression Function

Parameter Code (Address)	Name	Description	Default (Range)
F10.13 (0x0A0D) RUN	DC bus overvoltage suppression gain	V/F SVC FVC PMVF PMSVC PMFVC Set the response effect of overvoltage suppression.	100.0% (0.0%~500.0%)

Adjust F10.13 [DC bus overvoltage Suppression Gain] to adjust the effect of over-pressure suppression function. When this parameter is set as 0, it indicates that the overvoltage suppression function is invalid.

Parameter Code (Address)	Name	Description	Default (Range)
F10.14 (0x0A0E) RUN	Dynamic brake enabling	V/F SVC FVC PMVF PMSVC PMFVC Set whether the dynamic brake function is enabled. 0: OFF	2 (0~2)

		1: Enabled with overvoltage suppression disabled 2: Enabled with overvoltage suppression enabled	
--	--	---	--

This parameter sets whether the dynamic brake function is enabled.

0: OFF

No matter how high the bus voltage, the drive does not implement dynamic brake control for the motor.

1: Enable dynamic brake, and disable the overvoltage suppression function.

When the bus voltage exceeds the dynamic brake action voltage, the drive will implement the dynamic brake control for the motor, and disable the overvoltage suppression function.

2: Enable dynamic brake and overvoltage suppression function at the same time.

When the bus voltage exceeds the dynamic brake action voltage, the drive will implement dynamic brake control for the motor , and enable the overvoltage suppression function at the same time.

Note: In this parameter setting, the priority of turning on or turning off the overvoltage suppression function is above the F10.11 [Bus overvoltage Suppression Function].

Parameter Code (Address)	Name	Description	Default (Range)
F10.15 (0x0A0F) RUN	Dynamic brake action voltage	V/F SVC FVC PMVF PMSVC PMFVC Set the dynamic braking action voltage. The dynamic brake works when the bus voltage is higher than this value.	T3: 740 V S2: 360 V (0 V - overvoltage point) T3 overvoltage point: 820 V S2 overvoltage point: 400 V

When the DC bus voltage of the drive increases and exceeds the F10.15 [Dynamic Braking Action Voltage], the drive will start the dynamic brake action. For those models without built-in braking resistor, if you need to use dynamic brake function, please buy an optional brake resistor.

Note: When using the dynamic brake function, please disable the overvoltage suppression function and set F10.11 to 0. Otherwise, overvoltage suppression may inhibit the increase of bus voltage and fail to reach the dynamic brake action point.

Parameter Code (Address)	Name	Description	Default (Range)
F10.16 (0x0A10) STOP	DC bus under-voltage suppression function	V/F SVC FVC PMVF PMSVC PMFVC Limits the DC bus voltage decrease when the bus voltage is lower than the under-voltage suppression point by automatically adjusting the operating frequency to prevent under-voltage fault. 0: OFF 1: ON	0 (0~1)

Note: The overvoltage suppression function is active in any control mode.

When the DC bus voltage of the drive reaches or is lower than F10.17 [DC Bus Under-voltage Suppression Point], the drive will adjust output frequency automatically to suppress the reduction of DC bus voltage to ensure that the drive does not trigger E. Lu2 [Under-voltage fault] due to low DC bus voltage.

0: OFF

1: ON

Parameter Code (Address)	Name	Description	Default (Range)
F10.17 (0x0A11) STOP	DC bus under-voltage suppression point	V/F SVC FVC PMVF PMSVC PMFVC Set the DC bus voltage value that triggers the under-voltage suppression function.	T3: 430 V S2: 240 V (0 V - overvoltage point) T3 overvoltage point: 820 V S2 overvoltage point: 400 V

Note: The Default of this parameter depends on the drive model.

When the DC bus voltage of the drive reaches or is lower than F10.17 [DC Bus Under-voltage Suppression Point], the drive will adjust output frequency automatically to suppress the reduction of bus voltage to ensure that the drive does not trigger E. Lu2 [Under-voltage fault] due to low DC bus voltage.

Parameter Code (Address)	Name	Description	Default (Range)
F10.18 (0x0A12) RUN	DC bus under-voltage suppression gain	V/F SVC FVC PMVF PMSVC PMFVC Sets the response effect of under-voltage suppression.	100.0% (0.0%~500.0%)

Adjust F10.18 [Bus Under-voltage Suppression Gain] to adjust the effect of under-voltage suppression function, When this parameter is set as 0, that indicates the under-voltage suppression function is turned off.

Parameter Code (Address)	Name	Description	Default (Range)
F10.19 (0x0A13) STOP	DC bus under-voltage protection point	V/F SVC FVC PMVF PMSVC PMFVC Sets the allowable lower limit of bus voltage. The drive will report the under-voltage fault when the bus voltage is lower than this value.	T3: 320 V S2: 190 V (0 V - overvoltage point) T3 overvoltage point: 820 V S2 overvoltage point: 400 V

This parameter sets the lower voltage limit allowed by the DC bus voltage during the normal operation of the drive. For some scenarios where the power grid is low, the under-voltage protection level can be appropriately reduced to ensure the normal operation of the drive.

Note: When the grid voltage is too low, the output torque of the motor will reduce. For constant power load and constant torque load, when grid voltage is too low, the input and output current of the drive will increase, thus reducing the operation reliability of the drive.

Group F10.2x: Auxiliary Protection

Parameter Code (Address)	Name	Description	Default (Range)
F10.20 (0x0A14) STOP	Input and output phase loss protection selection	V/F SVC FVC PMVF PMSVC PMFVC Sets whether the input and output phase loss protection function is enabled. LED"0": Output phase loss protection function 0: OFF 1: ON LED"00": Input phase loss protection function 0: OFF 1: Enabled. The drive reports alarm A. iLF and keep running when input phase loss is detected. 2: Enabled. The drive reports alarm E. iLF and free stop when input phase loss is detected.	0021 (0000~1121)

Sets whether the input and output phase loss protection function is enabled.

LED"0": Output phase loss protection selection

0: OFF, output phase loss protection function is not active. This function cannot be turned off in the process of DC braking and vector pre-excitation.

1: ON, the function of output phase loss protection is active, when the output phase loss is detected, the fault E.oLF will be reported, the motor will free stop.

LED"00": Input phase loss protection selection

0: OFF, Input phase loss protection function is not active.

1: Enabled, when the input phase loss is detected, the fault A.iLF will be reported, the motor will keep running.

2: Enabled, when the input phase loss is detected, the fault E. iLF will be reported, the motor will free stop.

Parameter Code (Address)	Name	Description	Default (Range)
F10.21 (0x0A15) STOP	Input phase loss threshold	V/F SVC FVC PMVF PMSVC PMFVC Set the voltage detection percentage for the input phase loss detection function. 100% corresponds to the rated bus voltage.	10.0% (0.0%~30.0%)

Set the voltage detection percentage for the input phase loss detection function. 100% corresponds to the rated DC bus voltage.

Note: When the gird motor fluctuates greatly, the value can be increased appropriately to prevent false input phase loss warning.

Parameter Code (Address)	Name	Description	Default (Range)
F10.22 (0x0A16) STOP	Grounding short circuit protection selection	V/F SVC FVC PMVF PMSVC PMFVC Set whether the ground short circuit protection function for the drive output and cooling fan is enabled. LED"0": Output short-to-ground protection function 0: Disabled 1: Detection upon power-on 2: Pre-running detection LED"00": Fan short-to-ground protection function 0: OFF 1: ON LED"000": Power short-to-ground protection function 0: OFF 1: ON	0111 (0000~0112)

Set whether the ground short circuit protection function for the drive output and cooling fan is enabled.

LED"0": Output short-to-ground protection function

0: OFF, Output short-to-ground protection function is turned off.

1: Detection upon power-on, The output short-to-ground protection function is turned on, when the drive outputs short circuit to ground is detected, the E. SG [Output short circuit to ground fault] will be reported.

2: Detection before operation, turn on the output short-to-ground protection function before operating at each time.

LED"00": Fan short-to-ground protection function

0: OFF, fan short-to-ground protection function is turned off.

1: ON, the fan short-to-ground protection function is turned on. When the fan short circuit to ground is detected, the E. FSG [Fan short circuit to ground fault] will be reported.

LED"000": Power short-to-ground protection function

0: OFF, power short-to-ground protection function is turned off.

1: ON, power short-to-ground protection function is turned on. When the power short circuit to ground is detected, the E. PoS [Power short circuit to ground fault] will be reported.

Note:

- When turning on the pre-running short-to-ground detection, the synchronous machine cannot be started in rotation.
- In the rotation process of the synchronous machine, the drive will misreport short circuit to the ground fault after power-on.

Parameter Code (Address)	Name	Description	Default (Range)
F10.23 (0x0A17) RUN	Fan ON/OFF control selection	V/F SVC FVC PMVF PMSVC PMFVC Set the running mode of the drive's cooling fan. 0: The fan works after the drive is powered on. 1: The fan runs according to the temperature after the drive stop, and runs when the drive is running. 2: After the drive stop, the fan stops after the time set by F10.24, and runs according to the temperature.	1 (0~2)

Set the running mode of drive cooling fan.

0: The fan runs after the drive is powered on Regardless of the module temperature, the fan will run after the drive is powered on.

1: The fan runs according to the temperature after the drive stop, and runs when the drive is running. The fan runs according to the temperature when the drive shuts down. If the temperature is above 50°C, the fan will run, otherwise it will stop after a delay time of 30 s. When the drive is running, the fan will run after a delay time of 1 s.

2: After the drive stop, the fan stops, and runs according to the temperature. The fan runs according to the temperature when the drive is running. If the temperature is above 50°C, the fan will run immediately, otherwise it will stop after a delay time of 30 s. After the drive stop, the fan will stop after a delay time of 30 s.

Note: Correct use of this function can effectively prolong the service life of the cooling fan.

Parameter Code (Address)	Name	Description	Default (Range)
F10.24 (0x0A18) STOP	Fan control delay time	V/F SVC FVC PMVF PMSVC PMFVC Set the time from releasing the deactivation command to stop of the cooling fan.	30.00s (0.00s~60.00s)

Sets the time from releasing the deactivation command to stopping of the cooling fan. After the drive stops running, the fan will stop through this time.

Parameter Code (Address)	Name	Description	Default (Range)
F10.25 (0x0A19) RUN	Drive overheat oH1 warning detection level	V/F SVC FVC PMVF PMSVC PMFVC Set the temperature value for overheat warning of the drive. Overheat warning is Valid if the temperature is higher than this value.	80.0°C (0.0°C~100.0°C)

Sets the temperature value for overheat warning of drive. A.OH1 [Overheat Warning] is Valid if the temperature of C00.12 radiator is higher than this value.

Parameter Code (Address)	Name	Description	Default (Range)
F10.26 (0x0A1A) RUN	Motor overheat protection selection (extension card)	V/F SVC FVC PMVF PMSVC PMFVC Set the motor overheat protection when an IO extension card is used. LED"0": Motor temperature sensor type 0: PT1000 1: KTY84	0x01 (0x00~0x01)

This parameter sets the motor overheat protection when an IO extension card is used.

LED"0": Motor temperature sensor type

0: PT1000, corresponding to the motor with PT1000 temperature sensor.

1:KTY84, corresponding to the motor with KTY84 temperature sensor.

Note: This function should be used with IO extension card, the type of motor temperature sensor should correspond with the motor temperature sensor.

F10.26 is active when the dip switch of IO extension card is set to KTY. The PT100 is active when the dip switch of IO extension card is set to PT100.

Parameter Code (Address)	Name	Description	Default (Range)
F10.27 (0x0A1B) RUN	Motor overheat alarm level (extension card)	V/F SVC FVC PMVF PMSVC PMFVC Set the temperature value of the motor for overheat fault. Overheat fault is reported if the temperature is higher than this value.	110.0°C (0.0°C~200.0°C)

Sets the temperature value of the motor for overheat fault, if the temperature is higher than this value, E.oH3 [Overheat fault] is reported if the temperature is higher than this value.

Parameter Code (Address)	Name	Description	Default (Range)
F10.28 (0x0A1C) RUN	Motor overheat warning level (extension card)	V/F SVC FVC PMVF PMSVC PMFVC Set the temperature value of the motor for overheat warning. Overheat warning is sent if the temperature is higher than this value.	90.0°C (0.0°C~F10.27)

Set the temperature value of the motor for overheat warning, if the temperature is higher than this value, A. oH3 [Overheat warning] is reported motor will continue to operate.

Group F10.3x: Load Detection Protection

Load detection judgment:

The load warning detection mode and the warning mode of the drive should be used with two parameters of load detection level and load warning detection time.

Parameter Code (Address)	Name	Description	Default (Range)
F10.32 (0x0A20) STOP	Load warning detection setting	<p>V/F SVC FVC PMVF PMSVC PMFVC Set the load warning detection mode and the warning mode of the drive. LED"0": Load warning detection 1 setting 0: Do not detect 1: Detect overload 2: Detect overload only at constant speed 3: Detect underload 4: Detect underload only at constant speed LED"00": warning setting for load warning detection 1 0: Continue running and report A. LD1 1: free stop, and report E. LD1 LED"000": Load warning detection 2 setting 0: Do not detect 1: Detect overload 2: Detect overload only at constant speed 3: Detect underload 4: Detect underload only at constant speed LED"0000": Warning setting for load warning detection 2 0: Continue running and report A. LD2 1: Free stop, and report E. LD2</p>	0000 (0000~1414)

Parameter Code (Address)	Name	Description	Default (Range)
F10.33 (0x0A21) STOP	Load warning detection level 1	<p>V/F SVC FVC PMVF PMSVC PMFVC Set the detection value of load warning 1. Under V/F control, the value of 100% corresponds to the motor rated current. In the case of vector control, the value of 100% corresponds to the rated output torque of the motor</p>	130.0% (0.0%~200.0%)
F10.34 (0x0A22) STOP	Load warning detection time 1	<p>V/F SVC FVC PMVF PMSVC PMFVC Set the duration of detecting load warning 1. The load warning 1 will last for this time after the load reaches the detection level.</p>	5.0s (0.0s~60.0s)

Set the related parameters of load warning 1.

When the drive is running under the V/F control mode, 100.0% corresponds to the motor rated current. Under the vector control mode, motor output torque is used as load warning judgment value, and 100.0% corresponds to the rated output torque of the motor.

Load warning judgment value 1 in F10.34 [Load Warning Detection Time] should be compared with F10.33 [Load Warning Detection Level]. The motor will make corresponding action according to the set points in LED"0" and LED"00" of F10.32 [Load Warning Detection Setting].

When the function of terminal Y is selected as 27 [Overload warning detection] or 28 [Underload warning detection], the drive will output warning signal through the terminal Y.

Parameter Code (Address)	Name	Description	Default (Range)
F10.35 (0x0A23) STOP	Load warning detection level 2	V/F SVC FVC PMVF PMSVC PMFVC Set the detection value of load warning 2. Under V/F control, the value of 100% corresponds to the motor rated current. In the case of vector control, the value of 100% corresponds to the rated output torque of the motor	30.0% (0.0%~200.0%)
F10.36 (0x0A24) STOP	Load warning detection time 2	V/F SVC FVC PMVF PMSVC PMFVC Set the duration of detecting load warning 2. The load warning 2 will last for this time after the load reaches the detection level.	5.0s (0.0s~60.0s)

Set the related parameters of load warning 2.

When the drive is running under the V/F control mode, 100.0% corresponds to the motor rated current. Under the vector control mode, motor output torque is used as load warning judgment value, and 100.0% corresponds to the rated output torque of the motor.

Load warning judgment value 2 in F10.36 [Load Warning Detection Time] should be compared with F10.35 [Load Warning Detection Level]. The motor will make corresponding action according to the set points in LED"000" and LED"0000"s of F10.32 [Load Warning Detection Setting].

When the function of terminal Y is selected as 27 [Overload warning detection] or 28 [Underload warning detection], the drive will output warning signal through the terminal Y.

Group F10.4x: Stall Protection

Parameter Code (Address)	Name	Description	Default (Range)
F10.40 (0x0A28) STOP	Protection against excessive speed deviation	V/F SVC FVC PMVF PMSVC PMFVC Set the warning detection when the deviation between the set speed and feedback speed of the motor is excessive. Select the warning detection mode and alarm mode. LED"0": Detection selection 0: Do not detect 1: Detect only at constant speed 2: Always detect LED"00": Alarm selection 0: Free stop and report fault 1: Alarm and keep running	0000 (0000~0012)

Set the warning detection mode and alarm mode when the deviation between the set speed and feedback speed of the motor is excessive, using it with F10.41[Excessive Speed Deviation Detection Threshold] and F10.42 [Excessive Speed Deviation Detection Time].

LED"0": Detection selection

0: Do not detect, turn off the protection function for excessive speed deviation.

1: Detect only at constant speed, turn on the protection function for excessive speed deviation only when running at constant speed.

2: Always detect, turn on the protection function for excessive speed deviation when the motor is under the acceleration, deceleration and constant speed control.

LED"00": Fault selection

0: Free stop and report the fault alarm E.DEF

1: Continue running and report fault alarm A. DEF

Parameter	Name	Description	Default
-----------	------	-------------	---------

Code (Address)			(Range)
F10.41 (0x0A29) STOP	Excessive speed deviation detection threshold	V/F SVC FVC PMVF PMSVC PMFVC Set the value for detecting excessive speed deviation. The value of 100% corresponds to F01.10 [Maximum frequency].	10.0% (0.0%~60.0%)
F10.42 (0x0A2A) STOP	Excessive speed deviation detection time	V/F SVC FVC PMVF PMSVC PMFVC Set the duration for detecting excessive speed deviation. If the deviation between the set speed and the feedback speed is greater than F10.41 and lasts for this time, the excessive speed deviation is detected and warning .	2.0s (0.0s~60.0s)

Note: The speed deviation detection threshold of 100% corresponds to F01.10 [Maximum Frequency].

When the deviation between the speed feedback value and the speed set point corresponding to the percentage value of F01.10 [Maximum Frequency] is greater than F10.41 [Excessive Speed Deviation Detection Threshold] within the set time of F10.42 [Excessive Speed Deviation Detection Time], the motor will respond according to F10.40 [Protection Against Excessive Speed Deviation].

Parameter Code (Address)	Name	Description	Default (Range)
F10.43 (0x0A2B) STOP	Speed Surge Protection	V/F SVC FVC PMVF PMSVC PMFVC Set the warning detection mode and alarm mode in the case of motor speed surge. LED"0": Detection selection 0: Do not detect 1: Detect only at constant speed 2: Always detect LED"00": Alarm selection 0: Free stop and report fault 1: Alarm and keep running	0002 (0000~0012)

Set the warning detection mode and alarm mode when the feedback speed of the motor is excessive, using it with F10.44 [Over-speed Detection Threshold] and F10.45 [Over-speed Detection Time].

LED"0": Detection selection

0: Do not detect, turn off the over-speed protection function.

1: Detect only at constant speed, turn on the protection function only when running at constant speed.

2: Always detect, turn on the over-speed protection function when the motor is under the acceleration, deceleration and constant speed control.

LED"00": Fault selection

0: Free stop and report the fault alarm E.SPD

1: Continue running and report fault alarm A. SPD

Parameter Code (Address)	Name	Description	Default (Range)
F10.44 (0x0A2C) STOP	Speed surge detection threshold	V/F SVC FVC PMVF PMSVC PMFVC Set the value for detecting speed surge. The value of 100% corresponds to F01.10 [Maximum frequency].	110.0% (0.0%~150.0%)
F10.45 (0x0A2D) STOP	Speed surge detection time	V/F SVC FVC PMVF PMSVC PMFVC Sets the duration for detecting speed surge. If the feedback speed is greater than F10.44 and lasts for this time, the speed surge is detected and warning .	0.100s (0.000s~2.000s)

Note: The over-speed detection threshold of 100% corresponds to F01.10 [Maximum Frequency].

When the speed feedback value corresponding to the percentage value of F01.10 [Maximum Frequency] is greater than F10.44 [Over-speed Detection Threshold] within the setting time of F10.45 [Over-speed Detection Time], the motor will make corresponding action according to F10.43 [Over-speed Protection Action].

Group F10.5x: Fault Recovery and Motor Overload

Fault Recovery F10.50~F10.52

When the drive detects a temporary fault and does not want to stop the machine, the fault self-recovery function is used to reset the fault automatically. When the times of fault self-recovery exceeds the set point within the set time, the drive will stop after detecting a fault. At this time, it is necessary to reset the fault manually after troubleshooting.

Dangerous! Do not use the fault self-recovery function when the winch lifting load or the fault cannot be automatically restored. Otherwise, that may result in personal injury accident.

Parameter Code (Address)	Name	Description	Default (Range)
F10.50 (0x0A32) STOP	Fault Self-Recovery Times Setting	V/F SVC FVC PMVF PMSVC PMFVC Set how many times fault self-recovery is allowed. Note: The value of 0 indicates that the fault self-recovery function is disabled, while any other value indicates that the function is enabled.	0 (0~10)

Note: When the parameter is set as 0, it indicates that the fault self-recovery function is disabled.

During the start of the fault self-recovery function, if the fault occurs in the process of shut-down deceleration, the fault self-recovery will not be performed.

During the start of the fault self-recovery function, if the undervoltage fault occurs during the operation, the drive will jump to A. Lu1 warning and enter the stop state.

During the fault self-recovery, if the non-self-recovery fault occurs, the drive will enter the fault state and not perform the self-recovery.

Parameter Code (Address)	Name	Description	Default (Range)
F10.51 (0x0A33) STOP	Fault self-recovery interval	V/F SVC FVC PMVF PMSVC PMFVC Set the waiting time between a fault of the drive and the follow-up reset.	1.0s (0.0s~100.0s)

Sets the waiting time between a fault of the drive and the follow-up reset. The Keypad will display the character of the fault in this time, but the running indicator light is still lighten.

Parameter Code (Address)	Name	Description	Default (Range)
F10.52 (0x0A34) READ	Times of Fault Recovery	V/F SVC FVC PMVF PMSVC PMFVC Indicates how many times fault self-recovery has been performed. This parameter is read only.	0

Indicates how many times fault self-recovery has been performed, it's convenient for user to confirm the usage state of the fault self-recovery function, this parameter is read only.

Note: Each time the fault self-recovery is executed, the value is increased by 1. When the value is equal to F10.50 [Fault Self-Recovery Times Setting], the fault will be detected if a self-recovery fault is triggered, and the fault recovery is no longer performed.

During the fault self-recovery, if the non-self-recovery fault results in the stop, the value will be reset to 0.

If the self-recovery fault occurs and other faults will not be triggered in 10 minutes, the value will be reset to 0.

Motor Overload Protection F10.55~F10.59

Parameter Code (Address)	Name	Description	Default (Range)
F10.55 (0x0A37) RUN	Motor Overload Model	V/F SVC FVC PMVF PMSVC PMFVC 0: Ordinary motor 1: Frequency conversion motor (50 Hz) 2: Frequency conversion motor (60 Hz) 3: Motor without cooling fan	0 (0~3)
F10.56 (0x0A38) STOP	Motor Insulation Class	V/F SVC FVC PMVF PMSVC PMFVC 0: Insulation class A 1: Insulation class E 2: Insulation class B 3: Insulation class F 4: Insulation class H 5: Special class S	3 (0~5)
F10.57 (0x0A39) STOP	Motor Working System	V/F SVC FVC PMVF PMSVC PMFVC 0-1: S1 working system (continuous working) 2: S2 working system 3-9: Corresponding to S3 - S9	0 (0~9)
F10.58 (0x0A3A) STOP	Motor Overload Start Threshold	V/F SVC FVC PMVF PMSVC PMFVC The starting threshold of motor overload. When the actual current is greater than this value, the overload increases on a cumulative basis.	105.0% (0.0%~130.0%)
F10.59 (0x0A3B) STOP	Motor Overload Current Coefficient	V/F SVC FVC PMVF PMSVC PMFVC Calculated motor overload current = actual current * motor overload current coefficient.	100.0% (0.0%~250.0%)

Long-term overload operation of the motor will lead to extreme overheating, the heat parameter and the heat loss parameter determines the motor temperature rise, if the motor overload protection and motor current show inverse time characteristic curve, this is related to motor operation frequency. When setting F10.59 = 100.0%, the overload protection curve is shown as follows.

The comparison of the overload curve of each level at 50 Hz

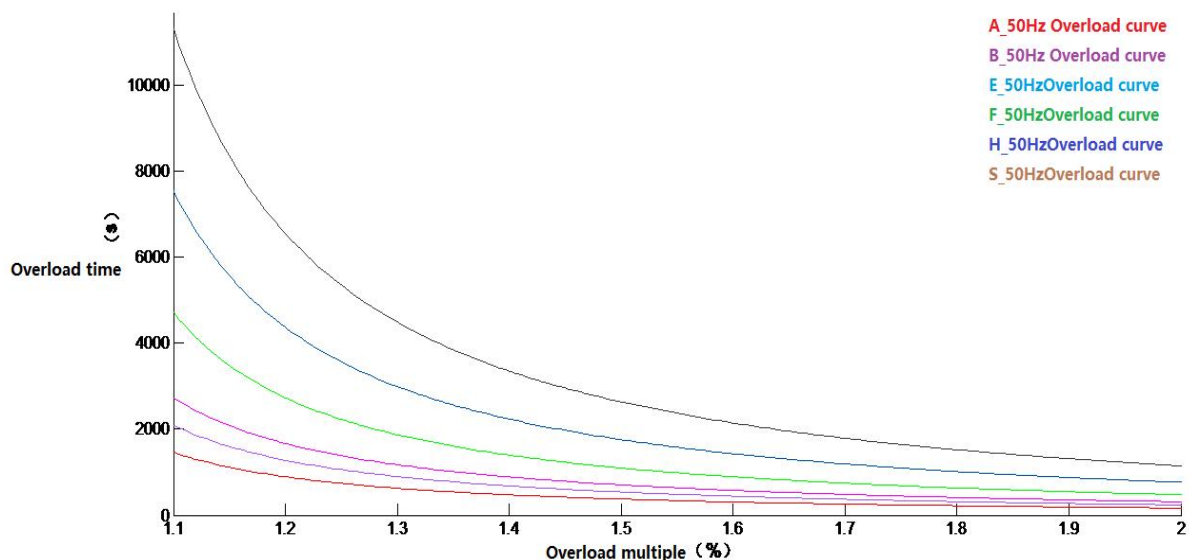

The overload time table of key points of each level at 50 Hz

Motor overload protection Time (min)		(Calculated motor overload current/rated current) × 100%		
		110%	150%	200%
Insulation Class	F	75	16	3.5

The overload protection curve under different frequency when the default is F level.

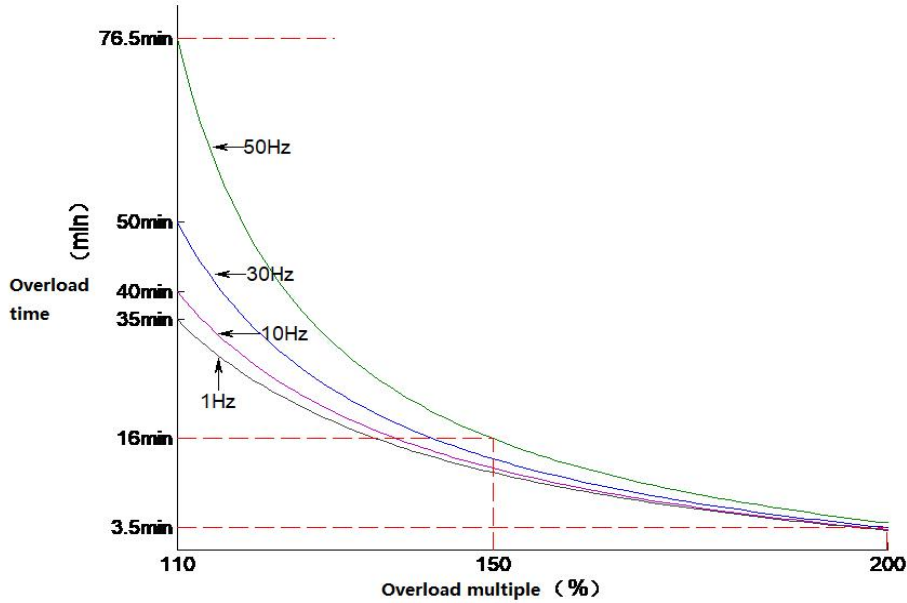

Note: Users need to set the industrial control according to the actual condition of the motor, and set the values of F10.55~F10.59 correctly, to effectively protect the motor.

When a drive operates with multiple motors in parallel, the thermal relay protection function will not work, to protect motors effectively, please install a thermal relay at incoming line end of each motor.

11.13 Group F11: Keypad Parameters

Group F11.0x: Button Operation

◇ F11.00: Button Lock Selection

Parameter Code (Address)	Name	Description	Default (Range)
F11.00 (0x0B00) RUN	Parameters and button lock selection	V/F SVC FVC PMVF PMSVC PMFVC	0 (0~3)

0: Not locked

Parameters and button lock function is not active.

1: Function parameter is locked

It is disabled to modify the set points of all the functional parameters (except for the specific function codes of up and down buttons, which can be modified by the up and down buttons). You cannot enter the parameter modification interface through the keypad, but can select the monitoring value by the shift keypad. All button functions on the keypad are not locked.

2: Function parameter and button lock

Lock the set points of all the function parameters. You can neither enter the parameter modification interface through the keypad, nor select the keypad monitoring value. Do not modify the parameter. Lock all buttons on the keypad except RUN/STOP/JOG/PRG.

3: Function parameter and button lock

Lock the set points of all the function parameters, and disable modifying parameters. At the same time, lock all the buttons on the keypad except PRG.

Note:

- How to unlock dual-line digital tube keypad: After pressing the PRG menu button, the first line of the keypad will display CodE. Then you can directly enter the user's password (F11.01-User Password) in the second line by pressing the SET button to unlock it.
- How to unlock single-line digital tube keypad: The single-line digital tube Keypad will display CodE after pressing the PRG menu button, then press the "SET" button, the digital tube will display flashing input cursor, enter the user password (F11.01-User Password) through the up and down buttons, and then press the SET button again to confirm, then you can unlock.
- The user password is a protective parameter set to protect the drive parameters from tampering. After setting the password, keep it in mind to avoid the inconvenience when you want to change the parameters later.
- After unlocking, entering the monitoring interface will exit the unlock. If you want to return to the parameter interface, you need to enter the password again.

✧ **F11.00: Button Lock Password**

Parameter Code (Address)	Name	Description	Default (Range)
F11.01 (0x0B01) RUN	Button lock password	V/F SVC FVC PMVF PMSVC PMFVC Set the button lock password.	0 (0~65535)

✧ **F11.02: Keypad Multi-Functional Button Selection**

Parameter Code (Address)	Name	Description	Default (Range)
F11.02 (0x0B02) STOP	Keypad multi-function button selection	V/F SVC FVC PMVF PMSVC PMFVC	0 (0~7)

0: Invalid

1: Reverse running button

2: Forward jogging button

3: Reverse jogging button

4: Switching between the keypad command channel and the terminal command channel

5: Switching between the keypad command channel and the communication command channel

6: Switching between the terminal command channel and the communication command channel

7: Switching between keypad, terminal and communication command channels

✧ **F11.03: Keypad STOP Button Setting**

Parameter Code (Address)	Name	Description	Default (Range)
F11.03 (0x0B03) STOP	Keypad stop button setting	V/F SVC FVC PMVF PMSVC PMFVC	0 (0~2)

0: Non-Keypad control mode is disabled When the signal of the non-keypad control mode is valid, the STOP button cannot be used as a stop button to stop the drive.

1: Non-Keypad control mode stop the drive by the stop mode. When the signal of the non-keypad control mode is valid, the keypad STOP button can be used as a stop button to stop the drive by the stop mode set by [F07.10].

It can be used as a stop button, and the stop mode is the mode set by [F07.10].

2: Non-Keypad control mode stop the drive by free stop. When the signal of the non-keypad control mode is valid, the keypad

STOP button cannot be used as a stop button to stop the drive freely.

It can be used as a stop button, and the stop mode is free stop.

Note:

- If [F11.03] is selected as 1 or 2, press the keypad stop button to stop the motor under the terminal control or RS485 communication control, the drive will be locked in the stop state. If you want to restart the drive, you should sent the stop command from the selected run command channel, and the drive cannot run until the locked state is released.

✧ **F11.04: Function of Up/Down Button (Knob) in Status Interface**

Parameter Code (Address)	Name	Description	Default (Range)
F11.04 (0x0B04) STOP	Function of up/down button (knob) in status interface	V/F SVC FVC PMVF PMSVC PMFVC	0011 (0000~0213)

LED"0": Keypad up/down button used for modification

0: Invalid

1: Adjust F01.09 frequency set by keypad. Modify the set point of parameter [F01.09] promptly by keypad up/down button.

2: Adjust F13.01 set by PID keypad. Modify the set point of parameter [F13.01] promptly by keypad up and down button.

3: Modify parameter number settings by keypad up and down buttons. Modify the set point of [Fxx.yy] corresponding to the parameter F11.05 promptly by keypad up and down button.

LED"00": Storage after power-off

0: Frequency is not stored after power-off

1: Frequency is stored after power-off

Selects whether the drive saves the modified value to the corresponding parameter during power failure after the parameter is promptly modified by the keypad up and down button.

LED"000": Action limit

0: Adjustable during operation and stopping

1: Adjustable only during operation, and maintained during stopping

2: Adjustable during running; reset during stop

LED"0000": Reserved

Note:

- LED"00": Select whether the changed data is stored in an EEPROM.

✧ **F11.05: Parameter Code Setting Quick Change with Up/Down Button**

Parameter Code (Address)	Name	Description	Default (Range)
F11.05 (0x0B05) RUN	Parameter code setting quick change with up/down button	V/F SVC FVC PMVF PMSVC PMFVC	0109 (0000~2999)

Modifying parameter number settings by keypad up and down button

LED"0" and LED"00": Set yy in function parameter number Fxx.yy to 00-99.

LED"000" and LED"0000": Set xx in function parameter number Fxx.yy to 00-29.

Note:

- F11.04 is active when the LED"0" is 3. For example, when F11.05 = 0342, the up and down buttons of the keypad can be used to modify the point value of [F03.42] promptly.

◇ **F11.06: Keypad Command Button Selection**

Parameter Code (Address)	Name	Description	Default (Range)
F11.06 (0x0B06) STOP	Keypad command button selection	V/F SVC FVC PMVF PMSVC PMFVC	0000 (0000~2122)

LED"0": Internal and external keypad button commands

(Run commands, and stop/reset commands)

0: External commands takes precedence. When external commands are valid, internal ones are invalid

1: Internal commands takes precedence. When internal commands are valid, external ones are invalid

2: Both internal and external commands are valid, and the stop/reset command takes precedence

LED"00": Reserved

LED"000": Reserved

LED"0000": Keypad test (successful communication rate)

Group F11.1x: Status Interface Loop Monitoring

◇ **F11.10: Function of Left/Right Buttons in Status Interface**

Parameter Code (Address)	Name	Description	Default (Range)
F11.10 (0x0B0A) STOP	Function of left/right buttons in status interface	V/F SVC FVC PMVF PMSVC PMFVC	0011 (0000~0011)

LED"0": The left button is used to adjust the first line of monitoring 0: Invalid, 1: Valid

LED"00": The right button is used to adjust the second line of monitoring 0: Invalid, 1: Valid

Note:

- When it is invalid, the current loop parameter will be displayed, and the loop parameter 1 will be displayed after power-on again.
- When the left/right button is invalid, when pressing the left/right button, the monitoring will not switch. When the left/right button function selection is changed to active, the monitoring quantity changes immediately.

◇ **F11.11: Loop Parameter 1 for the Keypad First Line**

Parameter Code (Address)	Name	Description	Default (Range)
F11.11 (0x0B0B) RUN	Loop parameter 1 for the keypad first line	V/F SVC FVC PMVF PMSVC PMFVC Set the parameter display contents of single-line keypad and dual-line keypad.	0000 (0000~0763)

◇ F11.12: Loop Parameter 2 for the Keypad First Line

Parameter Code (Address)	Name	Description	Default (Range)
F11.12 (0x0B0C) RUN	Loop parameter 2 for the keypad first line	V/F SVC FVC PMVF PMSVC PMFVC Set the parameter display contents of single-line keypad and dual-line keypad.	0001 (0000~0x0763)

◇ F11.13 Loop Parameter 3 for the Keypad First Line

Parameter Code (Address)	Name	Description	Default (Range)
F11.13 (0x0B0D) RUN	Loop parameter 3 for the keypad first line	V/F SVC FVC PMVF PMSVC PMFVC Set the parameter display contents of single-line keypad and dual-line keypad.	0002 (0000~0763)

◇ F11.14: Loop Parameter 4 for the Keypad First Line

Parameter Code (Address)	Name	Description	Default (Range)
F11.14 (0x0B0E) RUN	Loop parameter 4 for the keypad first line	V/F SVC FVC PMVF PMSVC PMFVC Set the parameter display contents of single-line keypad and dual-line keypad.	0011 (0000~0763)

◇ F11.15: Loop Parameter 1 for the Keypad Second Line

Parameter Code (Address)	Name	Description	Default (Range)
F11.15 (0x0B0F) RUN	Loop parameter 1 for the keypad second line	V/F SVC FVC PMVF PMSVC PMFVC Set the parameter display contents of the dual-line keypad.	0002 (0000~0763)

◇ F11.16: Loop Parameter 2 for the Keypad Second Line

Parameter Code (Address)	Name	Description	Default (Range)
F11.16 (0x0B10) RUN	Loop parameter 2 for the keypad second line	V/F SVC FVC PMVF PMSVC PMFVC Set the parameter display contents of the dual-line keypad.	0004 (0000~0763)

◇ F11.17: Loop Parameter 3 for the Keypad Second Line

Parameter Code (Address)	Name	Description	Default (Range)
F11.17 (0x0B11) RUN	Loop parameter 3 for the keypad second line	V/F SVC FVC PMVF PMSVC PMFVC Set the parameter display contents of the dual-line keypad.	0010 (0000~0763)

◇ F11.18: Loop Parameter 4 for the Keypad Second Line

Parameter Code (Address)	Name	Description	Default (Range)
F11.18	Loop parameter 4	V/F SVC FVC PMVF PMSVC PMFVC	0012

(0x0B12) RUN	for the keypad second line	Sets the parameter display contents of the dual-line keypad.	(0000~0763)
-----------------	-------------------------------	--	-------------

Keypad display parameters: Set the parameter display contents of the single-line keypad and dual-line keypad.

LED"0" and LED"00": Set yy in monitoring parameter number Cxx.yy to 00~63

LED"000" and LED"0000": Set xx in monitoring parameter number Cxx.yy to 00~07

Note:

- The parameters [F11.15~F11.18] only apply to dual-line keypads. The dual-line keypad switches the display parameters 1-4 on the second line of the keypad in order by the "▶" button.
- The single-line keypad switches the display parameters 1-4 on the second line of the keypad in order by long pressing the SET button (press "◀" key in the dual-line keypad). There is no memory function after switching the display content, and the content of display parameter 1 will be displayed by default after power-on.

Group F11.2x: Monitoring Parameter Control

◇ F11.20: Keypad Display Item Setting

Parameter Code (Address)	Name	Description	Default (Range)
F11.20 (0x0B14) RUN	Keypad display item setting	V/F SVC FVC PMVF PMSVC PMFVC	0002 (0000~111F)

LED"0": Output Frequency Display Selection

0: Target Frequency Display the target frequency currently controlling the motor

1: Operation frequency Display the output frequency of the drive after calculation.

2~F: Operating frequency filtering. The larger the value, the deeper the filtering

LED"00": Reserved

0: Invalid

1: The active power to remove loss on the stator resistance

LED"000": Power display dimension

0: Power display percentage (%) Display the output power of 100%, 100.0% is the motor rated power

1: Power display in kilowatt (kW) Display the actual value of output frequency

LED"0000": Reserved

◇ F11.21: Speed Display Coefficient

Parameter Code (Address)	Name	Description	Default (Range)
F11.21 (0x0B15) RUN	Speed display coefficient	V/F SVC FVC PMVF PMSVC PMFVC Set the display parameter for mechanical speed of the keypad monitor, 100.0% corresponds to rated speed of motor.	100.0% (0.0%~500.0%)

Note:

- Correct C00.05 mechanical speed value

✧ **F11.22: Power Display Coefficient**

Parameter Code (Address)	Name	Description	Default (Range)
F11.22 (0x0B16) RUN	Power display coefficient	V/F SVC FVC PMVF PMSVC PMFVC Set the display parameter rate for output power of keypad monitoring.	100.0% (0.0%~500.0%)

Note:

- Correct C00.10 output power value

✧ **F11.23: Monitoring Parameter Group Display Selection**

Parameter Code (Address)	Name	Description	Default (Range)
F11.23 (0x0B17) RUN	Monitoring parameter group display selection	V/F SVC FVC PMVF PMSVC PMFVC LED"0": Monitoring parameter mapping 0: AC310 1: AC70 LED"00": Group C05 display selection 0, 1: Parameters related to VF mode 2: Parameters related to VC mode LED"000": C00.40 - C00.63 display selection 0: Do not display 1: Display LED"0000": Communication fault code switching 0: Communication fault code table 1 (AC310) 1: Communication fault code table 2 (AC70) 2: Communication fault code table 3 (AC300)	0000 (0000~FFFF)

When then monitoring parameter mapping is AC70, the monitoring parameter address maps to 0x0Cxx (corresponding to AC70), to read the F12 parameter group at this time, the communication address should be changed to 0x1Cxx.

◇ F11.24: Monitoring Parameter Filtering Selection

Parameter Code (Address)	Name	Description	Default (Range)
F11.24 (0x0B18) RUN	Monitoring parameter filtering selection	V/F SVC FVC PMVF PMSVC PMFVC LED"0": Output current display filtering 0-F: The larger the value, the deeper the filtering LED"00": Reserved LED"000": Reserved LED"0000": Reserved	0002 (0000~000F)

◇ F11.25: Display during Motor Auto-tuning

Parameter Code (Address)	Name	Description	Default (Range)
F11.25 (0x0B19) STOP	Display during motor Auto-tuning	V/F SVC FVC PMVF PMSVC PMFVC 0: Show the status of Auto-tuning process 1: Do not the status of Auto-tuning process	0 (0~1)

◇ F11.27: Fault Self-Recovery Display Selection

Parameter Code (Address)	Name	Description	Default (Range)
F11.27 (0x0B1B) RUN	Fault self-recovery display selection	V/F SVC FVC PMVF PMSVC PMFVC LED"0": Display the fault upon fault self-recovery 0: Do not display 1: Display	0001 (0000~0001)

0: Do not display The keypad will not display the character of the fault in fault self-recovery interval, but the running indicator light is still lighten.

1:Display The keypad will display the character of the fault in fault self-recovery interval, but the running indicator light is still lighten.

Group F11.3x: Special Keypad Functions

◇ F11.31: Lower Voltage Limit of Keypad Potentiometer

Parameter Code (Address)	Name	Description	Default (Range)
F11.31 (0x0B1F) RUN	Lower voltage limit of keypad potentiometer	V/F SVC FVC PMVF PMSVC PMFVC	0.50V (0.00V~3.00V)

◇ F11.32: Corresponding Value to Lower Limit of Keypad Potentiometer

Parameter Code (Address)	Name	Description	Default (Range)
F11.32 (0x0B20) RUN	Corresponding value to lower limit of keypad potentiometer	V/F SVC FVC PMVF PMSVC PMFVC	0.00% (0.00%~100.00%)

✧ **F11.33: Upper Voltage Limit of Keypad Potentiometer**

Parameter Code (Address)	Name	Description	Default (Range)
F11.33 (0x0B21) RUN	Upper voltage limit of keypad potentiometer	V/F SVC FVC PMVF PMSVC PMFVC	2.80V (0.00V~3.00V)

✧ **F11.34: Value Corresponding to the Upper Limit of Keypad Potentiometer**

Parameter Code (Address)	Name	Description	Default (Range)
F11.34 (0x0B22) RUN	Corresponding value to upper limit of keypad potentiometer	V/F SVC FVC PMVF PMSVC PMFVC	100.00% (0.00%~100.00%)

Note: The parameters F11.30~F11.34 are only used to adjust the corresponding relations of optional outer single-line keypad potentiometer.

11.14 Group F12: Communication Parameters

Modbus communication is divided in two groups: This two groups of ports are independent on hardware.

Table 11.11 Modbus Communication Group

Modbus Communication Group	Interface	Master Parameters	Slave Parameters	Remarks
1	Terminals A+ and B-	F12.10-F12.19	F12.01-F12.09	
2	RJ45 (reticle)	F12.10-F12.19	F12.21-F12.29	This interface can be selected for Keypad communication. Models of 45 kW and above only support dual-line keypad communication.

The parameters F12.00 - F12.29 are used to set the drive when using the Modbus communication. Modbus protocol can be used for serial communication with the programmable logic controller (PLC).

Group F12.0x: Modbus Slave Parameters

✧ **F12.00: Master/Slave Selection**

Parameter Code (Address)	Name	Description	Default (Range)
F12.00 (0x0C00) STOP	Master/Slave selection	V/F SVC FVC PMVF PMSVC PMFVC Set the drive as the Modbus communication master or slave.	0 (0~1)

0: Slave When the drive is used as a slave, the communication address is set by [F12.01]. At this time, the drive accepts the command from the master on the communication network. According to the setting of parameter [F12.04], the drive selects whether to respond to data during write operation.

1: Master When the drive is used as a master, it will send the data of the master to the communication network through the broadcast command, and all slaves receive the commands from the master.

◇ F12.01: Modbus Communication Address

Parameter Code (Address)	Name	Description	Default (Range)
F12.01 (0x0C01) STOP	Modbus communication address	V/F SVC FVC PMVF PMSVC PMFVC Set the slave station address for communication of the drive.	1 (1~247)

Note: If this parameter is set as 0, the drive will not respond to the Modbus communication.

When the host computer (master station) communicates with the drive through Modbus, the slave station need to be set for the drive. Please set a value other than F12.01 = 0. The set slave station address should not conflict with other slave station equipment.

◇ F12.02: Communication Baud Rate Selection

Parameter Code (Address)	Name	Description	Default (Range)
F12.02 (0x0C02) STOP	Communication baud rate selection	V/F SVC FVC PMVF PMSVC PMFVC Set the baud rate of Modbus communication.	3 (0~6)

- 0:1200 bps
- 1:2400 bps
- 2:4800 bps
- 3:9600 bps
- 4:19200 bps
- 5:38400 bps
- 6:57600 bps

◇ F12.03: Modbus Communication Data Format

Parameter Code (Address)	Name	Description	Default (Range)
F12.03 (0x0C03) STOP	Modbus communication data format	V/F SVC FVC PMVF PMSVC PMFVC Selects the communication check used for Modbus communication.	0 (0~5)

Note: If the data format settings are different, communication may fail.

- 0: (N, 8, 1) No check, data bits: 8, stop bits: 1
- 1: (E, 8, 1) Even parity check, data bits: 8, stop bits: 1
- 2: (O, 8, 1) Odd parity check, data bits: 8, stop bits: 1
- 3: (N, 8, 1) No check, data bits: 8, stop bits: 2
- 4: (E, 8, 1) Even parity check, data bits: 8, stop bits: 2
- 5: (O, 8, 1) Odd parity check, data bits: 8, stop bits: 2

✧ **F12.04: Modbus Communication Transmission Response Processing**

Parameter Code (Address)	Name	Description	Default (Range)
F12.04 (0x0C04) RUN	Modbus communication transmission response processing	V/F SVC FVC PMVF PMSVC PMFVC Select the communication check used for Modbus communication.	0 (0~1)

This parameter selects whether the drive will respond to the write command from the host computer. If the host computer needs the drive to respond to the information, the drive will occupy the communication bus at different times. The host computer needs to save enough time to respond to the information when performing communication control. If the host computer does not need the drive to respond the information and only sends the command to the drive, select the write operation without response to improve the utilization efficiency of communication bus. This parameter is active for write operations only and has no effect on read operations.

0: Write with response

1: Write without response

✧ **F12.05: Modbus Communication Response Delay**

Parameter Code (Address)	Name	Description	Default (Range)
F12.05 (0x0C05) RUN	Modbus communication response delay	V/F SVC FVC PMVF PMSVC PMFVC Set the response delay of Modbus master-slave communication.	0ms (0ms~5000ms)

This parameter defines the interval between sending the response data to the host computer after receiving the data when the drive serve as the slave station of Modbus communication. If response delay is less than system processing time, the response delay is subject to the system processing time. If response delay is more than system processing time, the system need to wait the delay after processing the data, and will not send the data to host computer until the response delay time is up.

This parameter defines the drive as the master station of Modbus communication, the delay is the transmission interval of the master, and the minimum internal limit is 2.5 characters.

✧ **F12.06: Modbus Communication Timeout Fault Time**

Parameter Code (Address)	Name	Description	Default (Range)
F12.06 (0x0C06) RUN	Modbus communication timeout fault time	V/F SVC FVC PMVF PMSVC PMFVC Set the Modbus communication timeout fault time.	1.0s (0.1s~100.0s)

Modbus communication timeout fault time: If the interval between one communication and the next communication exceeds the communication timeout time, that will be considered that the communication has disconnection fault, and determine the action against disconnection fault by [F12.07].

✧ **F12.07: Communication disconnection Processing**

Parameter Code (Address)	Name	Description	Default (Range)
F12.07 (0x0C07)RUN N	Communication disconnection processing	V/F SVC FVC PMVF PMSVC PMFVC Select the stop mode of the motor when E. CE [Modbus communication fault] is detected.	0 (0~3)

Communication disconnection processing mode selection

0: Do not detect timeout fault

- 1: Alarm and free stop
 2: Warning and keep running
 3: Forced stop

Note:

- Forced stop command is set. The motor is forced to stop by decelerate mode, and it will no longer respond to running command before stop.

✧ **F12.08: Receiving Data (Address 0x3000) Zero Bias**

Parameter Code (Address)	Name	Description	Default (Range)
F12.08 (0x0C08) RUN	Receiving data (address 0x3000) zero bias	V/F SVC FVC PMVF PMSVC PMFVC Set the zero offset of 0x3000 communication address. When the final offset result is negative, it will be treated as zero.	0.00 (-100.00~100.00)

✧ **F12.09: Receive Data (Address 0x3000) Gain**

Parameter Code (Address)	Name	Description	Default (Range)
F12.09 (0x0C09) RUN	Receive data (address 0x3000) gain	V/F SVC FVC PMVF PMSVC PMFVC Set the 0x3000 communication address gain.	100.0% (0.0%~500.0%)

Group F12.1x: Modbus Master Parameters✧ **F12.10: Master Loop Transmission Parameter Selection**

Parameter Code (Address)	Name	Description	Default (Range)
F12.10 (0x0C0A) RUN	Master loop transmission parameter selection	V/F SVC FVC PMVF PMSVC PMFVC Set the master loop transmission parameter.	0031 (0000~CCCC)

LED"0", LED"00",LED"000",LED"0000"

- 0: Invalid
 1: Master run command
 2: Master given frequency
 3: Master output frequency
 4: Master upper limit frequency
 5: Master given torque
 6: Master output torque
 7: Reserved
 8: Reserved
 9: Master PID setting
 A: Master PID feedback
 B: Reserved

C: Active current component

✧ **F12.11: Custom Address Of Given Frequency**

Parameter Code (Address)	Name	Description	Default (Range)
F12.11 (0x0C0B) RUN	Custom address of given frequency	V/F SVC FVC PMVF PMSVC PMFVC Set the given frequency custom address.	0000 (0000~FFFF)

Note:

- 0 by default: Invalid. Other values indicate that this address priority is higher than the function code parameter address.

✧ **F12.12: Command Setting Custom Address Setting**

Parameter Code (Address)	Name	Description	Default (Range)
F12.12 (0x0C0C) RUN	Command setting custom address setting	V/F SVC FVC PMVF PMSVC PMFVC Set the command setting custom address.	0000 (0000~FFFF)

Note:

- 0 by default: Invalid. Other values indicate that this address priority is higher than the function code parameter address.

✧ **F12.13: Custom Address Of Forward Running Command**

Parameter Code (Address)	Name	Description	Default (Range)
F12.13 (0x0C0D) RUN	Custom address of forward running command	V/F SVC FVC PMVF PMSVC PMFVC Set the address of forward running command	0001 (0000~FFFF)

✧ **F12.14: Custom Address of Reverse Running Command**

Parameter Code (Address)	Name	Description	Default (Range)
F12.14 (0x0C0E) RUN	Custom address of reverse running command	V/F SVC FVC PMVF PMSVC PMFVC Set the address of reverse running command	0002 (0000~FFFF)

✧ F12.15: Custom Address of Stop Command

Parameter Code (Address)	Name	Description	Default (Range)
F12.15 (0x0C0F) RUN	Custom address of stop command	V/F SVC FVC PMVF PMSVC PMFVC Set the address of stop command.	0005 (0000~FFFF)

✧ F12.16: Custom Address of Reset Command

Parameter Code (Address)	Name	Description	Default (Range)
F12.16 (0x0C10) RUN	Custom address of reset command	V/F SVC FVC PMVF PMSVC PMFVC Set the address of reset command.	0007 (0000~FFFF)

✧ F12.19: Selection of Commands Sent by Master

Parameter Code (Address)	Name	Description	Default (Range)
F12.19 (0x0C13) RUN	Master sending command selection	V/F SVC FVC PMVF PMSVC PMFVC Master sending command selection. 0: Send run command; 1: Send running status	0 (0~1)

Group F12.2x: Special Modbus Functions

✧ F12.20: RJ45 Interface Communication Mode Selection

Parameter Code (Address)	Name	Description	Default (Range)
F12.20 (0x0C14) STOP	RJ45 interface communication mode selection	V/F SVC FVC PMVF PMSVC PMFVC	0 (0~3)

0: Dual-line keypad communication

1: Modbus RS485 communication (only for slave)

1: Modbus slave (Related parameters are set by F12.2x)

2: Modbus master (transmission parameters are set by F12.1x)

3: Defined by VEICHI

Note:

- When RJ45 interface is Modbus RS485 communication, the communication command setting and frequency setting channel will correspond to the option card.
- Models of T3 45 kW and above only support dual-line keypad communication

◇ **F12.21: Slave Address of RJ45 Interface**

Parameter Code (Address)	Name	Description	Default (Range)
F12.21 (0x0C15) STOP	Slave address of RJ45 interface	V/F SVC FVC PMVF PMSVC PMFVC Set the slave address when RJ45 interface is Modbus communication.	1 (1~247)

◇ **F12.22: RJ45 Interface Communication Baud Rate**

Parameter Code (Address)	Name	Description	Default (Range)
F12.22 (0x0C16) STOP	RJ45 interface communication baud rate selection	V/F SVC FVC PMVF PMSVC PMFVC Set the baud rate when RJ45 interface is Modbus communication.	3 (0~5)

- 0: 1200 bps
- 1: 2400 bps
- 2: 4800 bps
- 3: 9600 bps
- 4: 19200 bps
- 5: 38400 bps

Note: On the scene where the communication line interference is large, it will affect the successful communication rate, so the baud rate can be gradually reduced to improve the success rate.

◇ **F12.23: RJ45 Interface Data Format**

Parameter Code (Address)	Name	Description	Default (Range)
F12.23 (0x0C17) STOP	RJ45 interface data format	V/F SVC FVC PMVF PMSVC PMFVC Set the data format when RJ45 interface is Modbus communication.	0 (0~5)

This parameter set the data format for RJ45 interface communication. If the data formats are different, the communication may fail.

- 0: (N, 8, 1) No check, data bits: 8, stop bits: 1
- 1: (E, 8, 1) Even parity check, data bits: 8, stop bits: 1
- 2: (O, 8, 1) Odd parity check, data bits: 8, stop bits: 1
- 3: (N, 8, 2) No check, data bits: 8, stop bits: 2
- 4: (E, 8, 2) Even parity check, data bits: 8, stop bits: 2
- 5: (O, 8, 2) Odd parity check, data bits: 8, stop bits: 2

◇ F12.24: RJ45 Interface Transmission Response Processing

Parameter Code (Address)	Name	Description	Default (Range)
F12.24 (0x0C18) RUN	RJ45 interface transmission response processing	V/F SVC FVC PMVF PMSVC PMFVC Set the transmission response processing when RJ45 interface is Modbus communication.	0 (0~1)

This parameter selects whether the drive will respond to the write command from the host computer. If the host computer needs the drive to respond to the information, the drive will occupy the communication bus at different times. The host computer needs to save enough time to respond to the information when performing communication control. If the host computer does not need the drive to respond the information and only sends the command to the drive, select the write operation without response to improve the utilization efficiency of communication bus. This parameter is active for write operations only and has no effect on read operations.

0: Write with response

1: Write without response

◇ F12.25: RJ45 Interface Communication Response Delay

Parameter Code (Address)	Name	Description	Default (Range)
F12.25 (0x0C19) RUN	RJ45 interface communication response delay	V/F SVC FVC PMVF PMSVC PMFVC The response delay when RJ45 interface is Modbus communication.	0ms (0ms~500ms)

This parameter defines the interval between sending the response data to the host computer after receiving the data when the drive serve as the slave station of Modbus communication. If response delay is less than system processing time, the response delay is subject to the system processing time. If response delay is more than system processing time, the system need to wait the delay after processing the data, and will not send the data to host computer until the response delay time is up.

◇ F12.26: RJ45 Interface Communication Timeout Fault Time

Parameter Code (Address)	Name	Description	Default (Range)
F12.26 (0x0C1A) RUN	RJ45 interface communication timeout fault time	V/F SVC FVC PMVF PMSVC PMFVC The communication timeout when RJ45 interface is Modbus communication.	1.0s (0.1s~100.0s)

If the interval between one communication and the next communication exceeds the communication timeout time, it will be considered that the communication has disconnection fault, and determine the action against disconnection fault by [F12.27].

◇ F12.27: RJ45 Interface Communication disconnection Processing

Parameter Code (Address)	Name	Description	Default (Range)
F12.27 (0x0C1B) RUN	RJ45 Interface Communication disconnection Processing	V/F SVC FVC PMVF PMSVC PMFVC Sets the disconnection processing mode when RJ45 interface is for Modbus communication.	0 (0~3)

Communication disconnection processing mode selection

- 0: Do not detect timeout fault
- 1: Alarm and free stop
- 2: Warning and keep running
- 3: Forced stop

Note:

- Forced stop command is set. The motor is forced to stop by decelerate mode, and it will no longer respond to running command before stop.

Group F12.3x: PROFIBUS-DP Communication

✧ **F12.30: DP Card Address**

Parameter Code (Address)	Name	Description	Default (Range)
F12.30 (0x0C1E) RUN	DP card address	V/F SVC FVC PMVF PMSVC PMFVC Set the address for DP communication to set the slave.	1 (1~247)

Note: Do not hot plug the DP card.

✧ **F12.32: DP Communication disconnection Processing**

Parameter Code (Address)	Name	Description	Default (Range)
F12.32 (0x0C20) STOP	DP master-slave communication fault action	V/F SVC FVC PMVF PMSVC PMFVC Select the action for DP master-slave communication fault.	0 (0~2)

- 0: Do not detect timeout fault
- 1: Alarm and free stop
- 2: Warning and keep running

Group F12.4x: CAN Communication

✧ **F12.40: CAN Mode Selection**

Parameter Code (Address)	Name	Description	Default (Range)
F12.40 (0x0C28) RUN	CAN mode selection	V/F SVC FVC PMVF PMSVC PMFVC	0 (0~1)

Select the CAN communication mode when the drive performs CAN communication.

- 0: Slave station
- 1: Master station defined by VEICHI

Note: Do not hot plug the CAN card.

✧ **F12.41: CAN Communication Slave Address**

Parameter Code (Address)	Name	Description	Default (Range)
F12.41 (0x0C29)	CAN communication slave address	V/F SVC FVC PMVF PMSVC PMFVC	1 (1~247)

Note:

- When set the address, do not duplicate with other nodes, and set a value other than 0.

✧ **F12.42: CAN Communication Baud Rate Selection**

Parameter Code (Address)	Name	Description	Default (Range)
F12.42 (0x0C2A) RUN	CAN communication baud rate	V/F SVC FVC PMVF PMSVC PMFVC	3 (0~6)

CAN communication baud rate Sets the baud rate of CAN communication.

- 0: 20 kbps
- 1: 50 kbps
- 2: 100kbps
- 3: 125kbps
- 4: 250kbps
- 5: 500kbps
- 6: 1Mbps

✧ **F12.43: CAN Communication disconnection Processing**

Parameter Code (Address)	Name	Description	Default (Range)
F12.43 (0x0C2B) RUN	CAN Master-Slave Communication Fault Action	V/F SVC FVC PMVF PMSVC PMFVC CAN Master-Slave Communication Fault Action	0 (0~2)

- 0: Do not detect timeout fault
- 1: Alarm and free stop
- 2: Warning and keep running

Group F12.5x: Communication of Extension Ports EX-A and EX-B

✧ F12.50: Extension Port Communication disconnection Processing

Parameter Code (Address)	Name	Description	Default (Range)
F12.50 (0x0C32) RUN	Extension port communication disconnection processing	V/F SVC FVC PMVF PMSVC PMFVC	0000 (0000~0022)

LED"0": EX-A port disconnection action mode

- 0: Do not detect
- 1: Alarm and free stop
- 2: Warning and keep running

LED"00": EX-B port disconnection action mode

- 0: Do not detect
- 1: Alarm and free stop
- 2: Warning and keep running

Note: Do not hot plug the extension card connected to the extension ports.

✧ F12.51: Extension Port EX-A Parameter Updating

Parameter Code (Address)	Name	Description	Default (Range)
F12.51 (0x0C33) STOP	Extension port EX-A parameter updating	V/F SVC FVC PMVF PMSVC PMFVC	0 (0~2)

- 0: Do not update.
- 1: Update initial values on power-on.
- 2: The initial values are restored for extension port EX-A parameters

✧ F12.52: Extension Port EX-B Parameter Updating

Parameter Code (Address)	Name	Description	Default (Range)
F12.52 (0x0C34) STOP	Extension port EX-B parameter updating	V/F SVC FVC PMVF PMSVC PMFVC	0 (0~2)

- 0: Do not update.
- 1: Update initial values on power-on.
- 2: The initial values are restored for extension port EX-B parameters

◇ F12.53: Extension Port EX-A Monitor Frame Address Group 1

Parameter Code (Address)	Name	Description	Default (Range)
F12.53 (0x0C35) RUN	Extension port EX-A monitor frame address group 1	V/F SVC FVC PMVF PMSVC PMFVC	0001 (0000~0763)

◇ F12.54: Extension Port EX-A Monitor Frame Address Group 2

Parameter Code (Address)	Name	Description	Default (Range)
F12.54 (0x0C36) RUN	Extension port EX-A monitor frame address group 2	V/F SVC FVC PMVF PMSVC PMFVC	0002 (0000~0763)

◇ F12.55: Extension Port EX-A Monitor Frame Address Group 3

Parameter Code (Address)	Name	Description	Default (Range)
F12.55 (0x0C37) RUN	Extension port EX-A monitor frame address group 3	V/F SVC FVC PMVF PMSVC PMFVC	0007 (0000~0763)

◇ F12.56: Extension Port EX-A Monitor Frame Address Group 4

Parameter Code (Address)	Name	Description	Default (Range)
F12.56 (0x0C38) RUN	Extension port EX-A monitor frame address group 4	V/F SVC FVC PMVF PMSVC PMFVC	0011 (0000~0763)

LED'0' and LED'00': Lower 8 bits of address 00~63

LED'000' and LED'0000': Higher 8 bits of address 00~07

◇ F12.57: Extension Port EX-B Monitor Frame Address Group 1

Parameter Code (Address)	Name	Description	Default (Range)
F12.57 (0x0C39) RUN	Extension port EX-B monitor frame address group 1	V/F SVC FVC PMVF PMSVC PMFVC	0001 (0000~0763)

◇ F12.58: Extension Port EX-B Monitor Frame Address Group 2

Parameter Code (Address)	Name	Description	Default (Range)
F12.58 (0x0C3A)	Extension port EX-B monitor frame	V/F SVC FVC PMVF PMSVC PMFVC	0002 (0000~0763)

OFF	OFF	ON	Keypad potentiometer (optional outer single-line Keypad)
OFF	ON	OFF	Voltage/current AI1
OFF	ON	ON	Voltage/current AI2
ON	OFF	OFF	Reserved
ON	OFF	ON	Terminal pulse PUL
ON	ON	OFF	RS485 communication
ON	ON	ON	Option card

If you have any doubts about the above table, please refer to the F14 parameter group for the multi-speed sequence diagram of the multi-speed.

Note:

- Active current component can be sent by VEICHI CAN host. The RS485 communication address is 0x3011.

◇ **F13.01: Keypad Digital of PID Given/Feedback**

Parameter Code (Address)	Name	Description	Default (Range)
F13.01 (0x0D01) RUN	Keypad digital of PID given/feedback	V/F SVC FVC PMVF PMSVC PMFVC Set the PID given/feedback values set by keypad digital.	50.0% (0.0%~100.0%)

This parameter is active only if [F13.00]/[F13.03] is set to the PID given/feedback of keypad digital. After this parameter is changed, the PID set point for the monitoring object will be automatically modified synchronously.

When the LED"0" of parameter [F11.04] is set to 2, the value of the parameter can be promptly modified by the up and down keys of the keypad. After modifying it, whether the drive saves the modified value during power off is determined by the set point in the LED"00" of the [F11.04].

◇ **F13.02: PID Setting Change Time**

Parameter Code (Address)	Name	Description	Default (Range)
F13.02 (0x0D02) RUN	PID setting change time	V/F SVC FVC PMVF PMSVC PMFVC Set PID setting change time.	1.00s (0.00s~60.00s)

PID setting change time:

This refers to the time required for the PID setting percentage to change from 0.0% to 100.0%. When the set PID changes, the PID set point changes linearly in accordance with the set change time to reduce the adverse impact of the set mutation on the system.

◇ **F13.03: PID Control Feedback Source**

Parameter Code (Address)	Name	Description	Default (Range)
F13.03 (0x0D03) RUN	PID control feedback source	V/F SVC FVC PMVF PMSVC PMFVC Set the feedback signal source of PID control.	2 (0~9)

Sets the input channel for the tension PID controller feedback signal.

0: Keypad digital PID feedback The PID feedback channel is determined by the set point of [F13.01].

1: Keypad potentiometer(optional external single-line Keypad).

2: Voltage/current AI1 feedback The PID feedback channel is analog AI1.

3: Voltage/current AI2 feedback The PID feedback channel is analog AI2.

4: Reserved

5: terminal pulse PUL feedback The PID feedback channel is terminal pulse PUL.

6: RS485 communication feedback The PID feedback channel is RS485 communication.

7: Option card The PID feedback channel is option card, refer to the instructions of the option card.

8: Terminal selection The PID feedback channel is selected by the combination of multi-functional input terminals, which are set by [F05.00~F05.09].

9: Local active current

Terminal switching selection diagram:

Terminal 3	Terminal 2	Terminal 1	Selection of Terminal for PID Setting
OFF	OFF	OFF	PID feedback with keypad digital
OFF	OFF	ON	Keypad potentiometer (optional outer single-line Keypad).
OFF	ON	OFF	Current/voltage analog AI1
OFF	ON	ON	Current/voltage analog AI2
ON	OFF	OFF	Reserved.
ON	OFF	ON	Terminal pulse PUL feedback
ON	ON	OFF	Feedback via RS485 communication
ON	ON	ON	Option card.

If you have any doubts about the above table, please refer to the F14 parameter group for the multi-speed sequence diagram of the multi-speed.

Note:

- **The set signal source of PID controller and the feedback signal source of PID controller cannot be set to the same channel, otherwise, PID cannot work normally.**

✧ **F13.04: Feedback Signal Low-Pass Filter Time**

Parameter Code (Address)	Name	Description	Default (Range)
F13.04 (0x0D04) RUN	Feedback signal low-pass filter time	V/F SVC FVC PMVF PMSVC PMFVC Set the feedback signal low-pass filter time.	0.010s (0.000s~6.000s)

Feedback signal filter time: It is used to filter the feedback signal, which can reduce the interference influence on the feedback quantity. The longer the filter time, the stronger the anti-interference capability, but the slower the reaction speed.

✧ **F13.05: Feedback Signal Gain**

Parameter Code (Address)	Name	Description	Default (Range)
F13.05 (0x0D05) RUN	Feedback signal gain	V/F SVC FVC PMVF PMSVC PMFVC Set the feedback signal gain.	1.00 (0.00~10.00)

Feedback Signal Gain: For linear proportional adjustment of feedback input signal

✧ **F13.06: Feedback Signal Range**

Parameter Code (Address)	Name	Description	Default (Range)
F13.06 (0x0D06) RUN	Feedback signal range	V/F SVC FVC PMVF PMSVC PMFVC Set the feedback signal range.	100.0 (0.0~100.0)

Feedback signal range: PID feedback signal range is a dimensionless unit, used to adjust PID feedback display.

F13.07 - F13.24: PID Adjustment✧ **F13.07: PID Control Selection**

Parameter Code (Address)	Name	Description	Default (Range)
F13.07 (0x0D07) RUN	PID control selection	V/F SVC FVC PMVF PMSVC PMFVC	0100 (0000~1111)

LED"0": Feedback characteristic selection

0: Positive characteristic. Which applies to the scenario where the PID feedback quantity is greater than the PID set quantity, the frequency of the frequency drive output is required to decline to maintain the PID balance, such as constant pressure water supply, air supply, winding tension control, etc.

1: Negative characteristic. Which applies to the scenario where the PID feedback quantity is greater than the PID set quantity, the frequency of the frequency drive output is required to rise to maintain the PID balance, such as central air conditioning constant temperature control, tension control of unwinding, etc.

LED"00": Reserved

LED"000": Reserved

LED"0000": Differential adjustment attribute

0: Differentiate deviation

1: Differentiate feedback

◇ F13.08: PID Preset Output

Parameter Code (Address)	Name	Description	Default (Range)
F13.08 (0x0D08) RUN	PID preset output	V/F SVC FVC PMVF PMSVC PMFVC Set the PID preset output.	100.0% (0.0%~100.0%)

◇ F13.09: PID Preset Output Running Time

Parameter Code (Address)	Name	Description	Default (Range)
F13.09 (0x0D09) RUN	PID preset output running time	V/F SVC FVC PMVF PMSVC PMFVC Used to set the PID preset output running time.	0.0s (0.0s~6500.0s)

When this function is defined as PID running startup, the output is first conducted according to PID preset output [F13.08], and the output value will run continuously for the time set in PID preset output running time [F13.09] before running according to the PID closed-loop characteristics.

Note: when PID is used for frequency setting, [F01.02=8] preset output at 100% corresponds to the maximum frequency output.

◇ F13.10: PID Control Deviation Limit

Parameter Code (Address)	Name	Description	Default (Range)
F13.10 (0x0D0A) RUN	PID control deviation limit	V/F SVC FVC PMVF PMSVC PMFVC Used to set the PID control deviation limit.	0.0% (0.0%~100.0%)

The maximum allowable deviation of PID feedback value relative to the PID set value. When the feedback value is within this range, PID regulation stops and the output remains unchanged. Appropriate use of this function is helpful to minimize the conflict between the accuracy and stability of system output.

◇ F13.11: Proportional Gain P1

Parameter Code (Address)	Name	Description	Default (Range)
F13.11 (0x0D0B) RUN	Proportional Gain P1	V/F SVC FVC PMVF PMSVC PMFVC Determines the regulation intensity of the PID regulator. The higher the gain, the greater the regulation intensity. However, excessively high intensity may easily result in oscillation.	0.100 (0.000~4.000)

◇ F13.12: Integral Time I1

Parameter Code (Address)	Name	Description	Default (Range)
F13.12 (0x0D0C) RUN	Integral time I1	V/F SVC FVC PMVF PMSVC PMFVC Determines the integral regulation intensity of the PID regulator. The shorter the integral time, the greater the regulation intensity. The PID integral action will be Invalid when the integral time is set to 0.	1.0s (0.0s~600.0s)

◇ F13.13: Differential Gain D1

Parameter Code (Address)	Name	Description	Default (Range)
F13.13 (0x0D0D) RUN	Differentiation gain D1	V/F SVC FVC PMVF PMSVC PMFVC Determines the intensity of the PID regulator to adjust the deviation or rate of change of the feedback signal. Differential adjustment attribute is selected through the [F13.07] kilobit. The longer the differential time, the greater the regulation intensity.	0.000s (0.000~6.000)

◇ F13.14: Proportional Gain P2

Parameter Code (Address)	Name	Description	Default (Range)
F13.14 (0x0D0E) RUN	Proportional gain P2	V/F SVC FVC PMVF PMSVC PMFVC Determines the regulation intensity of the PID regulator. The higher the gain, the greater the regulation intensity. However, excessively high intensity may easily result in oscillation.	0.100 (0.000~4.000)

◇ F13.15: Integral Time I2

Parameter Code (Address)	Name	Description	Default (Range)
F13.15 (0x0D0F) RUN	Integral time I2	V/F SVC FVC PMVF PMSVC PMFVC Set the integral time. When set as 0, the PID integral action is invalid.	1.0s (0.0s~600.0s)

◇ F13.16: Differential Gain D2

Parameter Code (Address)	Name	Description	Default (Range)
F13.16 (0x0D10) RUN	Differentiation gain D2	V/F SVC FVC PMVF PMSVC PMFVC Determines the intensity of the PID regulator to adjust the deviation or rate of change of the feedback signal. Differential adjustment attribute is selected through the [F13.07] kilobit. The longer the differential time, the greater the regulation intensity.	0.000s (0.000~6.000)

The adjustment parameters of the PID controller. The parameter values should be adjusted according to actual system characteristics. PID parameter group 1 (F13.11~F13.13) and PID parameter group 2 (F13.14~F13.16), which are used for condition selection during changeover between two groups of PID parameters through the [F13.17] function code.

Proportional gain:

Determines the regulation intensity of the PID regulator. The higher the gain, the greater the regulation intensity. However, excessively high intensity may easily result in oscillation.

Integral time:

Determines the integral regulation intensity of the PID regulator. The shorter the integral time, the greater the regulation intensity. The PID regulation will be Invalid when the integral time is 0.

Differential time:

Determines the intensity of the PID regulator to adjust the deviation or rate of change of the feedback signal. Differential adjustment attribute is selected through the [F13.07] kilobit. The longer the differential time, the greater the regulation intensity. The function of differential adjustment is to suppress the change of feedback signal by making adjustments based on the trend of its change.

◇ **F13.17: PID Parameter Switching Conditions**

Parameter Code (Address)	Name	Description	Default (Range)
F13.17 (0x0D11) RUN	PID parameter switching conditions	V/I SVC FVC PMVF PMSVC PMFVC Used to set the PID parameter changeover condition.	0 (0~2)

In some applications, one group of PID adjustment parameters can not meet requirements of the entire process, and different PID parameter groups must be adopted.

PID parameter changeover conditions:

0: No changeover Select PID parameter group 1 for PID parameters.

1: Changeover by using the Xi terminal 23 must be set (PID parameter changeover) for multi-functional terminal function selection. When the terminal is invalid, select PID parameter group 1; when the terminal is valid, select PID parameter group 2.

2: Changeover according to deviation When the absolute value of deviation between the PID setting and the feedback is less than [F13.18], select parameter group 1 for PID parameters; when the absolute value of deviation between the PID setting and the feedback is more than [F13.19], select parameter group 2 for PID parameters; when the absolute value of deviation between the PID setting and the feedback is between the lower value of changeover deviation [F13.18] and the higher value of changeover deviation [F13.19], the PID parameter will be the linear interpolation value of the two groups of PID parameters.

which is shown as follows:

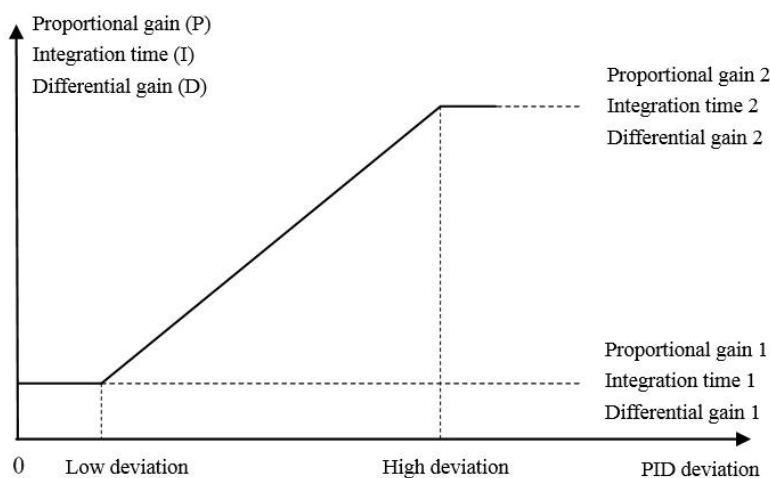

Diagram of deviation-based PID parameter changeover

◇ **F13.18: Lower Value of Switching Deviation**

Parameter	Name	Description	Default
-----------	------	-------------	---------

Code (Address)	Name	Description	(Range)
F13.18 (0x0D12) RUN	Lower value of switching deviation	V/F SVC FVC PMVF PMSVC PMFVC	20.0% (0.0%~100.0%)

◇ F13.19: Higher Value of Changeover Deviation

Parameter Code (Address)	Name	Description	Default (Range)
F13.19 (0x0D13) RUN	Higher value of switching deviation	V/F SVC FVC PMVF PMSVC PMFVC	80.0% (0.0%~100.0%)

◇ F13.20: Reserved

◇ F13.21: Differentiation Limit

Parameter Code (Address)	Name	Description	Default (Range)
F13.21 (0x0D15) RUN	Differentiation limit	V/F SVC FVC PMVF PMSVC PMFVC	5.0% (0.0%~100.0%)

The differential limit is used to set the range of the PID differential output. In a PID regulator, the function of differentiation is sensitive, as it is likely to cause system oscillation. Generally, the function of PID differentiation is limited to a small range.

◇ F13.22: PID Output Upper Limit

Parameter Code (Address)	Name	Description	Default (Range)
F13.22 (0x0D16) RUN	PID output upper limit	V/F SVC FVC PMVF PMSVC PMFVC Used to set the PID output upper limit value.	100.0% (0.0%~100.0%)

◇ F13.23: PID Output Lower Limit

Parameter Code (Address)	Name	Description	Default (Range)
F13.23 (0x0D17) RUN	PID output lower limit	V/F SVC FVC PMVF PMSVC PMFVC Used to set the PID output lower limit value.	0.0% (-100.0~F13.22)

◇ F13.24: PID output filter time

Parameter Code (Address)	Name	Description	Default (Range)
F13.24 (0x0D18) RUN	PID output filter time	V/F SVC FVC PMVF PMSVC PMFVC Used to set the PID output filter time.	0.000s (0.000s~6.000s)

The PID output filter time is used to filter the PID output. The filter will weaken the sudden changes of the PID regulation output result and degrade the response performance of the process closed-loop system.

F13.25~F13.28: PID Feedback Disconnection Judgment

The feedback disconnection detection function works in the following way: The sensor is considered to have a broken wire when the detected feedback signal is greater than the set point of [F13.27] or smaller than the set point of [F13.28] and the duration exceeds the delay time in [F13.26] while the frequency drive is running and PID setting is selected as the frequency drive setting method.

✧ F13.25: Feedback disconnection Action Selection

Parameter Code (Address)	Name	Description	Default (Range)
F13.25 (0x0D19) RUN	Feedback disconnection action selection	V/F SVC FVC PMVF PMSVC PMFVC	0 (0~3)

Feedback disconnection action selection:

0: Continue PID running without alarm This function is invalid and the frequency drive does not perform disconnection detection.

1: Stop and alarm E. PiD The frequency drive blocks output immediately when detecting sensor disconnection, and the motor free stop and triggers the alarm E. PiD.

2: Continue PID running and output fault warning A. PiD The frequency drive continues running based on the PID adjustment when detecting sensor disconnection, but the keypad displays the alarm A. PiD.

3: Run at current frequency and warning A. PiD The frequency drive maintains the output frequency before the fault when detecting sensor disconnection, but the keypad displays the alarm A. PiD.

✧ F13.26: Feedback disconnection Detection Time

Parameter Code (Address)	Name	Description	Default (Range)
F13.26 (0x0D1A) RUN	Feedback disconnection detection time	V/F SVC FVC PMVF PMSVC PMFVC Used to set the PID feedback disconnection detection time.	1.0s (0.0s~120.0s)

✧ F13.27: Disconnection Alarm Upper Limit

Parameter Code (Address)	Name	Description	Default (Range)
F13.27 (0x0D1B) RUN	Disconnection alarm upper limit	V/F SVC FVC PMVF PMSVC PMFVC Used to set the PID disconnection alarm upper limit .	100.0% (0.0%~100.0%)

✧ F13.28: Disconnection Alarm Lower Limit

Parameter Code (Address)	Name	Description	Default (Range)
F13.28 (0x0D1C) RUN	Disconnection alarm lower limit	V/F SVC FVC PMVF PMSVC PMFVC Used to set the PID disconnection alarm lower limit .	0.0% (0.0%~100.0%)

Disconnection alarm upper limit:

Set the upper limit of PID sensor disconnection detection. The sensor is considered to have a broken wire when the feedback signal has been larger than the upper limit of disconnection alarm for the delay time in [F13.26].

Disconnection alarm lower limit:

Set the lower limit of PID sensor disconnection detection. The sensor is considered to have a broken wire when the feedback signal has been smaller than the upper limit of disconnection alarm for the delay time in [F13.26].

F13.29 - F13.33: Sleep Function

The PID sleep function can be used in water supply industries with constant pressure to achieve the purpose of energy saving.

Sleep determination:

When the sleep function is valid and the PID adjustment output frequency is lower than the sleep frequency set in [F13.30], sleep mode will be entered after the [F13.31] sleep delay (i.e. blocking output when decelerating to zero frequency).

Note: The sleep entry prerequisite: does not trigger before the PID feedback becomes greater than the PID setting at positive characteristics; does not trigger before the PID feedback becomes less than the PID setting at negative characteristics.

Wake-up determination:

When PID feedback characteristics are positive characteristics: compare the value of PID setting minus wake-up deviation [F13.32] with PID feedback. The sleep mode is exited and the normal operating state is entered after the wake-up delay [F13.33] if the former is continuously greater than the latter.

When PID feedback characteristics are negative characteristics: compare the value of PID setting plus wake-up deviation [F13.32] with PID feedback. The sleep mode is exited and the normal operating state is entered after the wake-up delay [F13.33] if the former is continuously less than the latter.

◇ F13.29: Sleep Selection

Parameter Code (Address)	Name	Description	Default (Range)
F13.29 (0x0D1D) RUN	Sleep selection	V/F SVC FVC PMVF PMSVC PMFVC 0: Invalid Do not perform sleep detection 1: Valid Perform sleep detection	0 (0~1)

◇ F13.30: Sleep Frequency

Parameter Code (Address)	Name	Description	Default (Range)
F13.30 (0x0D1E) RUN	Sleep frequency	V/F SVC FVC PMVF PMSVC PMFVC Used to set the PID sleep frequency.	10.0Hz (0.00Hz~F01.10)

◇ F13.31: Sleep Delay Time

Parameter Code (Address)	Name	Description	Default (Range)
F13.31 (0x0D1F) RUN	Sleep delay time	V/F SVC FVC PMVF PMSVC PMFVC Used to set the PID sleep delay time.	60.0s (0.0s~3600.0s)

◇ F13.32: Wake-up Deviation

Parameter Code (Address)	Name	Description	Default (Range)
F13.32 (0x0D20) RUN	Wake-up deviation	V/F SVC FVC PMVF PMSVC PMFVC Used to set the PID wake-up deviation.	5.0% (0.0%~50.0%)

✧ **F13.33: Wake-up Delay Time**

Parameter Code (Address)	Name	Description	Default (Range)
F13.33 (0x0D21) RUN	Wake-up delay time	V/F SVC FVC PMVF PMSVC PMFVC Used to set the PID wake-up delay time.	1.0s (0.0s~60.0s)

11.16 Group F14: Multi-Speed and Simple PLC

F14.00 - F14.14: Multi-Speed Frequency Setting

This group of parameters is used to set the running frequency of 15 speed stages in PLC program operation and multi-speed control.

Multi-speed control has the priority just lower than jog control. When multi-speed operation is selected, you must set 4 multi-functional input terminals as multi-speed control terminals. See detailed descriptions in [F05.00~F05.09] for specific setting methods.

✧ **F14.00: PLC Multi-Speed 1**

Parameter Code (Address)	Name	Description	Default (Range)
F14.00 (0x0E00) RUN	PLC Multi-Speed 1	V/F SVC FVC PMVF PMSVC PMFVC Set the frequency of the 1st stage in PLC program operation and multi-speed control.	10.00 Hz (0.00 Hz - maximum frequency)

✧ **F14.01: PLC Multi-Speed 2**

Parameter Code (Address)	Name	Description	Default (Range)
F14.01 (0x0E01) RUN	PLC Multi-Speed 2	V/F SVC FVC PMVF PMSVC PMFVC Set the frequency of the 2nd stage in PLC program operation and multi-speed control.	20.00 Hz (0.00 Hz - maximum frequency)

✧ **F14.02: PLC Multi-Speed 3**

Parameter Code (Address)	Name	Description	Default (Range)
F14.02 (0x0E02) RUN	PLC Multi-Speed 3	V/F SVC FVC PMVF PMSVC PMFVC Set the frequency of the 3rd stage in PLC program operation and multi-speed control.	30.00 Hz (0.00 Hz - maximum frequency)

◇ F14.03: PLC Multi-Speed 4

Parameter Code (Address)	Name	Description	Default (Range)
F14.03 (0x0E03) RUN	PLC Multi-Speed 4	V/F SVC FVC PMVF PMSVC PMFVC Set the frequency of the 4th stage in PLC program operation and multi-speed control.	40.00 Hz (0.00 Hz - maximum frequency)

◇ F14.04: PLC Multi-Speed 5

Parameter Code (Address)	Name	Description	Default (Range)
F14.04 (0x0E04) RUN	PLC Multi-Speed 5	V/F SVC FVC PMVF PMSVC PMFVC Set the frequency of the 5th stage in PLC program operation and multi-speed control.	50.00 Hz (0.00 Hz - maximum frequency)

◇ F14.05: PLC Multi-Speed 6

Parameter Code (Address)	Name	Description	Default (Range)
F14.05 (0x0E05) RUN	PLC Multi-Speed 6	V/F SVC FVC PMVF PMSVC PMFVC Set the frequency of the 6th stage in PLC program operation and multi-speed control.	40.00 Hz (0.00 Hz - maximum frequency)

◇ F14.06: PLC Multi-Speed 7

Parameter Code (Address)	Name	Description	Default (Range)
F14.06 (0x0E06) RUN	PLC Multi-Speed 7	V/F SVC FVC PMVF PMSVC PMFVC Set the frequency of the 7th stage in PLC program operation and multi-speed control.	30.00 Hz (0.00 Hz - maximum frequency)

◇ F14.07: PLC Multi-Speed 8

Parameter Code (Address)	Name	Description	Default (Range)
F14.07 (0x0E07) RUN	PLC Multi-Speed 8	V/F SVC FVC PMVF PMSVC PMFVC Set the frequency of the 8th stage in PLC program operation and multi-speed control.	20.00 Hz (0.00 Hz - maximum frequency)

◇ F14.08: PLC Multi-Speed 9

Parameter Code (Address)	Name	Description	Default (Range)
F14.08 (0x0E08) RUN	PLC Multi-Speed 9	V/F SVC FVC PMVF PMSVC PMFVC Set the frequency of the 9th stage in PLC program operation and multi-speed control.	10.00 Hz (0.00 Hz - maximum frequency)

◇ F14.09: PLC Multi-Speed 10

Parameter Code (Address)	Name	Description	Default (Range)

F14.09 (0x0E09) RUN	PLC Multi-Speed 10	V/F SVC FVC PMVF PMSVC PMFVC Set the frequency of the 10th stage in PLC program operation and multi-speed control.	20.00 Hz (0.00 Hz - maximum frequency)
---------------------------	-----------------------	--	---

✧ F14.10: PLC Multi-Speed 11

Parameter Code (Address)	Name	Description	Default (Range)
F14.10 (0x0E0A) RUN	PLC Multi-Speed 11	V/F SVC FVC PMVF PMSVC PMFVC Set the frequency of the 11th stage in PLC program operation and multi-speed control.	30.00 Hz (0.00 Hz - maximum frequency)

✧ F14.10: PLC Multi-Speed 12

Parameter Code (Address)	Name	Description	Default (Range)
F14.11 (0xE0B) RUN	PLC Multi-Speed 12	V/F SVC FVC PMVF PMSVC PMFVC Set the frequency of the 12th stage in PLC program operation and multi-speed control.	40.00 Hz (0.00 Hz - maximum frequency)

✧ F14.12: PLC Multi-Speed 13

Parameter Code (Address)	Name	Description	Default (Range)
F14.12 (0x0E0C) RUN	PLC Multi-Speed 13	V/F SVC FVC PMVF PMSVC PMFVC Set the frequency of the 13th stage in PLC program operation and multi-speed control.	50.00 Hz (0.00 Hz - maximum frequency)

✧ F14.13: PLC Multi-Speed 14

Parameter Code (Address)	Name	Description	Default (Range)
F14.13 (0x0E0D) RUN	PLC Multi-Speed 14	V/F SVC FVC PMVF PMSVC PMFVC Set the frequency of the 14th stage in PLC program operation and multi-speed control.	40.00 Hz (0.00 Hz - maximum frequency)

✧ F14.14: PLC Multi-Speed 15

Parameter Code (Address)	Name	Description	Default (Range)
F14.14 (0x0E0E) RUN	PLC Multi-Speed 15	V/F SVC FVC PMVF PMSVC PMFVC Set the frequency of the 15th stage in PLC program operation and multi-speed control.	30.00 Hz (0.00 Hz - maximum frequency)

These 4 multi-speed control terminals are combined with ON/OFF of COM to control in which speed stage the frequency drive is running. Its operation and direction are controlled by the motion signal and direction given by the command channel [F01.01]. Its acceleration and deceleration time is set as the acceleration and deceleration time 1 [F01.22] and [F01.23] by default. The acceleration and deceleration time can also be selected by choosing terminals based on the acceleration and deceleration time set through multi-functional input terminals [F05.00~F05.09].

Multi-Speed Terminal 4	Multi-Speed Terminal 3	Multi-Speed Terminal 2	Multi-Speed Terminal 1	Terminal
				Stage speed
OFF	OFF	OFF	ON	1X [F14.00]
OFF	OFF	ON	OFF	2X [F14.01]

OFF	OFF	ON	ON	3X [F14.02]
OFF	ON	OFF	OFF	4X [F14.03]
OFF	ON	OFF	ON	5X [F14.04]
OFF	ON	ON	OFF	6X [F14.05]
OFF	ON	ON	ON	7X [F14.06]
ON	OFF	OFF	OFF	8X [F14.07]
ON	OFF	OFF	ON	9X [F14.08]
ON	OFF	ON	OFF	10X [F14.09]
ON	OFF	ON	ON	11X [F14.10]
ON	ON	OFF	OFF	12X [F14.11]
ON	ON	OFF	ON	13X [F14.12]
ON	ON	ON	OFF	14X [F14.13]
ON	ON	ON	ON	15X [F14.14]

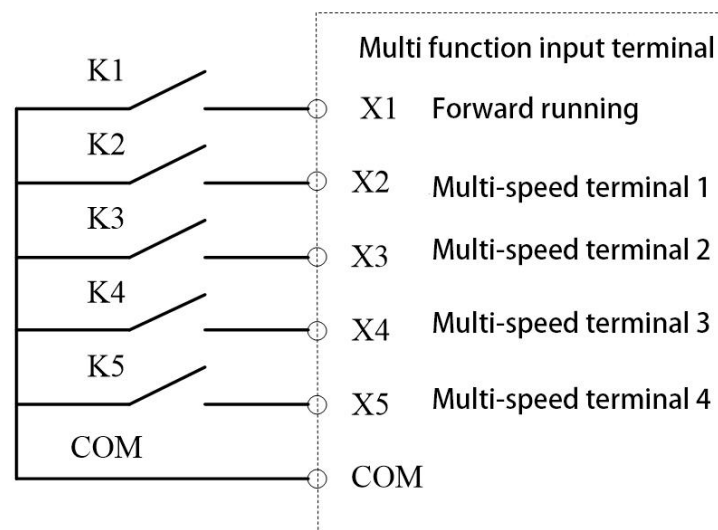

Terminal connection diagram

F14.15: PLC Running Mode Selection

◇ F14.15: PLC Running Mode Selection

Parameter Code (Address)	Name	Description	Default (Range)
F14.15 (0x0E0F) RUN	PLC running mode selection	V/F SVC FVC PMVF PMSVC PMFVC	0000 (0000~2122)

LED"0": Cycling method Used to select the PLC operation mode given by program control.

0: Stop after a single cycle After accepting an operation instruction, the frequency drive starts running from the first stage speed, where the unit of time is set by the LED LED"00" in [F14.15]; the running time is set by parameters [F14.16~F14.30]; the running direction and acceleration and deceleration time are selected via parameters [F14.31~F14.45]; the frequency drive will run at the next stage speed when the running time expires. The time, direction, and acceleration and deceleration time of operation of each stage speed can be set separately. The frequency drive outputs "0" frequency after running at the 15th stage speed. If the running time of a certain stage is zero, that stage is skipped during operation.

1: Continuous cycle After running at the 15th stage speed, the frequency drive returns to the 1st stage speed and restarts operation, without stopping the cycle. The unit of time is set by the LED LED"00" in [F14.15]; the running time is set by parameters [F14.16~F14.30]; the running direction and acceleration and deceleration time are selected via parameters [F14.31~F14.45].

2: Maintain the final value after a single cycle The frequency drive will run continuously at the last stage speed where the running time is not zero without stop after running a single cycle. The unit of time is set by the LED LED"00" in [F14.15]; the running time is set by parameters [F14.16~F14.30]; the running direction and acceleration and deceleration time are selected via parameters [F14.31~F14.45].

LED"00": Timing unit Used to set the time unit for timing during program operation

0: Second (s)

1: Minute (m)

2: Hour (h)

LED"000": Power-off storage mode

0: Do not store

1: Store

This parameter is defined as whether the frequency drive stores current program operation status (running stage, remaining time of this stage, acceleration and deceleration, and running direction, etc.) upon power-off when program operation is selected. If power-off storage is selected, the program operation restoration method following the next power-on can be defined in cooperation with the LED LED"0000" parameter in [F14.15]. You should set this parameter as "1" in order to ensure that the frequency drive can resume its condition after an instantaneous power-off.

LED"0000": Start method

0: Re-run from stage one

1: Re- run from the stage of stop

2: Re-run from the remaining time of the stage upon stop last time

This parameter defines the operation mode during restart following interruption of the program operation process due to various reasons (stop, failure, blackout, etc.).

When "0" mode is selected, the frequency drive will restart at the first stage speed.

When "1" mode is selected, the frequency drive will time and run again using the running stage at the moment of interruption.

When "2" mode is selected, the frequency drive will run with the running stage at the moment of interruption and according to the remaining time of that stage at the moment of interruption.

Note:

- The output frequency during program operation is restricted by the upper and lower frequency limits. When the set frequency is lower than the lower frequency limit, operation will start running at the lower limit frequency in [F01.13].

F14.16 - F14.30: PLC Running Time Selection

Used to set running times of 15 stage speeds respectively. The unit of time is determined by the set point of the LED"00" in [F14.15].

◇ F14.16: PLC 1st Stage Running Time

Parameter Code (Address)	Name	Description	Default (Range)
F14.16 (0x0E10) RUN	PLC segment 1 running time	V/F SVC FVC PMVF PMSVC PMFVC Set the running time for the 1st segment of PLC program.	10.0(s/m/h) (0.0(s/m/h)~ 6500.0(s/m/h))

◇ F14.17: PLC 2nd Stage Running Time

Parameter Code (Address)	Name	Description	Default (Range)
F14.17 (0x0E11) RUN	PLC segment 2 running time	V/F SVC FVC PMVF PMSVC PMFVC Set the running time for the 2nd segment of PLC program.	10.0(s/m/h) (0.0(s/m/h)~ 6500.0(s/m/h))

◇ F14.18: PLC 3rd Stage Running Time

Parameter Code (Address)	Name	Description	Default (Range)
F14.18 (0x0E12) RUN	PLC segment 3 running time	V/F SVC FVC PMVF PMSVC PMFVC Set the running time for the 3rd segment of PLC program.	10.0(s/m/h) (0.0(s/m/h)~ 6500.0(s/m/h))

◇ F14.19: PLC 4th Stage Running Time

Parameter Code (Address)	Name	Description	Default (Range)
F14.19 (0x0E13) RUN	PLC segment 4 running time	V/F SVC FVC PMVF PMSVC PMFVC Set the running time for the 4th segment of PLC program.	10.0(s/m/h) (0.0(s/m/h)~ 6500.0(s/m/h))

◇ F14.20: PLC 5th Stage Running Time

Parameter Code (Address)	Name	Description	Default (Range)
F14.20 (0x0E14) RUN	PLC segment 5 running time	V/F SVC FVC PMVF PMSVC PMFVC Set the running time for the 5th segment of PLC program.	10.0(s/m/h) (0.0(s/m/h)~ 6500.0(s/m/h))

◇ F14.21: PLC 6th Stage Running Time

Parameter Code (Address)	Name	Description	Default (Range)
F14.21 (0x0E15) RUN	PLC segment 6 running time	V/F SVC FVC PMVF PMSVC PMFVC Set the running time for the 6th segment of PLC program.	10.0(s/m/h) (0.0(s/m/h)~ 6500.0(s/m/h))

◇ F14.22: PLC 7th Stage Running Time

Parameter Code (Address)	Name	Description	Default (Range)
F14.22 (0x0E16) RUN	PLC segment 7 running time	V/F SVC FVC PMVF PMSVC PMFVC Set the running time for the 7th segment of PLC program.	10.0(s/m/h) (0.0(s/m/h)~ 6500.0(s/m/h))

◇ F14.23: PLC 8th Stage Running Time

Parameter Code (Address)	Name	Description	Default (Range)
F14.23 (0x0E17) RUN	PLC segment 8 running time	V/F SVC FVC PMVF PMSVC PMFVC Set the running time for the 8th segment of PLC program.	10.0(s/m/h) (0.0(s/m/h)~ 6500.0(s/m/h))

◇ F14.24: PLC 9th Stage Running Time

Parameter Code (Address)	Name	Description	Default (Range)
F14.24 (0x0E18) RUN	PLC segment 9 running time	V/F SVC FVC PMVF PMSVC PMFVC Set the running time for the 9th segment of PLC program.	10.0(s/m/h) (0.0(s/m/h)~ 6500.0(s/m/h))

◇ F14.25: PLC 10th Stage Running Time

Parameter Code (Address)	Name	Description	Default (Range)
F14.25 (0x0E19) RUN	PLC segment 10 running time	V/F SVC FVC PMVF PMSVC PMFVC Set the running time for the 10th segment of PLC program.	10.0(s/m/h) (0.0(s/m/h)~ 6500.0(s/m/h))

◇ F14.26: PLC 11th Stage Running Time

Parameter Code (Address)	Name	Description	Default (Range)
F14.26 (0x0E1A) RUN	PLC segment 11 running time	V/F SVC FVC PMVF PMSVC PMFVC Set the running time for the 11th segment of PLC program.	10.0(s/m/h) (0.0(s/m/h)~ 6500.0(s/m/h))

◇ F14.27: PLC 12th Stage Running Time

Parameter Code (Address)	Name	Description	Default (Range)
F14.27 (0x0E1B) RUN	PLC segment 12 running time	V/F SVC FVC PMVF PMSVC PMFVC Set the running time for the 12th segment of PLC program.	10.0(s/m/h) (0.0(s/m/h)~ 6500.0(s/m/h))

◇ F14.28: PLC 13th Stage Running Time

Parameter Code (Address)	Name	Description	Default (Range)
F14.28 (0x0E1C) RUN	PLC segment 13 running time	V/F SVC FVC PMVF PMSVC PMFVC Set the running time for the 13th segment of PLC program.	10.0(s/m/h) (0.0(s/m/h)~ 6500.0(s/m/h))

◇ F14.29: PLC 14th Stage Running Time

Parameter Code (Address)	Name	Description	Default (Range)
F14.29 (0x0E1D) RUN	PLC segment 14 running time	V/F SVC FVC PMVF PMSVC PMFVC Set the running time for the 14th segment of PLC program.	10.0s (0.0(s/m/h)~ 6500.0(s/m/h))

◇ F14.30: PLC 15th Stage Running Time

Parameter Code (Address)	Name	Description	Default (Range)
F14.30 (0x0E1E) RUN	PLC segment 15 running time	V/F SVC FVC PMVF PMSVC PMFVC Set the running time for the 15th segment of PLC program.	10.0(s/m/h) (0.0(s/m/h)~ 6500.0(s/m/h))

F14.31~F14.45: PLC Direction and Acceleration/Deceleration Time Selection

Used to set running directions and acceleration and deceleration times of 15 stage speeds respectively during program operation.

◇ F14.31: PLC 1st Stage Direction And Acceleration And Deceleration Time

Parameter Code (Address)	Name	Description	Default (Range)
F14.31 (0x0E1F) RUN	Direction and Acceleration/Deceleration Time of PLC Segment 1	V/F SVC FVC PMVF PMSVC PMFVC Used to set the running direction and acceleration and deceleration time of 1st stage.	0000 (0000~0031)

◇ F14.32: PLC 2nd Stage Direction And Acceleration And Deceleration Time

Parameter Code (Address)	Name	Description	Default (Range)
F14.32 (0x0E20) RUN	Direction and Acceleration/Deceleration Time of PLC Segment 2	V/F SVC FVC PMVF PMSVC PMFVC Used to set the running direction and acceleration and deceleration time of 2nd stage.	0000 (0000~0031)

◇ F14.33: PLC 3rd Stage Direction And Acceleration And Deceleration Time

Parameter Code (Address)	Name	Description	Default (Range)
F14.33 (0x0E21) RUN	Direction and Acceleration/Deceleration Time of PLC Segment 3	V/F SVC FVC PMVF PMSVC PMFVC Used to set the running direction and acceleration and deceleration time of 3rd stage.	0000 (0000~0031)

◇ F14.34: PLC 4th Stage Direction And Acceleration And Deceleration Time

Parameter Code (Address)	Name	Description	Default (Range)
F14.34 (0x0E22) RUN	Direction and Acceleration/Deceleration Time of PLC Segment 4	V/F SVC FVC PMVF PMSVC PMFVC Used to set the running direction and acceleration and deceleration time of 4th stage.	0000 (0000~0031)

◇ F14.35: PLC 5th Stage Direction And Acceleration And Deceleration Time

Parameter Code (Address)	Name	Description	Default (Range)
F14.35 (0x0E23) RUN	Direction and Acceleration/Deceleration Time of PLC Segment 5	V/F SVC FVC PMVF PMSVC PMFVC Used to set the running direction and acceleration and deceleration time of 5th stage.	0000 (0000~0031)

◇ F14.36: PLC 6th Stage Direction And Acceleration And Deceleration Time

Parameter Code (Address)	Name	Description	Default (Range)
F14.36 (0x0E24) RUN	Direction and Acceleration/Deceleration Time of PLC Segment 6	V/F SVC FVC PMVF PMSVC PMFVC Used to set the running direction and acceleration and deceleration time of 6th stage.	0000 (0000~0031)

◇ F14.37: PLC 7th Stage Direction And Acceleration And Deceleration Time

Parameter Code (Address)	Name	Description	Default (Range)
F14.37 (0x0E25) RUN	Direction and Acceleration/Deceleration Time of PLC Segment 7	V/F SVC FVC PMVF PMSVC PMFVC Used to set the running direction and acceleration and deceleration time of 7th stage.	0000 (0000~0031)

◇ F14.38: PLC 8th Stage Direction And Acceleration And Deceleration Time

Parameter Code (Address)	Name	Description	Default (Range)
F14.38 (0x0E26) RUN	Direction and Acceleration/Deceleration Time of PLC Segment 8	V/F SVC FVC PMVF PMSVC PMFVC Used to set the running direction and acceleration and deceleration time of 8th stage.	0000 (0000~0031)

◇ F14.39: PLC 9th Stage Direction And Acceleration And Deceleration Time

Parameter Code (Address)	Name	Description	Default (Range)
F14.39 (0x0E27) RUN	Direction and Acceleration/Deceleration Time of PLC Segment 9	V/F SVC FVC PMVF PMSVC PMFVC Used to set the running direction and acceleration and deceleration time of 9th stage.	0000 (0000~0031)

◇ F14.40: PLC 10th Stage Direction And Acceleration And Deceleration Time

Parameter Code (Address)	Name	Description	Default (Range)
F14.40 (0x0E28) RUN	Direction and Acceleration/Deceleration Time of PLC Segment 10	V/F SVC FVC PMVF PMSVC PMFVC Used to set the running direction and acceleration and deceleration time of 10th stage.	0000 (0000~0031)

◇ F14.41: PLC 11th Stage Direction And Acceleration And Deceleration Time

Parameter Code (Address)	Name	Description	Default (Range)
F14.41 (0x0E29) RUN	Direction and Acceleration/Deceleration Time of PLC Segment 11	V/F SVC FVC PMVF PMSVC PMFVC Used to set the running direction and acceleration and deceleration time of 11th stage.	0000 (0000~0031)

◇ F14.42: PLC 12th Stage Direction And Acceleration And Deceleration Time

Parameter Code (Address)	Name	Description	Default (Range)
F14.42 (0x0E2A) RUN	Direction and Acceleration/Deceleration Time of PLC Segment 12	V/F SVC FVC PMVF PMSVC PMFVC Used to set the running direction and acceleration and deceleration time of 12th stage.	0000 (0000~0031)

◇ F14.43: PLC 13th Stage Direction And Acceleration And Deceleration Time

Parameter Code (Address)	Name	Description	Default (Range)
F14.43 (0x0E2B) RUN	Direction and Acceleration/Deceleration Time of PLC Segment 13	V/F SVC FVC PMVF PMSVC PMFVC Used to set the running direction and acceleration and deceleration time of 13th stage.	0000 (0000~0031)

◇ F14.44: PLC 14th Stage Direction And Acceleration And Deceleration Time

Parameter Code (Address)	Name	Description	Default (Range)
F14.44 (0x0E2C) RUN	Direction and Acceleration/Deceleration Time of PLC Segment 14	V/F SVC FVC PMVF PMSVC PMFVC Used to set the running direction and acceleration and deceleration time of 14th stage.	0000 (0000~0031)

◇ F14.45: PLC 15th Stage Direction And Acceleration And Deceleration Time

Parameter Code (Address)	Name	Description	Default (Range)

F14.45 (0x0E2D) RUN	Direction and Acceleration/Deceleration Time of PLC Segment 15	V/F SVC FVC PMVF PMSVC PMFVC Used to set the running direction and acceleration and deceleration time of 15th stage.	0000 (0000~0031)
---------------------------	--	---	---------------------

LED"0": running direction of this stage

0: Forward

1: Reverse

Note: when the running direction is in reverse, you must set the F07.05 LED"00" as 0 and the F07.05 LED"000" as 1.

LED"00": Acceleration/deceleration time of this stage

0: Acceleration/deceleration time 1

1: Acceleration/deceleration time 2

2: Acceleration/deceleration time 3

3: Acceleration/deceleration time 4

LED"000": Reserved**LED"0000": Reserved****11.17 Group F15: Reserved****11.18 Group F16: Tension Control**✧ **F16.01: Winding Mode Settings**

Parameter Code (Address)	Name	Description	Default (Range)
F16.01 (0x5001) RUN	Winding mode setting	SVC FVC PMSVC PMFVC 0: Winding 1: Unwinding 2: Terminal selection	0 (0~2)

0: Winding when the winding mode is selected for tension control, the tension direction is fixed and is the running direction of the system, staying the same as the running direction during speed control.

1: Unwinding when the unwinding mode is selected for tension control, the tension direction is opposite to the running direction of the system, staying the same as the running direction during speed control.

2: Terminal control when the multi-functional input terminal is set as "94: Switch between rewind and unwind", switchover between rewinding and unwinding modes can also be carried out. See Multi-functional Input Terminal for details.

Note: Operation of switchover between winding and unwinding may not be started until the machine is stop, the roll diameter is reset to zero, and the correct initial roll diameter value is set.

◇ F16.02: Mechanical Transmission Ratio

Parameter Code (Address)	Name	Description	Default (Range)
F16.02 (0x5002) RUN	Mechanical transmission ratio	SVC FVC PMSVC PMFVC Set the transmission ratio between the motor and the roll.	1.00 (0.01~300.00)

Mechanical transmission ratio: refers to the speed reducing ratio from the drive motor output speed to the winding roller speed or unwind roller speed.

Mechanical transmission ratio = motor output speed / winding or unwinding reel speed

Mechanical transmission ratio is very important in tension control. Therefore, mechanical transmission ratio must be correctly set.

F16.03~F16.09: Tension Setting

◇ F16.03: Tension Given Selection

Parameter Code (Address)	Name	Description	Default (Range)
F16.03 (0x5003) STOP	Tension given selection	SVC FVC PMSVC PMFVC Used to set the tension given channel.	0000 (0000~0266)

LED"0": Tension given channel A

0: Tension given by keypad digital Tension is set and modified by the tension number setting of parameter [F16.04].

1: Reserved

2: AI1 setting Tension is set and modified by the input analog (AI1).

3: AI2 setting Tension is set and modified by the input analog (AI2).

4: Reserved

5: PUL setting Tension is set and modified by the terminal (PUL) input pulse signal.

6: RS485 communication setting (0x300B) Tension is controlled by the signal received at RS485 communication ports (A+) and (B-).

LED"00": Tension given channel B

0: Tension given by keypad digital Tension is set and modified by the tension number setting of parameter [F16.04].

1: Reserved

2: AI1 setting Tension is set and modified by the input analog (AI1).

3: AI2 setting Tension is set and modified by the input analog (AI2).

4: Reserved

5: PUL setting Tension is set and modified by the terminal (PUL) input pulse signal.

6: RS485 communication setting (0x300B) Tension is controlled by the signal received at RS485 communication ports (A+) and (B-).

The tension setting channel can be switched over by setting the multi-functional input terminal "92: Tension Setting Channel Switchover" during downtime. It is set by the tension setting channel at the LED LED"0" be default when the terminal is invalid. It is set by the tension setting channel at the LED LED"00" when the terminal is valid.

LED"000": Decimal point digits of tension setting

0: 0.1 unit All tension setting values (all channels) have one decimal place. It is recommended for use by low power models with higher accuracy.

1: 1 unit There is no decimal place in tension setting values (all channels).

2: 10 unit The tension set point (all channels) is the actual channel value times 10. It is recommended for use by high power models.

✧ **F16.04: Tension Keypad Digital Given**

Parameter Code (Address)	Name	Description	Default (Range)
F16.04 (0x5004) STOP	Tension keypad digital given	SVC FVC PMSVC PMFVC Set and modifies tension with keypad digital.	0.0N (0.0N ~ maximum tension. There is no decimal point for motor power above 37kW)

When tension setting selection [F16.03] is set as "0: Keypad number setting", this parameter is used to set and modify Keypad number setting tension.

✧ **F16.05: Maximum Tension**

Parameter Code (Address)	Name	Description	Default (Range)
F16.05 (0x5005) STOP	Maximum tension	SVC FVC PMSVC PMFVC Set the maximum tension limit for all channels.	1000N (0.0N ~ 6000.0N. There is no decimal point for motor power above 37kW)

This parameter is the maximum tension that the frequency drive allows to be set. When tension setting selected for [F16.03] is 1~5, this maximum value corresponds to the maximum analog input value or the maximum pulse input frequency. When the tension PID function is enabled, this value should be set to the tension sensor range so that the setting is the same as the feedback range.

✧ **F16.06: Tension Taper Coefficient**

Parameter Code (Address)	Name	Description	Default (Range)
F16.06 (0x5006) STOP	Tension taper coefficient	SVC FVC PMSVC PMFVC Set the tension taper coefficient.	0.0% (0.0%~100.0%)

This parameter is valid in winding mode and is used to control the curling and forming of winding material. During the winding process, tension is sometimes required to decrease accordingly as the roll diameter increases so as to ensure good curling and forming of the material.

$$\text{Actual output tension} = \text{Set tension} \times \left\{ 1 - \text{Tension taper} \times \left[1 - \frac{\left(\frac{\text{Initial roll diameter} + \text{Taper compensation correction}}{\text{Current roll diameter} + \text{Taper compensation correction}} \right)}{\left(\frac{\text{Current roll diameter} + \text{Taper compensation correction}}{\text{Current roll diameter} + \text{Taper compensation correction}} \right)} \right] \right\}$$

As the tension taper coefficient increases, the tension of outward forming during the winding process will decrease increasingly faster as the roll diameter increases. On the contrary, as the tension taper coefficient decreases, the tension of outward forming during the winding process will decrease very slowly as the roll diameter increases. When fine adjustment of tension taper becomes necessary, correction can be made by adjusting [F16.07] taper compensation correction.

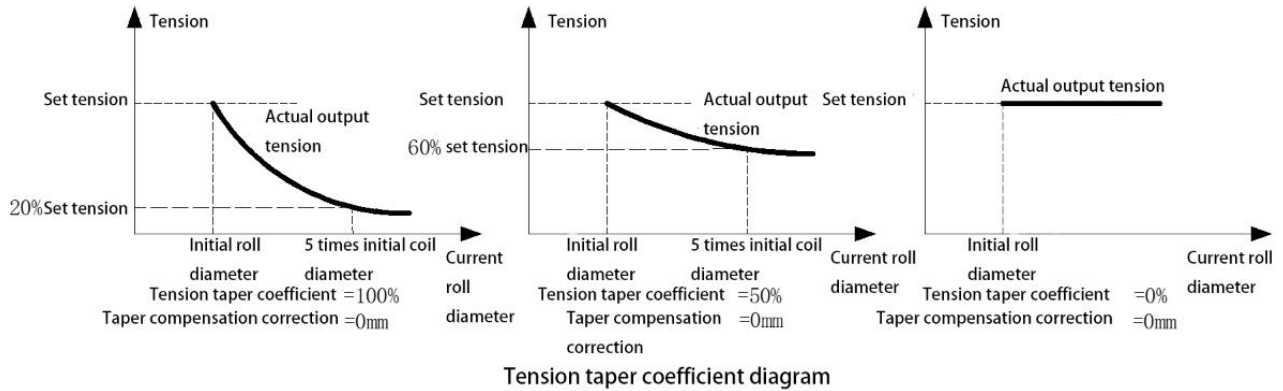

◇ **F16.07: Taper Compensation Correction**

Parameter Code (Address)	Name	Description	Default (Range)
F16.07 (0x5007) STOP	Taper compensation correction	SVC FVC PMSVC PMFVC Set the taper compensation correction coefficient.	0mm (0mm~10000mm)

Auxiliary parameter for tension taper control. Once tension taper is properly adjusted, increasing the value of this parameter can slow down the decreasing trend of output tension as the roll diameter increases. On the contrary, decreasing this value can allow the output tension to decrease faster as the roll diameter increases.

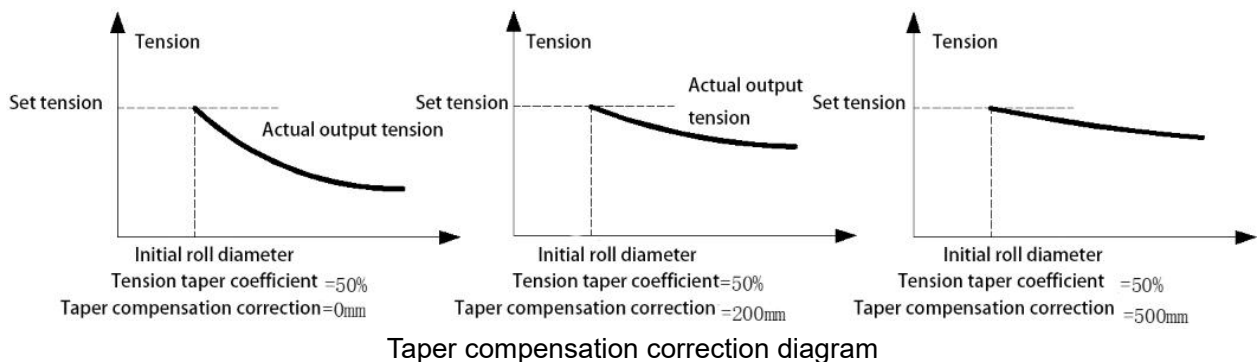

◇ **F16.08~F16.09: Zero Speed Tension**

Parameter Code (Address)	Name	Description	Default (Range)
F16.08 (0x5008) RUN	Zero speed threshold	SVC FVC PMSVC PMFVC Set the zero speed threshold.	1.00Hz (0.00Hz~50.00Hz)
F16.09 (0x5009) RUN	Zero speed tension gain	SVC FVC PMSVC PMFVC Set the tension gain value in zero speed mode.	100.0% (0.0%~500.0%)

Zero speed threshold: When the running frequency is below this set point, the frequency drive identifies it as zero speed working state.

Zero speed tension gain: the tension gain of the frequency drive under zero speed working conditions that is mainly used to maintain certain tension at the zero speed of the frequency drive. This value is based on the set tension, and is 100% corresponds to the tension set point.

F16.12 ~ F16.16: Friction Compensation

Parameter Code (Address)	Name	Description	Default (Range)
F16.12 (0x500C) RUN	Static friction compensation coefficient	SVC FVC PMSVC PMFVC Set the static friction compensation coefficient.	0.0% (0.0%~50.0%)
F16.13 (0x500D) RUN	Static friction compensation delay time	SVC FVC PMSVC PMFVC Set the static friction compensation delay time.	2.0s (0.0s~60.0s)
F16.14 (0x500E) RUN	Static friction compensation cutoff frequency	SVC FVC PMSVC PMFVC Set the static friction compensation cutoff frequency.	2.00 Hz (0.00 Hz - maximum frequency)
F16.15 (0x500F) RUN	Start coefficient of sliding friction compensation	SVC FVC PMSVC PMFVC Set the start coefficient of sliding friction compensation.	0.0% (0.0%~50.0%)
F16.16 (0x5010) RUN	End coefficient of sliding friction compensation	SVC FVC PMSVC PMFVC Set the end coefficient of sliding friction compensation.	0.0% (0.0%~50.0%)

Static friction compensation and sliding friction compensation are used to compensate friction loss during startup and operation of the system. Setting appropriate friction compensation values will allow the entire system to obtain good dynamic performance.

Static friction compensation coefficient: This coefficient corresponds 100% to the rated torque of the motor.

Static friction compensation delay time: Provides [F16.12] static friction compensation coefficient compensation within such delay time following system startup.

Static friction compensation cutoff frequency: If the current frequency is lower than such static friction compensation cutoff frequency upon completion of [F16.13] delay, the system will continue to provide static friction compensation (until the frequency becomes equal to such static friction compensation cutoff frequency); if the current frequency is higher than or equal to the static friction compensation cutoff frequency, the static friction coefficient compensation will decrease to 0 linearly.

Sliding friction compensation initial coefficient: This coefficient corresponds 100% to the rated torque of the motor and corresponds to the compensation at 0Hz.

Sliding friction compensation ending coefficient: This coefficient corresponds 100% to the rated torque of the motor and corresponds to compensation at [F01.10] maximum frequency.

The sliding friction compensation linearity between 0 and maximum frequency can be set via the two parameters mentioned above.

F16.30~F16.32: Material Interruption Detection

Parameter Code (Address)	Name	Description	Default (Range)
F16.30 (0x501E) RUN	Material Interruption Detection Selection	SVC FVC PMSVC PMFVC LED"0": Detection Signal Input Source 0: Material interruption detection Invalid 1: Keypad potentiometer setting 2: AI1 3: AI2 4: Reserved 5: PUL LED"00": Material Interruption Handling 0: Alarm, continues operation 1: Failure stop	0000 (0000~0015)
F16.31 (0x501F) RUN	Material Interruption Detection Threshold	SVC FVC PMSVC PMFVC Set the material interruption detection threshold.	100.0% (0.0%~100.0%)
F16.32 (0x5020) RUN	Material Interruption Detection Delay	SVC FVC PMSVC PMFVC Set the material interruption detection delay.	2.0s (0.1s~60.0s)

The above mentioned three parameters are set to provide material interruption detection in tension mode. Practical effects can be obtained by adjusting [F16.31 - F16.32].

Selection and handling of material interruption detection:

LED"0": detection signal input source:

0: Material interruption detection Invalid Turn off the material interruption detection function.

1: Keypad potentiometer setting (output single-line Keypad is optional)

2: AI1 setting Detection signal is set by the terminal (AI1) input analog.

3: AI2 setting Detection signal is set by the terminal (AI2) input analog.

4: Reserved

5: PUL setting Detection signal is set by the terminal (PUL) input pulse signal.

LED"00": Material interruption handling method:

0: Alarm, continues operation

1: Failure stop

The frequency drive reports E. FrA fault or triggers A. FrA warning when material interruption is detected.

Material interruption detection judgment threshold: Material interruption is detected when the material interruption detection function is Valid and when the external feedback signal input from [F16.30] LED LED"0": detection signal input source exceeds the material interruption detection judgment threshold. This value corresponds 100% to the maximum input of the detection signal input source.

Material interruption detection judgment delay: Material interruption is determined when the material interruption detection function is valid and when the external feedback signal inputted from [F16.30] LED LED"0": detection signal input source exceeds the [F16.31] material interruption detection judgment threshold and the time of duration exceeds the material interruption detection judgment delay.

F16.36~F16.38: Pre-drive

Parameter Code (Address)	Name	Description	Default (Range)
F16.36 (0x5024) STOP	Pre-drive function selection	SVC FVC PMSVC PMFVC 0: Pre-drive invalid 1: Manual selection 2: Automatic selection	0 (0~2)
F16.37	Pre-drive frequency	SVC FVC PMSVC PMFVC	105.0%

(0x5025) STOP	gain	Sets the pre-drive frequency gain.	(0.0%~200.0%)
F16.38 (0x5026) STOP	Pre-drive torque gain	SVC FVC PMSVC PMFVC Sets the pre-drive torque gain.	105.0% (0.0%~200.0%)

When changing the coil during operation, you must rotate the winding reel in advance. In order to prevent excessive impact, the linear speed of winding should be the same as the linear speed of the material during operation. The frequency drive will allow the linear speeds to match by automatically calculating the output frequency based on the detected linear speeds and roll diameter. This is the pre-drive function. The pre-drive function is only valid during winding and is only valid when the roll diameter is calculated using the linear speed.

Pre-drive function selection:

0: Pre-drive is invalid performing pre-drive by the frequency drive is not allowed when pre-drive is invalid.

1: Manual selection the system enters into pre-drive when the multi-functional terminal "95: Pre-drive Selection" is valid; the system exits pre-drive when the terminal is invalid. This terminal does not have the operation function.

2: Automatic selection By default, the system enters into the pre-drive mode automatically upon each startup. The frequency drive automatically determines exit of pre-drive through torque and frequency.

Pre-drive frequency gain: system error may lead to deviation in the matching between calculated pre-drive frequency and linear speed. Adjusting this parameter properly can achieve an accurate linear speed matching during debugging.

Pre-drive torque gain: this parameter is used to compensate for shortage of torque provided by the frequency drive during pre-drive. When pre-drive ends, the torque gain is linearly reduced to 100.0%.

F16.42~F16.43: Stop and Brake Hold

Parameter Code (Address)	Name	Description	Default (Range)
F16.42 (0x502A) RUN	Stop and braking hold frequency	SVC FVC PMSVC PMFVC Set the threshold value for stop and braking hold judgment frequency.	2.00 Hz (0.01 Hz - maximum frequency)
F16.43 (0x502B) RUN	Stop and braking hold time	SVC FVC PMSVC PMFVC Set the stop and braking hold time.	0.0s (0.0s~600.0s)

Define the output terminal as "33: stop braking signal" under tension control. When the frequency drive stop and decelerates to the stop braking frequency [F16.42], the corresponding output terminal outputs valid signal, and outputs invalid signal following the continuous stop braking time [F16.43].

F16.44~F16.55: Roll Diameter Parameter Setting

◇ F16.44: Roll diameter calculation method selection

Parameter Code (Address)	Name	Description	Default (Range)
F16.44 (0x502C) STOP	Roll diameter calculation method selection	SVC FVC PMSVC PMFVC 0: Initial roll diameter, not calculated 1: Calculated with linear velocity 2: Calculated with thickness 3: Reserved 4: Set with AI1 5: Set with AI2 6: Reserved 7: Set with PUL 8: RS485 communication setting (0x300C)	0 (0~8)

This parameter is used to select the roll diameter calculation method or the roll diameter input method. Calculation of the roll diameter during the winding process will directly affect tension control of the frequency drive. A reasonable roll diameter input method can help better control the tension.

0: Initial roll diameter, not calculated The frequency drive does not calculate the roll diameter, which is set as the initial roll diameter by default.

1: Calculate via linear speed The frequency drive calculates the roll diameter based on the linear speed and the output frequency of the frequency drive. See [F16.56] for details about linear speed source selection.

2: Calculate via thickness accumulation When this method is chosen to calculate the roll diameter, the thickness of the material must be set. The frequency drive calculates the roll diameter based on coil turn count signal accumulation, with winding as increment and unwinding as decrement. See related parameters section in [F16.68 - F16.70] calculate roll diameter by accumulated thickness for relevant functions.

3: Reserved

4: AI1 setting The roll diameter is obtained by inputting the control terminal (AI1) input analog.

5: AI2 setting The roll diameter is obtained by inputting the control terminal (AI2) input analog.

6: Reserved

7: PUL setting The roll diameter is obtained by the PUL port input.

8: RS485 communication setting (0x300C) The roll diameter is obtained by the RS485 communication setting.

Note: when the roll diameter value is set by the analog, there is a linear relationship between the maximum value of its analog input and the [F16.45] maximum roll diameter. When the initial roll diameter is set by PUL, there is a linear relationship between the maximum value of its PUL frequency and the [F16.45] maximum roll diameter.

◇ F16.45: Maximum Roll Diameter

Parameter Code (Address)	Name	Description	Default (Range)
F16.45 (0x502D) STOP	Maximum roll diameter	SVC FVC PMSVC PMFVC Set the maximum roll diameter limit.	500 mm (1 mm - maximum roll diameter)

Maximum roll diameter: the maximum roll diameter allowed by the frequency drive during winding. All roll diameter setting methods and results will be restricted by the maximum roll diameter. Setting should be made after accurate calculation or measurement of the actual maximum roll diameter value.

◇ F16.46: Roll Shaft Diameter

Parameter Code (Address)	Name	Description	Default (Range)
F16.46 (0x502E) STOP	Roll shaft diameter	SVC FVC PMSVC PMFVC Set the roll shaft diameter value.	100 mm (1 mm~maximum roll diameter)

Roll Shaft Diameter: Refers to the diameter of the coil when it is empty. This value is used both as the default initial roll diameter for winding and as the lower limit of the calculated value of the roll diameter. It is very important to set the reel diameter accurately.

◇ F16.47: Initial Roll Diameter Source Selection

Parameter Code (Address)	Name	Description	Default (Range)
F16.47 (0x502F) STOP	Initial roll diameter source selection	SVC FVC PMSVC PMFVC 0: Terminal selection F16.48~F16.50 1: Reserved 2: AI1 3: AI2 4: Reserved 5: PUL	0 (0~5)

This parameter is used to select the setting method for the initial roll diameter.

0: Terminal selection Select the initial roll diameter value by switching terminals; see parameter [F16.48 - F16.50] for details.

1: Reserved

2: AI1 The initial roll diameter is set and modified by the terminal (AI1) input analog.

3: AI2 The initial roll diameter is set and modified by the terminal (AI2) input analog.

4: Reserved

5: PUL The initial roll diameter is set and modified by the terminal (PUL) input pulse signal.

Note: When the initial roll diameter is set by the analog, there is a linear relationship between the maximum value of its analog input and the [F16.45] maximum roll diameter. When the initial roll diameter is set by PUL, there is a linear relationship between the maximum value of its PUL frequency and the [F16.45] maximum roll diameter.

◇ F16.48~F16.50: Initial Roll Diameter

Parameter Code (Address)	Name	Description	Default (Range)
F16.48 (0x5030) RUN	Initial roll diameter 1	SVC FVC PMSVC PMFVC Set initial roll diameter 1.	100 mm (1 mm~maximum roll diameter)
F16.49 (0x5031) RUN	Initial roll diameter 2	SVC FVC PMSVC PMFVC Set initial roll diameter 2.	100 mm (1 mm~ maximum roll diameter)
F16.50 (0x5032) RUN	Initial roll diameter 3	SVC FVC PMSVC PMFVC Set initial roll diameter 3.	100 mm (1 mm~ maximum roll diameter)

When the initial roll diameter source [F16.47] selection is set as "0 (terminal selection)", you can define any multi-functional terminal as "89/90: initial roll diameter setting terminal", see parameter [F5.0x digital input terminal function selection] for details. Set the initial roll diameter by switching terminals, see table below for the corresponding relationship between terminal status and initial roll diameter;

Initial roll diameter	Initial roll diameter selection	Initial roll diameter
-----------------------	---------------------------------	-----------------------

selection terminal 1	terminal 2	
OFF	OFF	Reel diameter [F16.46].
ON	OFF	Initial roll diameter 1.
OFF	ON	Initial roll diameter 2.
ON	ON	Initial roll diameter 3.

Note: when all multi-functional terminals are in the OFF state, the initial roll diameter is the reel diameter [F16.46] set point.

◇ F16.51: Roll Diameter Reset Selection

Parameter Code (Address)	Name	Description	Default (Range)
F16.51 (0x5033) RUN	Roll diameter reset selection	SVC FVC PMSVC PMFVC 0: Manual reset of roll diameter 1: Automatic reset of roll diameter	0 (0~1)

0: Manual reset of roll diameter When manual reset is selected, you must define any one of the multi-functional terminals as "88: roll diameter reset terminal". When the roll diameter reset terminal is valid, the roll diameter value of the frequency drive restores to the initial value. Manual reset of roll diameter is only valid during stop.

1: Automatic reset of roll diameter When automatic reset of roll diameter is selected, the frequency drive restores the roll diameter to the initial value automatically after stop.

◇ F16.54~F16.55: Winding Change Limit

Parameter Code (Address)	Name	Description	Default (Range)
F16.54 (0x5036) RUN	Roll diameter change rate limit	SVC FVC PMSVC PMFVC Set the limit of roll diameter change rate.	10.00mm/s (0.00mm/s~ 200.00mm/s)
F16.55 (0x5037) RUN	Roll diameter change limit	SVC FVC PMSVC PMFVC Set the limit of roll diameter change direction.	0 (0~1)

Roll diameter rate of change restriction: Setting this parameter to 0 means there is no restriction on roll diameter changes. When it is set as other than 0, this parameter will restrict the amount of change of roll diameter during unit time so as to avoid sudden change of roll diameter when roll diameter calculation becomes abnormal. Please note: the time response of torque may be affected if this value is set too small. This value should be set after accurate calculation.

Restrictions for roll diameter change direction:

0: No limit

1: Decrement is prohibited during winding; increment is prohibited during unwinding

F16.56~F16.63: Roll Diameter Calculation with Linear Velocity

◇ F16.56: Linear Speed Input Source

Parameter Code (Address)	Name	Description	Default (Range)
F16.56 (0x5038) RUN	Linear velocity input source	SVC FVC PMSVC PMFVC 0: Terminal selection F16.60/F16.61 1: Keypad digital 2: Reserved	0 (0~7)

		3: AI1 4: AI2 5: Reserved 6: PUL 7: RS485 communication setting (0x300D)	
--	--	--	--

This parameter is valid only when the [F16.44] roll diameter calculation method selection is set as "1: calculate via linear speed".

0: F16.60/F16.61 terminal selection Select the traction linear speed value by switching terminals; see parameter [F16.60 - F16.61] for details.

1: Keypad number setting Linear speed is set and modified by [F16.58].

2: Reserved

3: AI1 Linear speed is set and modified by the terminal (AI1) input analog.

4: AI2 Linear speed is set and modified by the terminal (AI2) input analog.

5: Reserved

6: PUL Linear speed is set and modified by the terminal (PUL) input pulse signal.

7: RS485 communication setting (0x300D) Linear speed is set and modified by RS485 communication.

Note: The traction linear speed must be obtained accurately when the linear speed calculation method is used during winding. A commonly used method is to obtain the traction linear speed by feeding the output frequency of the frequency drive that drives the traction motor into the winding frequency drive through the analog output terminal. When the linear speed is set by the analog, there is a linear relationship between the maximum value of its analog input and the [F16.57] maximum linear speed. When the linear speed is set by PUL, there is a linear relationship between the maximum value of its PUL frequency and the [F16.57] maximum linear speed.

◇ **F16.57: Maximum Linear Speed**

Parameter Code (Address)	Name	Description	Default (Range)
F16.57 (0x5039) RUN	Maximum linear velocity	SVC FVC PMSVC PMFVC Set the maximum linear velocity limit for all channels.	1000.0m/min (0.0m/min~6500.0m/min)

Maximum linear speed: All channels of the linear speed input source are restricted by this maximum linear speed. The maximum linear speed determines the current linear speed. This parameter should be set after accurate calculation or measurement of the actual maximum linear speed.

◇ **F16.58: Numeric Setting of Linear Speed**

Parameter Code (Address)	Name	Description	Default (Range)
F16.58 (0x503A) RUN	Keypad digital setting of linear velocity	SVC FVC PMSVC PMFVC Set and modifies the linear speed given with the keypad.	20.0 (0.0 ~ maximum linear speed)

Numeric Setting of Linear Speed: Set the value of given linear speed when the [F16.56] linear speed input source is "1: Keypad number setting".

◇ **F16.59: Roll Diameter Calculation Minimum Linear Speed**

Parameter Code (Address)	Name	Description	Default (Range)
F16.59 (0x503B) RUN	Roll diameter calculation minimum linear	SVC FVC PMSVC PMFVC Set the minimum linear speed when calculating the roll diameter with linear speed.	2.0 (0.0 ~ maximum linear speed)

	speed		
--	-------	--	--

Set the minimum linear speed for starting the roll diameter calculation. When the linear speed detected by the frequency drive is less than this value, the frequency drive will stop roll diameter calculation and keep the current roll diameter value. Setting this value correctly can effectively prevent large deviation in roll diameter calculation when the linear speed is low. This parameter is only useful when the roll diameter is calculated using the linear speed.

◇ F16.60~F16.61: Linear Speed Given

Parameter Code (Address)	Name	Description	Default (Range)
F16.60 (0x503C) RUN	Linear speed given 1	SVC FVC PMSVC PMFVC Set the set point 1 of linear speed.	20.0 (0.0 ~ maximum linear speed)
F16.61 (0x503D) RUN	Linear speed given 2	SVC FVC PMSVC PMFVC Set the set point 2 of linear speed.	20.0 (0.0 ~ maximum linear speed)

When the [F16.56] linear speed input source selection is set as "0: F16.60/F16.61 terminal selection", you can define any multi-functional terminal as "91: linear speed selection terminal" and set the traction linear speed by switching terminals. See the table below for the corresponding relationship between terminal status and linear speed:

Linear speed selection terminal	Linear speed set point
OFF	Linear speed set point 1.
ON	Linear speed set point 2.

◇ F16.63: Roll Diameter Calculation Minimum Frequency

Parameter Code (Address)	Name	Description	Default (Range)
F16.63 (0x503F) RUN	Minimum frequency for roll diameter calculation	SVC FVC PMSVC PMFVC Set the minimum frequency when calculating the roll diameter with linear velocity.	1.00Hz (0.00Hz~10.00Hz)

When the winding and unwinding frequency value is less than or equal to the roll diameter calculation minimum frequency, the system does not carry out roll diameter calculation, and the current roll diameter value is kept unchanged. This parameter is only useful when the roll diameter is calculated using the linear speed.

F16.68~F16.70: Roll Diameter Calculation with Thickness

Parameter Code (Address)	Name	Description	Default (Range)
F16.68 (0x5044) RUN	Number of pulses per turn of winding roller	SVC FVC PMSVC PMFVC Set the number of pulses received for each turn the winding roller rotates when calculating the roll diameter with thickness.	1 (1~65000)
F16.69 (0x5045) RUN	Number of turns per layer	SVC FVC PMSVC PMFVC Set the number of turns required for winding a layer on the roll.	1 (1~10000)
F16.70 (0x5046) RUN	Material thickness set with numbers	SVC FVC PMSVC PMFVC Set the thickness of material.	0.01mm (0.01mm~100.00mm)

When the roll diameter calculation method selection [F16.44] is set as "2: calculate via thickness accumulation", the [F16.68 -

F16.70] parameter is valid. When using this method to perform roll diameter calculation, you should correctly set **the [F08.00/F08.01]** pulse input method and counting frequency division value. The corresponding roll diameter reset operation should be performed after coil change.

Number of pulses per turn: Number of pulses generated when the winding roller rotates for one turn during winding operation. Please note that this number of pulses is that before frequency division by **[F08.01]**. i.e., when the **[F08.00]** pulse input method is selected as "2: PG pulse input", the **[F16.68]** number of pulses per turn of winding roller should be set as the actual number of points of the encoder times the mechanical transmission ratio.

Number of turns per layer: Number of turns to be wound for the winding reel to wind one full layer.

Material thickness number setting: This parameter is used to set material thickness.

The roll diameter calculation formula obtained is as follows:

$$\text{Current roll diameter} = \text{Initial roll diameter} \pm 2 * \text{Total number of pulses} * [\text{F16.70}] / ([\text{F16.68}] * [\text{F16.69}])$$

F16.75~F16.82: Tension PID

In circumstances where tension sensor is installed, constant tension of the material can be maintained by using the tension PID function.

◇ **F16.75: Tension PID Enabled**

Parameter Code (Address)	Name	Description	Default (Range)
F16.75 (0x504B) STOP	Enable tension PID	SVC FVC PMSVC PMFVC 0: Not enabled 1: Enabled	0 (0~1)

Tension PID enabled:

0: Not enabled Tension PID function does not work.

1: Enabled Tension PID function does work.

◇ **F16.76: Tension PID Output Reference Source**

Parameter Code (Address)	Name	Description	Default (Range)
F16.76 (0x504C) STOP	Tension PID output reference source	SVC FVC PMSVC PMFVC 0: Given tension as the reference source. 1: Maximum tension as the reference source.	0 (0~1)

Tension PID output reference source:

0: Set tension as reference source

1: Maximum tension as reference source

◇ **F16.77: Tension PID Maximum Output Ratio**

Parameter Code (Address)	Name	Description	Default (Range)
F16.77 (0x504D) RUN	Tension PID maximum output percentage	SVC FVC PMSVC PMFVC Set the percentage of tension PID output.	10.0% (0.0%~50.0%)

Tension PID maximum output ratio: the percentage of tension it stands for in the [F16.76] reference source when the PID output set by this parameter reaches the maximum value (100%).

◇ **F16.78: Tension PID Feedback Signal Source**

Parameter Code (Address)	Name	Description	Default (Range)
F16.78 (0x504E) RUN	Tension PID feedback signal source	SVC FVC PMSVC PMFVC 0: PID feedback with keypad digital 1: Reserved 2: Voltage analog AI1 feedback 3: Current/voltage analog AI2 feedback 4: Reserved 5: Terminal pulse PUL feedback 6: RS485 communication feedback (0x300E)	2 (0~6)

Set input channel for the tension PID controller feedback signal.

0: Keypad number PID feedback Determine the set point of [F16.78] as the PID feedback channel.

1: Reserved

2: Analog AI1 feedback The PID feedback channel is analog AI1.

3: Analog AI2 feedback The PID feedback channel is analog AI2.

4: Reserved

5: Terminal pulse PUL feedback The PID feedback channel is terminal pulse PUL.

6: RS485 communication feedback The PID feedback channel is RS485 communication and the communication address is 0x300E/0x200E.

✧ **F16.79: Tension PID Keypad Feedback Set with Keypad Digital**

Parameter Code (Address)	Name	Description	Default (Range)
F16.79 (0x504F) RUN	Tension PID keypad feedback Set with keypad digital	SVC FVC PMSVC PMFVC Set and modifies the tension PID keypad feedback set with keypad digital.	50.0% (0.0%~100.0%)

Tension PID keypad number feedback setting: when the tension PID feedback signal source [F16.78] is set as "0: Keypad number PID feedback", this parameter is used to set and modify the keypad number PID feedback.

✧ **F16.80: Tension PID Feedback Signal Gain**

Parameter Code (Address)	Name	Description	Default (Range)
F16.80 (0x5050) RUN	Tension PID feedback signal gain	SVC FVC PMSVC PMFVC Set the gain of PID feedback signals for all channels.	1.00 (0.00~10.00)

✧ **F16.81~F16.82: Tension PI Parameters**

Parameter Code (Address)	Name	Description	Default (Range)
F16.81 (0x5051) RUN	Proportional gain P	SVC FVC PMSVC PMFVC Set the tension PID proportional gain.	0.500 (0.000~8.000)
F16.82 (0x5052) RUN	Integral time T	SVC FVC PMSVC PMFVC Set the tension PID integral time.	0.5s (0.0s~600.0s)

The adjustment parameters of the PID controller. The parameter values should be adjusted according to actual system characteristics.

Proportional gain: Determines the regulation intensity of the PID regulator. The higher the gain, the greater the regulation intensity. However, excessively high intensity may easily result in oscillation.

Integral time: Determines the integral regulation intensity of the PID regulator. The shorter the integral time, the greater the regulation intensity.

11.19 Group F17: Reserved

11.20 Group F18: Reserved

11.21 Group F19: User Programmable Group A

11.22 Group F20: User Programmable Group B

11.23 Group F21: Industry Application extension Group

11.24 Group F22: Reserved

11.25 Group F23: Reserved

11.26 Group F24: Reserved

11.27 Group F25: Calibration of Analog Input and Output (AI, AO)

This group of function codes is used to calibrate analog input (AI) and analog output (AO) so as to eliminate zero drift and gain effects brought by hardware circuits.

This group of functional parameters has been calibrated in factory, so the parameter values do not change when parameters are restored to Defaults. Calibration is generally not required at the application site.

Measured value: the actual value measured via a measuring instrument such as multimeter.

Monitored value: the value before calibration of the frequency drive, which is viewed via (C02.10, C02.11, C02.12).

During calibration, output the actual value and monitored value of each input or output port into the corresponding parameter and the frequency drive will conduct calibration automatically. Generally, three segments of different values are selected for calibration.

The input or output monitored value following calibration is basically the same as the actual value.

Calibrating relevant parameters:

Port	Type	Monitoring before calibration	Monitoring after calibration	Calibrating set parameters
AI1	Voltage (F05.41=0)	C02.10	C00.16	F25.00-F25.05
AI1	Current (F05.41=1)	C02.10	C00.16	F25.06-F25.11
AI2	Voltage (F05.42=0)	C02.11	C00.17	F25.12-F25.17
AI2	Current (F05.42=1)	C02.11	C00.17	F25.18-F25.23
AO	Voltage (F06.00=0)	C02.12	C00.20	F25.24-F25.29
AO	Current (F06.00=1, 2)	C02.12	C00.20	F25.30-F25.35

Note: when different signal types are selected, you must manually flip the selector switch. See "Changeover Switch Function Legend and Description" for details.

F25.00 ~ F25.11: AI1 Calibration Parameters

Parameter F5.41 is used to select voltage or current input. F5.41 set to "0" indicates voltage input, while "1" indicates current input.

◇ F25.00 - F25.05: AI1 Voltage Input Calibration

Parameter Code (Address)	Name	Description	Default (Range)
F25.00 (0x5900) RUN	AI1 measured voltage 1	V/F SVC FVC PMVF PMSVC PMFVC The first stage corrected voltage. The measured value is input into the parameter.	0.500V (0.000V~3.000V)
F25.01 (0x5901) RUN	AI1 monitor voltage 1	V/F SVC FVC PMVF PMSVC PMFVC The monitor value corresponding to the first stage corrected voltage. The value of C02.10 is input.	0.500V (0.000V~3.000V)
F25.02 (0x5902) RUN	AI1 measured voltage 2	V/F SVC FVC PMVF PMSVC PMFVC The second stage corrected voltage. The measured value is input into the parameter.	5.000V (0.000V~7.000V)
F25.03 (0x5903) RUN	AI1 monitor voltage 2	V/F SVC FVC PMVF PMSVC PMFVC The monitor value corresponding to the second stage corrected voltage. The value of C02.10 is input.	5.000V (0.000V~7.000V)
F25.04 (0x5904) RUN	AI1 measured voltage 3	V/F SVC FVC PMVF PMSVC PMFVC The third stage corrected voltage. The measured value is input into the parameter.	9.500V (0.000V~11.000V)

F25.05 (0x5905) RUN	AI1 monitor voltage 3	V/F SVC FVC PMVF PMSVC PMFVC The monitor value corresponding to the third stage corrected voltage. The value of C02.10 is input.	9.500V (0.000V~11.000V)
---------------------------	--------------------------	--	----------------------------

◇ **F25.06 - F25.11: AI1 Current Input Calibration**

Parameter Code (Address)	Name	Description	Default (Range)
F25.06 (0x5906) RUN	AI1 Measured Current 1	V/F SVC FVC PMVF PMSVC PMFVC The first stage corrected current. The measured value is input into the parameter.	1.000mA (0.000mA~6.000mA)
F25.07 (0x5907) RUN	AI1 Monitor Current 1	V/F SVC FVC PMVF PMSVC PMFVC The monitor value corresponding to the first stage corrected current. The value of C02.10 is input.	1.000mA (0.000mA~6.000mA)
F25.08 (0x5908) RUN	AI1 Measured Current 2	V/F SVC FVC PMVF PMSVC PMFVC The second stage corrected current. The measured value is input into the parameter.	10.000mA (0.000mA~14.000mA)
F25.09 (0x5909) RUN	AI1 Monitor Current 2	V/F SVC FVC PMVF PMSVC PMFVC The monitor value corresponding to the second stage corrected current. The value of C02.10 is input.	10.000mA (0.000mA~14.000mA)
F25.10 (0x590A) RUN	AI1 Measured Current 3	V/F SVC FVC PMVF PMSVC PMFVC The third stage corrected current. The measured value is input into the parameter.	19.000mA (0.000mA~21.000mA)
F25.11 (0x590B) RUN	AI1 Monitor Current 3	V/F SVC FVC PMVF PMSVC PMFVC The monitor value corresponding to the third stage corrected current. The value of C02.10 is input.	19.000mA (0.000mA~21.000mA)

F25.12 ~ F25.23: AI2 Calibration Parameters

Select voltage or current input by setting parameter F5.42. Setting F5.42 as "0" and "1" indicates voltage input and current input, respectively.

◇ **F25.12 - F25.17: AI2 Voltage Input Calibration**

Parameter Code (Address)	Name	Description	Default (Range)
F25.12 (0x590C) RUN	AI2 Measured Voltage 1	V/F SVC FVC PMVF PMSVC PMFVC The first stage corrected voltage. The measured value is input into the parameter.	0.500V (0.000V~3.000V)
F25.13 (0x590D) RUN	AI2 Monitor Voltage 1	V/F SVC FVC PMVF PMSVC PMFVC The monitor value corresponding to the first stage corrected voltage. The value of C02.11 is input.	0.500V (0.000V~3.000V)
F25.14 (0x590E) RUN	AI2 Measured Voltage 2	V/F SVC FVC PMVF PMSVC PMFVC The second stage corrected voltage. The measured value is input into the parameter.	5.000V (0.000V~7.000V)
F25.15 (0x590F) RUN	AI2 Monitor Voltage 2	V/F SVC FVC PMVF PMSVC PMFVC The monitor value corresponding to the second stage corrected voltage. The value of C02.11 is input.	5.000V (0.000V~7.000V)
F25.16 (0x5910) RUN	AI2 Measured Voltage 3	V/F SVC FVC PMVF PMSVC PMFVC The third stage corrected voltage. The measured value is input into the parameter.	9.500V (0.000V~11.000V)
F25.17 (0x5911) RUN	AI2 Monitor Voltage 3	V/F SVC FVC PMVF PMSVC PMFVC The monitor value corresponding to the third stage corrected voltage. The value of C02.11 is input.	9.500V (0.000V~11.000V)

◇ F25.18 - F25.23: AI2 Current Input Calibration

Parameter Code (Address)	Name	Description	Default (Range)
F25.18 (0x5912) RUN	AI2 Measured Current 1	V/F SVC FVC PMVF PMSVC PMFVC The first stage corrected current. The measured value is input into the parameter.	1.000mA (0.000mA~6.000mA)
F25.19 (0x5913) RUN	AI2 Monitor Current 1	V/F SVC FVC PMVF PMSVC PMFVC The monitor value corresponding to the first stage corrected current. The value of C02.11 is input.	1.000mA (0.000mA~6.000mA)
F25.20 (0x5914) RUN	AI2 Measured Current 2	V/F SVC FVC PMVF PMSVC PMFVC The second stage corrected current. The measured value is input into the parameter.	10.000mA (0.000mA~14.000mA)
F25.21 (0x5915) RUN	AI2 Monitor Current 2	V/F SVC FVC PMVF PMSVC PMFVC The monitor value corresponding to the second stage corrected current. The value of C02.11 is input.	10.000mA (0.000mA~14.000mA)
F25.22 (0x5916) RUN	AI2 Measured Current 3	V/F SVC FVC PMVF PMSVC PMFVC The third stage corrected current. The measured value is input into the parameter.	19.000mA (0.000mA~21.000mA)
F25.23 (0x5917) RUN	AI2 Monitor Current 3	V/F SVC FVC PMVF PMSVC PMFVC The monitor value corresponding to the third stage corrected current. The value of C02.11 is input.	19.000mA (0.000mA~21.000mA)

F25.24 - F25.35: AO Calibration Parameters

Select voltage or current output by setting parameter F6.00. Setting F6.00 as "0" and "1 or 2" indicates voltage output and current output, respectively.

Note: when calibrating AO output, you must set F6.02 as "100.0%" and F06.03 as "0.0", otherwise the linear ratio of calibration may be affected.

◇ F25.24 - F25.29: AO Voltage Output Calibration

Parameter Code (Address)	Name	Description	Default (Range)
F25.24 (0x5918) RUN	AO Measured Voltage 1	V/F SVC FVC PMVF PMSVC PMFVC The first stage corrected voltage. The measured value is input into the parameter.	0.500V (0.000V~3.000V)
F25.25 (0x5919) RUN	AO Monitor Voltage 1	V/F SVC FVC PMVF PMSVC PMFVC The monitor value corresponding to the first stage corrected voltage. The value of C02.12 is input.	0.500V (0.000V~3.000V)
F25.26 (0x591A) RUN	AO Measured Voltage 2	V/F SVC FVC PMVF PMSVC PMFVC The second stage corrected voltage. The measured value is input into the parameter.	5.000V (0.000V~7.000V)
F25.27 (0x591B) RUN	AO Monitor Voltage 2	V/F SVC FVC PMVF PMSVC PMFVC The monitor value corresponding to the second stage corrected voltage. The value of C02.12 is input.	5.000V (0.000V~7.000V)
F25.28 (0x591C) RUN	AO Measured Voltage 3	V/F SVC FVC PMVF PMSVC PMFVC The third stage corrected voltage. The measured value is input into the parameter.	9.500V (0.000V~11.000V)
F25.29 (0x591D) RUN	AO Monitor Voltage 3	V/F SVC FVC PMVF PMSVC PMFVC The monitor value corresponding to the third stage corrected voltage. The value of C02.12 is input.	9.500V (0.000V~11.000V)

◇ F25.30 - F25.35: AO Current Output Calibration

Parameter Code	Name	Description	Default (Range)
----------------	------	-------------	-----------------

(Address)			
F25.30 (0x591E) RUN	AO Measured Current 1	V/F SVC FVC PMVF PMSVC PMFVC The first stage corrected current. The measured value is input into the parameter.	1.000mA (0.000mA~6.000mA)
F25.31 (0x591F) RUN	AO Monitor Current 1	V/F SVC FVC PMVF PMSVC PMFVC The monitor value corresponding to the first correction current is input with C02.12 value.	1.000mA (0.000mA~6.000mA)
F25.32 (0x5920) RUN	AO Measured Current 2	V/F SVC FVC PMVF PMSVC PMFVC The second stage corrected current. The measured value is input into the parameter.	10.000mA (0.000mA~14.000mA)
F25.33 (0x5921) RUN	AO Monitor Current 2	V/F SVC FVC PMVF PMSVC PMFVC The monitor value corresponding to the second stage corrected current. The value of C02.12 is input.	10.000mA (0.000mA~14.000mA)
F25.34 (0x5922) RUN	AO Measured Current 3	V/F SVC FVC PMVF PMSVC PMFVC The third stage corrected current. The measured value is input into the parameter.	19.000mA (0.000mA~21.000mA)
F25.35 (0x5923) RUN	AO Monitor Current 3	V/F SVC FVC PMVF PMSVC PMFVC The monitor value corresponding to the third stage corrected current. The value of C02.12 is input.	19.000mA (0.000mA~21.000mA)