



YOUR SOLUTIONS TO MANAGE ENERGY
VOS SOLUTIONS POUR LA GESTION DE L'ÉNERGIE



TRUNKING SPECIALISTS

WHO WE ARE

CANALPLAST is, since more than 35 years, a specialized company in the production and development of trunking systems for electrical installation. Our effort, the technology of our production and the quality of our products bring our presence in the national markets and make us grow more and more towards the international ones, placing us among the leaders of the sector, with a network of agencies and own promoters that constantly cooperate with the clients and their design dept., and having as partners the distributors of electric material with which we collaborate for the "satisfaction of the end client".

A STRATEGIC STRUCTURE

CANALPLAST's facilities cover an area of more than 20.000 m². Using constantly updated technologies, **CANALPLAST** produces profiles made of high quality materials. These products follow a rigid quality control procedure, from production to packing and storing. **CANALPLAST**'s facilities house the Research and Development department, as well as administrative and production departments. Approximately 1500 stock items are stored in our 7.500 m² warehouse. A Customer Care department is in charge of coordinating all orders, from placement to final shipment to the customer.

SPÉCIALISTE EN INJECTION EXTRUSION PLASTIQUE

QUI SOMMES-NOUS?

CANALPLAST est une société spécialisée depuis plus de 35 ans dans la production et le développement de systèmes de conduits pour installations électriques. L'engagement, la technologie de production, la qualité-produit l'ont amenée à être présente sur les marchés nationaux et internationaux, positionnée parmi les leaders de son secteur. Son réseau d'agents (agences commerciales), ses promoteurs qui interagissent constamment avec les clients et la conception des produits permettent à nos partenaires distributeurs de donner entière satisfaction aux clients finaux.

UNE INFRASTRUCTURE STRATÉGIQUE

Avec une superficie totale de plus de 20.000 m², dont plus de la moitié entièrement couverte, **CANALPLAST** possède un outil industriel de haute technologie avancée, ce qui leur permet de garantir une grande qualité de fabrication testée, vérifiée, emballée et palettisée.

L'usine regroupe les bureaux commerciaux et administratifs, le laboratoire de tests qualité et de contrôle, l'atelier de développement pour la réalisation et l'entretien des moules, l'implantation des machines de production ainsi que le stockage des matières premières. Environ 1500 références sont stockées dans un peu plus de 7500 m². La gestion du stock est entièrement gérée par nos bureaux de coordinations spécialement dédiés aux expéditions et aux enlèvements des marchandises.



WE SAFEGUARD YOUR ENERGY

OLAN produces and sells electrical installation equipment since 1979, with the objective to meet the installation demands, with a range of solutions, articulated in different series of products for different markets. In the course of the years the offer has been enriched with new products in order to offer the market a full and articulated range. From its origin, the company has pursued the goal of quality; in recent years it has invested to expand its design and production facilities, with the aim of achieving better product quality and safety, in compliance with existing standards. The product range growth was performed not only by thinking of the internal market, but mainly of the overseas markets. Product reliability is the fruit of a long experience in the field of plastic molding, this made it possible to continuously improve the production standard. In overseas markets the company is present through importers and agents; now it exports its products to over 50 countries distributed in four continents. All activities are now incorporated within the structures and services provided by Canalplast, thus making the catalog a truly unique and comprehensive proposal.

PRÉSERVONS TON ÉNERGIE

OLAN produit et commercialise des produits de matériel électrique d'installation depuis 1979 ayant pour objectif de répondre aux exigences des installateurs électriciens. Toujours à l'écoute du marché national et international, la gamme **OLAN** n'a cessé de croître d'années en années permettant d'offrir un éventail de produits complémentaires.

Depuis sa création, la société **OLAN** a souhaité persévérer dans le domaine de la qualité de ses produits tout en agrandissant ses projets de production à l'interne: création de nouveaux moules, réalisation de nouveaux produits, qualité maîtrisée, respect des normes et certificats de conformité tant bien pour son marché national qu'international.

Fort de sa longue expérience dans le domaine de l'injection-extrusion plastique, les produits **OLAN** sont désormais représentatifs du marché ELEC. L'intégration définitive des activités de production de **CANALPLAST** et **OLAN** amène une proposition commerciale complète et unique.

SAFETY AND RESISTANCE - SÉCURITÉ ET RÉSISTANCE

TESTED VALUE

Production at **CANALPLAST** is constantly supervised and monitored by technical staff from the Quality Control Department, to guarantee full compliance and conformity to the specific legal requirements and to obtain a high quality product with continuous improvements. The company invests resources, incurring in major expenditures, for the researching and testing materials, for equipment, machinery and the development of new products.



Refrigerator to prepare samples for low temperature shock tests.

Chambre froide pour la climatisation à l'impact des éprouvettes à basse température.



Apparatus for finger-removal and side-segment removal test.

Essais d'équipement et sur le côté du segment retrait de la lame.



Cabin for age acceleration test.

Chambre climatique pour le test de vieillissement accéléré.



Apparatus for testing side walls and lids lowering.

Équipement pour tester les couvercles inférieurs et les parois latérales.



Apparatus for testing heat resistance (850° C) GWT.

Résistance au fil incandescent 850° C.

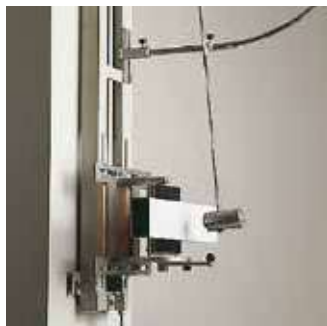

Apparatus for shock testing at room temperature.

Équipement de test de choc à température ambiante.



Apparatus for shock testing at low temperature.

Équipement pour tester l'impact à basse température.



Apparatus for testing heat resistance.

Équipement de test résistance à la chaleur.



Apparatus for insulation resistance above 100 MΩ.

Équipement pour tester la résistance d'isolation de plus de 100 MΩ.



Apparatus for flame propagation resistance test.

Équipement pour essais de résistance à la propagation des flammes.

LA VALEUR TESTÉE

La production **CANALPLAST** est systématiquement prise en charge par notre bureau de contrôle qualité afin d'assurer en permanence la fiabilité de nos produits et la mise en adéquation aux nombreuses normes et certifications Italiennes et internationales. La société investit régulièrement dans la recherche et le développement, notamment pour tout ce qui concerne les essais matériaux, moules, machines et projets de nouveaux produits.

SAFETY AND RESISTANCE - SÉCURITÉ ET RÉSISTANCE

CERTIFIED QUALITY

For us, **quality is not a slogan**, but a term that implies strict adherence to creating a product of the highest quality. IMQ, CSA UL and GOST certifications are an evidence of **CANALPLAST's** quality mission. Since 1991, Canalplast has also received the CSQ, ISO 9001:2008 Certification.



CERTIFICATIONS ET NORMES

La qualité est une priorité pour CANALPLAST. Il en résulte de nos homologations telles que IMQ, CSA, UL, GOST. Notre laboratoire est certifié CSQ, ISO 90001 : 2008 depuis Mai 1991.

A SERVICE ALWAYS ON LINE

CANALPLAST gives prompt answers at any time regarding any information required. **Experts are available** to clarify all possible doubts, give clear-cut explanations and solve any service-related problem.



UN SERVICE TOUJOURS EN LIGNE

CANALPLAST répond toujours rapidement à toutes vos questions. Des experts sont disponibles pour vous donner entière satisfaction.

+39 02 9906421

WWW.CANALPLAST.COM - WWW.OLANSRL.COM

The websites contain **all the most important information, the events** at which Canalplast and Olan participate, new promotions and initiatives, besides as well as the product catalogue. A fast and ultra-convenient means of contacting **Canalplast and Olan in real time**.

Nos sites respectifs vous proposent toutes les informations les plus importantes, les événements et salons à travers lesquels CANALPLAST et OLAN participent ainsi que nos diverses promotions commerciales. Vous y trouverez également notre catalogue en ligne, rapide et efficace pour toutes vos demandes en temps réel.



INDEX/SOMMAIRE

SECTION 1

**INDUSTRIAL WIRE DUCTS
CÂBLAGE INDUSTRIEL 8**

	WIRING DUCTS GOULOTTES DE CÂBLAGE	9
	TRUNKINGS FOR LIFTS GOULOTTES POUR ASCENSORISTES	12
	HALOGEN FREE WIRE DUCTS FOR SWITCHBOARDS GOULOTTES SANS HALOGENES	13
	ACCESSORIES OUTILS	22
	DIN RAILS - ACCESSORIES RAILS DIN MÉTALLIQUE - OUTILS	25

SECTION 2



**INSTALLATION TRUNKINGS
GOULOTTES D'INSTALLATION 28**

	MINI TRUNKINGS AND ACCESSORIES MOULURES ET ACCESSOIRES	29
	TRUNKING SYSTEMS AND ACCESSORIES GOULOTTES ET ACCESSOIRES	31
	"SYS45" QUICK INSTALLATION TRUNKINGS GOULOTTES PORTE-PRISES RAPIDE "SYS45"	35
	DISTRIBUTION BOARD TRUNKINGS GAINES TECHNIQUES DE LOGEMENT (GTI)	37
	CAVITY FLOOR SOCKET BOXES BOÎTES DE SOL	40
	FLOOR SOCKET-POINT TURRETS COLONNES DE BUREAU	43

GENERAL NOTES GENERAL SALES CONDITIONS - SYMBOLS	98
--	----



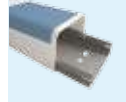



SECTION 3

**AIR CONDITIONING INSTALLATION
GOULOTTES DE CLIMATISATION 44**

	AIR CONDITIONING DUCTS SYSTÈME DE GOULOTTES POUR L'AIR CONDITIONNÉ	45
	CONDENSATION DRAIN ACCESSORIES ACCESSOIRES DE VIDANGE CONDENSATION	48
	BASES AND BRACKETS BASES ET SUPPORTS	50

SECTION 4

**ELECTRICAL EQUIPMENT INSTALLATION
MATÉRIEL ÉLECTRIQUE D'INSTALLATION 52**

	FLUSH JUNCTION BOXES BOÎTES D'ENCASTREMENT	53
	JUNCTION BOXES FOR WALL MOUNTING BOÎTES DE DÉRIVATION	58
	FLUSH AND WALL DISTRIBUTION BOARDS COFFRETS DE DISTRIBUTION	72
	CIRCUIT BREAKERS AND FUSE HOLDERS DISJONCTEURS, BLOCS DIFFÉRENTIELS ET COUPE CIRCUIT	81
	FITTINGS, FASTENINGS, CONNECTORS AND ACCESSORIES MANCHONS, BARRETTES DE CONNEXIONS ET ACCESSOIRES	89
	FISHTAPES AND HOSES CORDONS EXTENSIBLES, TIRE FILS ET OUTILS	97

NOTES GÉNÉRALES CONDITIONS GÉNÉRALES DE VENTE - SYMBOLES	99
--	----

INDEX NEWS/SOMMAIRE DES NOUVELLES

NEWS	PAGE 13	"EHF-P SERIES" HALOGEN FREE WIRE DUCTS GOULOTTES DE CÂBLAGE SANS HALOGÈN "EHF-P"
NEWS	PAGE 13	"EHNH SERIES" HALOGEN FREE WIRE DUCTS GOULOTTES DE CÂBLAGE SANS HALOGÈN "EHNH"
NEWS	PAGE 13	"GHF-P SERIES " HALOGENFREE CABLE TRUNKINGS GOULOTTES DE DISTRIBUTION SANS HALOGEN "GHF-P"
NEWS	PAGE 26	DIN RAIL TO SNAP-ON ELECTRICAL EQUIPMENT PD15Z-PD15ZF4 RAIL DIN EN ACIER POUR ACCROCHAGE DE MATÉRIEL ÉLECTRIQUE PD15Z-PD15ZF4
NEWS	PAGE 27	MANUAL AND PNEUMATIC PROFILE CUTTING TOOL OUTIL MANUEL ET PNEUMATIQUE DE DECOUPE PERFILS
NEWS	PAGE 31	CABLE TRUNKING SYSTEMS "TIPO G" - G50 250X70 GOULOTTES DE DISTRIBUTION STANDARD "TIPO G" - G50 250X70
NEWS	PAGE 45	AIR CONDITIONING TRUNKINGS WITH WRAP-AROUND COVER WITH PROTECTIVE FILM AND ACCESSORIES GOULOTTES ENVELOPPANTE POUR CLIMATISATION AVEC DE FILM DE PROTECTION ET ACCESSORIES
NEWS	PAGE 45	AIR CONDITIONING TRUNKINGS WITH SNAP-ON COVER WITH PROTECTIVE FILM CON65 65X50 -CON80 80X60 AND ACCESSORIES GOULOTTES A DÉCLIC POUR CLIMATISATION AVEC DE FILM DE PROTECTION CON65 65X50 -CON80 80X60 ET ACCESSORIES
NEWS	PAGE 50	BASES AND BRACKETS BASES ET SUPPORTS
NEWS	PAGE 54	FLUSH JUNCTION BOXES (NEW COLORS) BOÎTES D'ENCASTREMENT (NOUVELLES COULEURS)
NEWS	PAGE 61	JUNCTION BOXES FOR WALL MOUNTING (NEW COLORS) BOÎTES DE DÉRIVATION (NOUVELLES COULEURS)
NEWS	PAGE 91	BLACK PG CABLE GLAND PRESSE-ÉTOUPE PG - NOIR



Tailor-made

Now we can!

Ask for our new tailor made service*:
length, color, packaging, punching and kit.

Sur mesure

Maintenant, c'est possible!

Demandez notre nouveau service sur mesure*:
la longueur, la couleur, l'emballage, la perforation
et le kit.

*minimum quantity required/quantité minimale requise

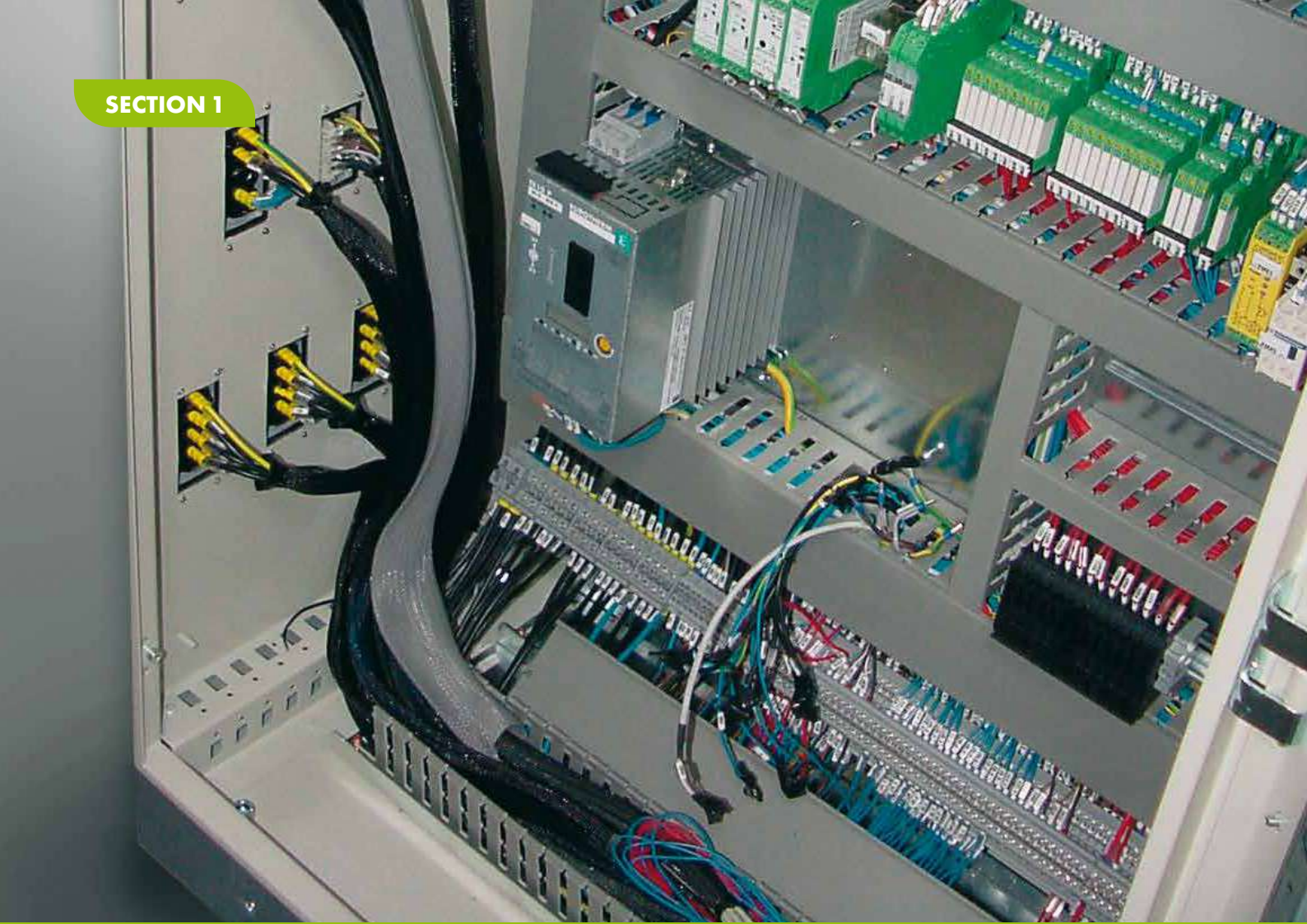

INDUSTRIAL WIRE DUCTS

- ▶ WIRING DUCTS
- ▶ TRUNKINGS FOR LIFTS
- ▶ HALOGEN FREE WIRE DUCTS FOR SWITCHBOARDS
- ▶ ACCESSORIES
- ▶ DIN RAILS

CÂBLAGE INDUSTRIEL

- ▶ GOULOTTES DE CÂBLAGE
- ▶ GOULOTTES POUR ASCENSORISTES
- ▶ GOULOTTES SANS HALOGENES
- ▶ OUTILS
- ▶ RAILS DIN MÉTALLIQUE

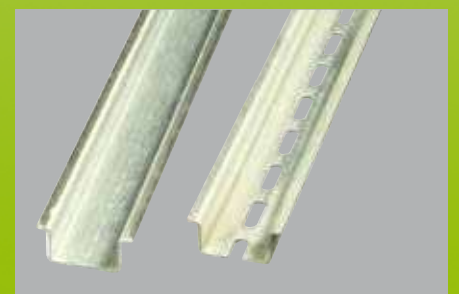

INDUSTRIAL WIRE DUCTS/CÂBLAGE INDUSTRIEL

WIRING DUCTS/GOULOTTES DE CÂBLAGE

"E SERIES" WIRE DUCTS WITH 8mm SLOTS - FINGERS 12mm - LENGTH 2m.
GOULOTTES DE CÂBLAGE "E" - FENTES 8mm - LAMELLES 12mm - LONGUEUR 2m

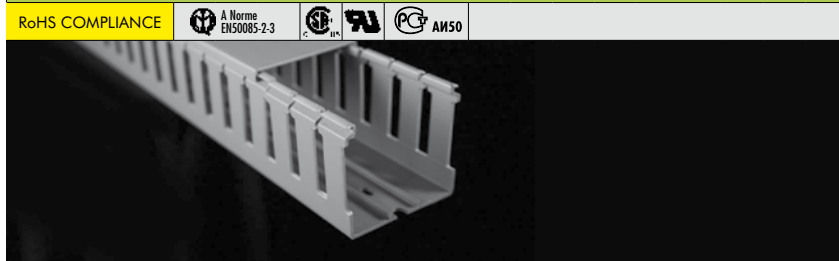

CODE RÉFÉRENCE	BOTTOM SECTION SECTION DU FOND	B mm	H mm	PACK m EMB. m	PACK m³ EMB. m³	PACK Kg EMB. Kg	PALLET m PALLETTEm	TECHNICAL DATA DONNÉES TECH.			
								FIG.	C	D	P
E16	□	25	30	80	0,057	16,0	1600	1	8	12	20
E13			40	60	0,051	15,8	1500	1	8	12	20
E7			60	40	0,051	15,0	1000	1	8	12	20
E14			80	32	0,057	15,6	640	2	8	12	20
E34			100	24	0,057	13,8	480	2	8	12	20
E23	□	40	30	48	0,051	13,5	1200	1	8	12	20
E8			40	40	0,057	14,2	800	1	8	12	20
E5			60	36	0,069	17,8	720	1	8	12	20
E15	□	60	80	24	0,057	14,7	480	2	8	12	20
E35			100	16	0,051	14,1	400	2	8	12	20
E24			30	32	0,051	14,4	800	1	8	12	20
E4	□	80	40	24	0,051	11,4	600	1	8	12	20
E9			60	24	0,069	15,5	480	1	8	12	20
E11			80	24	0,081	18,5	360	2	8	12	20
E18	□	100	100	16	0,074	16,9	320	2	8	12	20
E26			40	24	0,069	14,3	480	1	8	12	20
E6			60	24	0,092	19,2	288	1	8	12	20
E12	□	120	80	24	0,110	21,7	288	2	8	12	20
E36			100	16	0,093	19,8	192	2	8	12	20
E27			40	16	0,057	12,3	320	1	8	12	20
E17	□	150	60	20	0,092	18,7	240	1	8	12	20
E19			80	16	0,092	18,1	192	1	8	12	20
E37			100	16	0,114	21,5	192	2	8	12	20
E43	□	200	150	8	0,085	14,6	120	3	20	30	50
E28			40	20	0,081	18,2	300	1	8	12	20
E10			60	16	0,085	17,5	240	1	8	12	20
E32	□	120	80	16	0,106	20,5	192	2	8	12	20
E38			100	8	0,071	12,6	120	2	8	12	20
E30			60	12	0,081	17,3	180	1	8	12	20
E33	□	150	80	12	0,106	18,9	144	2	8	12	20
E39			100	8	0,081	15,1	120	2	8	12	20
E31	□	200	60	8	0,071	14,6	120	1	8	12	20
E48			80	8	0,092	16,6	96	2	8	12	20
E40			100	8	0,114	18,2	96	2	8	12	20

WIRE DUCTS WITH BOTTOM RAILS - SUPPLIED UPON REQUEST AND FOR QUANTITIES TO BE AGREED
GOULOTTES AVEC GUIDE INTEGRÉE AU FOND - DISPONIBLE SUR DEMANDE ET POUR DES QUANTITÉS A CONVENIR

E5 CG	□	40	60	36	0,069	17,8	720	1	8	12	20
E15 CG			80	24	0,057	14,7	480	2	8	12	20
E4 CG	□	60	40	24	0,051	11,4	600	1	8	12	20
E9 CG			60	24	0,069	15,5	480	1	8	12	20
E11 CG	□	80	80	24	0,081	18,5	360	2	8	12	20
E26 CG			40	24	0,069	14,3	480	1	8	12	20
E6 CG	□	100	60	24	0,092	19,2	288	1	8	12	20
E12 CG			80	24	0,11	21,7	288	2	8	12	20
E17 CG	□	150	60	20	0,092	18,7	240	1	8	12	20
E19 CG			80	16	0,092	18,1	192	1	8	12	20

Colour: Grey RAL 7030/ Couleur: Gris RAL 7030

COVERS/COUVERCLES



CODE RÉFÉRENCE	B mm
GCOP25	25
GCOP40	40
GCOP60	60
GCOP80	80
GCOP100	100
GCOP120	120
GCOP150	150
GCOP200	200

TECHNICAL DATA/DONNÉES TECHNIQUES

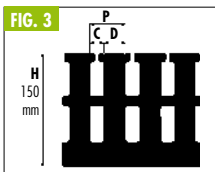
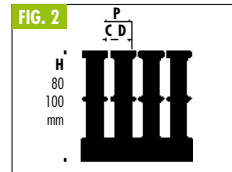
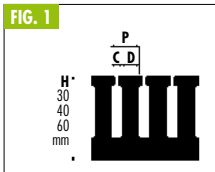

SIZES AND LAYOUT OF HOLES ON THE BOTTOM
DIMENSIONS ET DISPOSITION DES TROUS SUR LE FOND

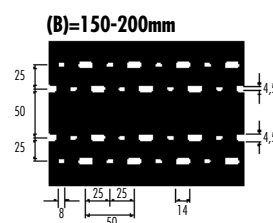
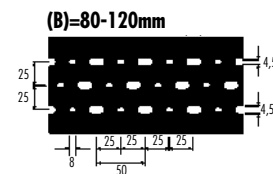
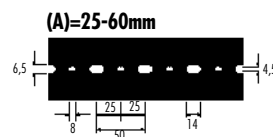

INDUSTRIAL WIRE DUCTS/CÂBLAGE INDUSTRIEL

WIRING DUCTS/GOULOTTES DE CÂBLAGE

"E/4 SERIES" WIRE DUCTS WITH 4mm SLOTS - FINGER 6mm - LENGTH 2m
GOULOTTES DE CÂBLAGE "E/4" - FENTES 4mm - LAMELLES 6mm - LONGUEUR 2m



RoHS COMPLIANCE		À Norme EN50085-2-3		UL		PCB AM50		TECHNICAL DATA DONNÉES TECH.			
CODE RÉFÉRENCE	BOTTOM SECTION SECTION DU FOND	B mm	H mm	PACK m EMB. m	PACK m ³ EMB. m ³	PACK Kg EMB. Kg	PALLET m PALETTE m	FIG.	C	D	P
E20	U	15	17	120	0,036	11,3	3600	1	4	6	10
E22			30	96	0,042	14,1	--	1	4	6	10
E25			40	72	0,042	14,8	2160	1	4	6	10
E164	U	25	30	80	0,057	16	1600	1	4	6	10
E134			40	60	0,051	15,8	1500	1	4	6	10
E74			60	40	0,051	15	1000	1	4	6	10
E144			80	32	0,057	15,6	640	2	4	6	10
E344			100	24	0,057	13,8	480	1	4	6	10
E84	L	40	40	40	0,057	14,2	800	1	4	6	10
E54			60	36	0,069	17,8	720	1	4	6	10
E154			80	24	0,057	14,7	480	2	4	6	10
E354			100	16	0,051	14,1	400	1	4	6	10
E44	L	60	40	24	0,051	11,4	600	1	4	6	10
E94			60	24	0,069	15,5	480	1	4	6	10
E114			80	24	0,081	18,5	360	2	4	6	10
E184			100	16	0,074	16,9	320	1	4	6	10
E264	L	80	40	24	0,069	14,3	480	1	4	6	10
E64			60	24	0,092	19,2	288	1	4	6	10
E124			80	24	0,11	21,7	288	2	4	6	10
E364	L		100	16	0,093	19,8	192	1	4	6	10
E174	L	100	60	20	0,092	18,7	240	1	4	6	10
E194			80	16	0,092	18,1	192	2	4	6	10
E374	L		100	16	0,114	21,5	192	1	4	6	10
E104	L	120	60	16	0,085	17,5	240	1	4	6	10
E324			80	16	0,106	20,5	192	2	4	6	10
E384			100	8	0,071	12,6	120	1	4	6	10
WIRE DUCTS WITH BOTTOM RAILS - SUPPLIED UPON REQUEST AND FOR QUANTITIES TO BE AGREED GOULOTTES AVEC GUIDE INTÉGRÉE AU FOND - DISPONIBLE SUR DEMANDE ET POUR DES QUANTITÉS À CONVENIR											
E54 CG	L	40	60	36	0,069	17,8	720	1	4	6	10
E154 CG			80	24	0,057	14,7	480	2	4	6	10
E44 CG	L	60	40	24	0,051	11,4	600	1	4	6	10
E94 CG			60	24	0,069	15,5	480	1	4	6	10
E114 CG			80	24	0,081	18,5	360	2	4	6	10
E264 CG	L	80	40	24	0,069	14,3	480	1	4	6	10
E64 CG			60	24	0,092	19,2	288	1	4	6	10
E124 CG			80	24	0,11	21,7	288	2	4	6	10
E174 CG	L	100	60	20	0,092	18,7	240	1	4	6	10
E194 CG			80	16	0,092	18,1	192	2	4	6	10

Colour: Grey RAL 7030/ Couleur: Gris RAL 7030

COVERS/COUVERTURES

CODE RÉFÉRENCE	B mm
GCOP15	15
GCOP25	25
GCOP40	40
GCOP60	60
GCOP80	80
GCOP100	100
GCOP120	120
GCOP150	150
GCOP200	200

TECHNICAL DATA/DONNÉES TECHNIQUES

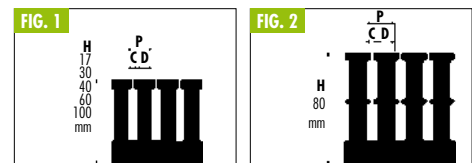
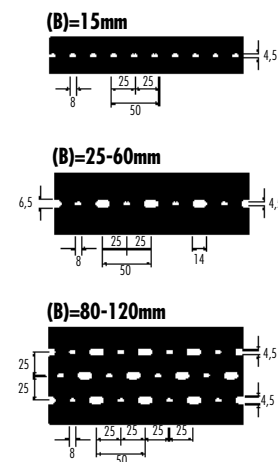
SIZES AND LAYOUT OF HOLES ON THE BOTTOM
DIMENSIONS ET DISPOSITION DES TROUS SUR LE FOND

INDUSTRIAL WIRE DUCTS/CÂBLAGE INDUSTRIEL

WIRING DUCTS/GOULOTTES DE CÂBLAGE

"ED SERIES" WIRE DUCTS WITH 5 mm SLOTS - FINGERS 7,5 mm - LENGTH 2m
GOULOTTES DE CÂBLAGE "ED" - FENTES 5mm - LAMELLES 7,5mm - LONGUEUR 2m

RoHS COMPLIANCE A Norme EN50085-2-3

CODE RÉFÉRENCE	BOTTOM SECTION SECTION DU FOND	B mm	H mm	PACK m EMB. m	PACK m³ EMB. m³	PACK Kg EMB. Kg	PALLET m PALLETTE m	TECHNICAL DATA DONNÉES TECH.			
								FIG.	C	D	P
ED2525		25	25	84	0,051	16,5	2100	1	5	7,5	12,5
ED2537			37,5	64	0,057	15,1	1280	1	5	7,5	12,5
ED2550			50	52	0,057	15,3	1040	1	5	7,5	12,5
ED2575			75	32	0,051	13,1	800	2	5	7,5	12,5
ED3737		37,5	37,5	48	0,057	14,4	960	1	5	7,5	12,5
ED3750			50	32	0,051	11,2	800	1	5	7,5	12,5
ED3775		50	75	32	0,069	15	640	2	5	7,5	12,5
ED5050			50	24	0,051	10,8	600	1	5	7,5	12,5
ED5075		75	75	24	0,069	13,4	480	2	5	7,5	12,5
ED7550			50	24	0,069	13,7	480	1	5	7,5	12,5
ED7575		100	75	16	0,069	11,8	320	2	5	7,5	12,5
ED10050			50	16	0,064	12,2	288	1	5	7,5	12,5
ED10075		125	75	16	0,085	14,1	240	2	5	7,5	12,5
ED12575			75	12	0,085	13,6	180	2	5	7,5	12,5

Colour: Grey RAL 7030/ Couleur: Gris RAL 7030

COVERS/COUVERCLES

CODE RÉFÉRENCE	B mm
GCOP25	25
GCOP37	37,5
GCOP50	50
GCOP75	75
GCOP100	100
GCOP125	125

TECHNICAL DATA/DONNÉES TECHNIQUES

FIG. 1

FIG. 2

SIZES AND LAYOUT OF HOLES ON THE BOTTOM DIMENSIONS ET DISPOSITION DES TROUS SUR LE FOND

(B)=25-50mm

(B)=75-125mm

"EDGE" CORNER WIRE DUCTS FOR ELECTRICAL PANELS
 WITH 4 mm SLOTS - FINGER 6 mm
GOULOTTES ANGULAIRES "EDGE" POUR LES PANNEAUX ELECTRIQUES - FENTES 4mm - LAMELLES 6mm

RoHS COMPLIANCE A Norme EN50085-2-3

CODE RÉFÉRENCE	B mm	H mm	PACK m EMB. m	PACK m³ EMB. m³	PACK Kg EMB. Kg
ED110K40	90	90	8	0,036	12,5
ED110K60	110	110	8	0,036	13,1

Colour: Grey RAL 7030/ Couleur: Gris RAL 7030

INSTALLATION INSTRUCTIONS

Connecting the two slotted walls, 4 mm slots, you have the possibility to use the bottom and side panels for the fixing of instruments and terminals. You can avoid strange applications that, to get the same result, need the fixing of the traditional duct on corner clamps, a solution that restricts the space available for cables.

Fix the corner profile between the panels, with 2-4 rivets (RIV1) or screw per meter (see fig. A). Set the slotted walls under the profile and in the suitable groove. Fix the panel with 2-4 rivets (RIV1) per meter. Fix the cover by pressing. To hold back the wires, use the cross arm TR4-TR6 not supplied.

INSTRUCTIONS DE INSTALLATION

Connectant les deux parois avec fentes de 4 mm sur le fond angle on va exploiter la possibilité d'utiliser les panneaux arrière et latéraux pour le positionnement des instruments et des bornes (morsetti, clamps). Cela réduit les applications étranges qui, pour atteindre le même but, exigent la fixation de la goulotte traditionnelle sur des consoles angulaires : une solution cependant qui limite l'espace disponible pour les câbles.

Fixer le profil angulaire entre les deux panneaux et / ou les poutres du cadre, avec 2-4 rivets (riv1) ou des boulons par mètre (voir fig. A). Encastrer les parois fentées sous la pièce angulaire dans les rainures appropriées. Fixer au cabinet avec 2-4 rivets (riv1) par mètre. Encliqueter le couvercle. Pour la tenue des câbles, utilisez la traverse tr6-tr4 non fournie.

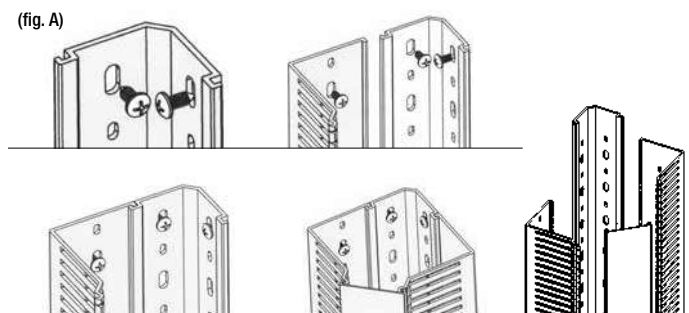

THE "SERIES EDGE" is a CANALPLAST WORLDWIDE PATENT
 La "SÉRIE EDGE" est un BREVET MONDIAL CANALPLAST

TECHNICAL DATA/ DONNÉES TECHNIQUES

Space optimization for cables. Optimisation de l'espace pour câbles.

Traditional system wastes space. Système traditionnel avec perte d'espace.

INDUSTRIAL WIRE DUCTS/CÂBLAGE INDUSTRIEL

TRUNKINGS FOR LIFTS/GOULOTTES POUR ASCENSORISTES



LIFT TRUNKINGS - COLOUR: DARK GREY. LENGTH 2m
GOULOTTES POUR ASCENSORISTES - COULEUR: GRIS FONCÉ - LONGUEUR 2m



EN-50085-2-1



CODE RÉFÉRENCE	BOTTOM SECTION SECTION DU FOND	B mm	H mm	PACK m EMB. m	PACK m ³ EMB. m ³	PACK Kg EMB. Kg	S. G. mm ²
AS G8		40	40	40	0,057	16	1310
AS G4		60	40	24	0,051	13	1960
AS G9			60	24	0,069	18	3080
AS G26		80	40	24	0,069	15,8	2665
AS G6			60	24	0,092	22	4175
AS G17		100	60	20	0,092	21	5295
AS G19			80	16	0,092	21,2	7215
AS G10		120	60	16	0,085	19,3	6390
AS G32			80	16	0,106	23,1	8710
AS G33		150	80	12	0,106	21,2	10770

SPECIAL LIFT TRUNKINGS WITH PRE-PUNCHED HOLES COLOUR: DARK GREY. LENGTH 2m
GOULOTTES POUR ASCENSORISTES POUR DÉRIVER TUBES ET TUYAUX
 COULEUR: GRIS FONCÉ - LONGUEUR 2m



EN-50085-2-1

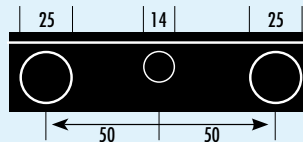

CODE RÉFÉRENCE	BOTTOM SECTION SECTION DU FOND	B mm	H mm	PACK m EMB. m	PACK m ³ EMB. m ³	PACK Kg EMB. Kg	S. G. mm ²
AS G8P		40	40	40	0,057	16	1310
AS G4P		60	40	24	0,051	12,9	1960
AS G26P			80	24	0,069	15,4	2665

SPECIAL LIFT TRUNKINGS WITH PRE-PUNCHED SLOTS COLOUR: GREY. LENGTH 2m
GOULOTTES POUR ASCENSORISTES SPÉCIALE PRÉ-PERFORÉE COULEUR: GRIS - LONGUEUR 2m

EN-50085-2-1

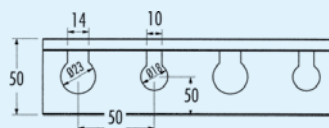

CODE RÉFÉRENCE	BOTTOM SECTION SECTION DU FOND	B mm	H mm	PACK m EMB. m	PACK m ³ EMB. m ³	PACK Kg EMB. Kg	S. G. mm ²
G055P		50	50	24	0,051	12,7	2126
G075P		75	50	24	0,069	16,3	3115
G105P			100	16	0,064	14,6	4270

INDUSTRIAL WIRE DUCTS/CÂBLAGE INDUSTRIEL

HALOGEN FREE WIRE DUCTS FOR SWITCHBOARDS/GOULOTTES SANS HALOGENES



"EHF-P SERIES" HALOGEN FREE WIRE DUCTS

WITH 5mm SLOTS - FINGER 7,5 mm - COLOUR: LIGHT GREY - LENGTH 2m
 GOULOTTES DE CÂBLAGE SANS HALOGENES "EHF-P"
 FENTES 5mm - LAMELLES 7,5mm - COULEUR: GRIS CLAIR - LONGUEUR 2m

RoHS COMPLIANCE EN 50085-2-3 CEI EN 50267-2-1 EN 45545-2 EN ISO 4589-2 NFX 70-100

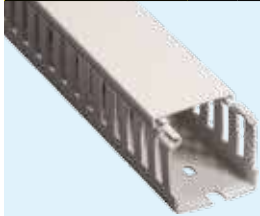

CODE RÉFÉRENCE	BOTTOM SECTION SECTION DU FOND	B mm	H mm	PACK m EMB. m	PACK m ³ EMB. m ³	PACK Kg EMB. Kg	PALLET m PALLETTE m	TECHNICAL DATA DONNÉES TECH.			
								FIG.	C	D	P
EHF-P2525		25	25	84	0,051	16,5	2100	1	5	7,5	12,5
EHF-P2537			37,5	64	0,057	15,1	1280	1	5	7,5	12,5
EHF-P2550			50	52	0,057	15,3	1040	1	5	7,5	12,5
EHF-P2575			75	32	0,051	13,1	800	2	5	7,5	12,5
EHF-P3737		37,5	37,5	48	0,057	14,4	960	1	5	7,5	12,5
EHF-P3750			50	32	0,051	11,2	800	1	5	7,5	12,5
EHF-P3775		75	32	0,069	15	640	2	5	7,5	12,5	
EHF-P5050		50	50	24	0,051	10,8	600	1	5	7,5	12,5
EHF-P5075			75	24	0,069	13,4	480	2	5	7,5	12,5
EHF-P7550		75	50	24	0,069	13,7	480	1	5	7,5	12,5
EHF-P7575			75	16	0,069	11,8	320	2	5	7,5	12,5
EHF-P10050		100	50	16	0,064	12,2	288	1	5	7,5	12,5
EHF-P10075			75	16	0,085	14,1	240	2	5	7,5	12,5
EHF-P12575		125	75	12	0,085	13,6	180	2	5	7,5	12,5

Items supplied upon request and for quantities be agreed also without slots./Articles fournis sur demande et pour des quantités convenues sans fentes.

"EHNH SERIES" HALOGEN FREE WIRE DUCTS

WITH 5mm SLOTS - FINGER 7,5 mm - COLOUR: DARK GREY - LENGTH 2m
 GOULOTTES DE CÂBLAGE SANS HALOGENES "EHNH"
 FENTES 5mm - LAMELLES 7,5mm - COULEUR: GRIS FONCÉ - LONGUEUR 2m

RoHS COMPLIANCE EN 50085-2-3 CEI EN 50267-2-1 EN 45545-2 EN ISO 4589-2 NFX 70-100



CODE RÉFÉRENCE	BOTTOM SECTION SECTION DU FOND	B mm	H mm	PACK m EMB. m	PACK m ³ EMB. m ³	PACK Kg EMB. Kg	PALLET m PALLETTE m	TECHNICAL DATA DONNÉES TECH.			
								FIG.	C	D	P
EHNH2525		25	25	84	0,051	12,2	2100	1	5	7,5	12,5
EHNH2537			37,5	64	0,057	12,5	1280	1	5	7,5	12,5
EHNH2550			50	52	0,057	12,7	1040	1	5	7,5	12,5
EHNH2575			75	32	0,051	13,1	800	2	5	7,5	12,5
EHNH3737		37,5	37,5	48	0,057	14,3	960	1	5	7,5	12,5
EHNH3750			50	32	0,051	11,1	800	1	5	7,5	12,5
EHNH3775		75	32	0,069	14,9	640	2	5	7,5	12,5	
EHNH5050		50	50	24	0,051	8,2	600	1	5	7,5	12,5
EHNH5075			75	24	0,069	13,4	480	2	5	7,5	12,5
EHNH7550		75	50	24	0,069	13,7	480	1	5	7,5	12,5
EHNH7575			75	16	0,069	11,8	320	2	5	7,5	12,5
EHNH10050		100	50	16	0,064	12,2	288	1	5	7,5	12,5
EHNH10075			75	16	0,085	14,1	240	2	5	7,5	12,5
EHNH12575		125	75	12	0,085	10,9	180	2	5	7,5	12,5

Items supplied upon request and for quantities be agreed
 Articles fournis sur demande et pour des quantités convenues.

COVERS/COUVERCLES

CODE RÉFÉRENCE	B mm
HF-PCOP25	25
HF-PCOP37	37,5
HF-PCOP50	50
HF-PCOP75	75
HF-PCOP100	100
HF-PCOP125	125

TECHNICAL DATA/DONNÉES TECHNIQUES

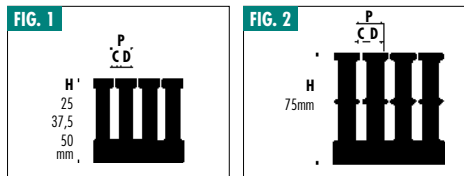

SIZES AND LAYOUT OF HOLES ON THE BOTTOM
 DIMENSIONS ET DISPOSITION DES TROUS SUR LE FOND

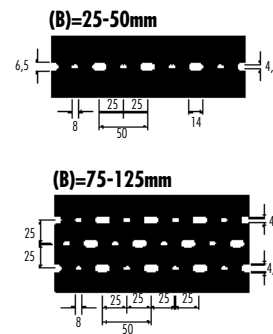

COVERS/COUVERCLES

CODE RÉFÉRENCE	B mm
HNCOP25	25
HNCOP37	37,5
HNCOP50	50
HNCOP75	75
HNCOP100	100
HNCOP125	125

GHF-P SERIES " HALOGEN
FREE CABLE TRUNKINGS
GOULOTTES DE DISTRIBUTION
SANS HALOGEN GHF-P

Items supplied upon request and for quantities be agreed
 Articles fournis sur demande et pour des quantités convenues.

INDUSTRIAL WIRE DUCTS/CÂBLAGE INDUSTRIEL

TECHNICAL DATA/CARACTÉRISTIQUES TECHNIQUES

WIRE FILL CAPACITY CHART/TABLEAU DE CAPACITE DE REMPLISSAGE DE FIL

TRUNKING DIMENSION GOULOTTE DIMENSION B x H mm		ELECTRICAL WIRES/FILS ÉLECTRIQUES													COMMUNICATION					
		H07V-U/R/K			8 AWG	10 AWG	12 AWG		14 AWG			16 AWG		18 AWG		22 AWG	24 AWG			
		mm ²			.216	.153	.122	.158	.105	.139	.165	.096	.125	.084	.113	.065	.217	.250	.422	
			1	1,5	2,5	THHN	THHN	THHN	MTW	THHN	MTW	MTW	TFFN	MTW	TFFN	MTW	MTW	UTP/CM Cat5e	STP/CM Cat6e	UPT/CM
15 x 17	170	16	12	8	4	7	10	7	14	10	6	18	11	24	13	40	4	3	1	
15 x 30	320	30	22	15	7	12	20	14	27	18	12	34	20	45	25	75	7	5	2	
25 x 30	550	52	38	26	12	21	34	24	46	31	20	59	35	77	43	129	12	9	3	
40 x 30	920	87	63	44	20	35	56	40	76	52	33	98	58	129	71	215	19	15	5	
60 x 30	1400	132	96	67	31	54	85	60	116	79	51	150	88	197	108	328	29	22	8	
15 x 40	450	42	31	22	10	17	27	19	37	26	16	48	28	63	35	105	9	7	2	
25 x 40	760	72	52	36	17	29	46	33	63	43	28	81	48	107	59	178	16	12	4	
40 x 40	1310	123	90	63	29	50	80	57	109	74	48	140	83	184	101	306	27	21	7	
60 x 40	1960	185	134	94	43	75	120	85	163	111	71	210	124	275	152	459	41	31	11	
80 x 40	2655	250	182	127	58	102	162	115	220	151	96	284	168	373	205	621	56	42	15	
100 x 40	3375	318	231	161	74	130	206	146	280	192	122	361	213	474	261	790	71	53	19	
120 x 40	4070	383	279	195	89	156	248	176	338	231	148	435	257	571	315	952	85	64	23	
25 x 60	1200	113	82	57	26	46	73	52	100	68	44	128	76	168	93	281	25	19	7	
40 x 60	1960	185	134	94	43	75	120	85	163	111	71	210	124	275	152	459	41	31	11	
60 x 60	3080	290	211	147	68	118	188	133	256	175	112	330	194	432	238	721	65	49	17	
80 x 60	4175	393	286	200	92	161	255	180	347	237	151	447	264	586	323	977	88	66	23	
100 x 60	5295	499	363	253	116	204	323	229	440	301	192	566	334	743	409	1239	111	84	29	
120 x 60	6390	602	438	306	140	246	390	276	530	363	232	684	403	897	494	1495	134	101	35	
150 x 60	8070	760	553	386	177	310	493	349	670	458	293	863	510	1133	624	1888	169	127	45	
200 x 60	10820	1019	741	517	237	416	661	467	898	614	393	1158	683	1519	837	2531	227	171	60	
25 x 80	1540	145	105	74	34	59	94	67	128	87	56	165	97	216	119	360	32	24	9	
40 x 80	2680	253	183	128	59	103	164	116	222	152	97	287	169	376	207	627	56	42	15	
60 x 80	4200	396	288	201	92	161	256	181	349	238	152	449	265	590	325	983	88	66	23	
80 x 80	5695	537	390	272	125	219	348	246	473	323	207	609	360	800	440	1332	119	90	32	
100 x 80	7215	680	494	345	158	277	440	312	599	409	262	772	456	1013	558	1688	151	114	40	
120 x 80	8710	821	596	416	191	335	532	376	723	494	316	932	550	1223	674	2038	183	138	48	
150 x 80	10770	1015	737	515	236	414	658	465	894	611	391	1152	680	1512	833	2520	226	170	60	
200 x 80	14470	1363	991	692	317	556	883	625	1201	821	525	1548	914	2031	1119	3385	304	229	80	
25 x 100	2310	218	158	110	51	89	141	100	192	131	84	247	146	324	179	540	48	36	13	
40 x 100	3350	316	229	160	73	129	205	145	278	190	122	358	212	470	259	784	70	53	19	
60 x 100	5320	501	364	254	117	205	325	230	442	302	193	569	336	747	411	1245	112	84	29	
80 x 100	7125	671	488	341	156	274	435	308	591	404	258	762	450	1000	551	1667	149	113	39	
100 x 100	9135	861	625	437	200	351	558	395	758	518	331	977	577	1282	706	2137	192	144	51	
120 x 100	10820	1019	741	517	237	416	661	467	898	614	393	1158	683	1519	837	2531	227	171	60	
150 x 100	13670	1288	936	654	300	526	835	590	1135	776	496	1462	863	1919	1057	3198	287	216	76	
200 x 100	18370	1731	1258	878	403	706	1122	794	1525	1043	666	1965	1160	2579	1421	4298	385	290	102	
100 x 150	13695	1290	938	655	300	527	836	592	1137	777	497	1465	865	1923	1059	3204	287	216	76	
25 x 25	440	41	30	21	10	17	27	19	37	25	16	47	28	62	34	103	9	7	2	
25 x 37,5	720	68	49	34	16	28	44	31	60	41	26	77	45	101	56	168	15	11	4	
25 x 50	985	93	67	47	22	38	60	43	82	56	36	105	62	138	76	230	21	16	5	
25 x 75	1485	140	102	71	33	57	91	64	123	84	54	159	94	208	115	347	31	23	8	
37,5 x 37,5	1125	106	77	54	25	43	69	49	93	64	41	120	71	158	87	263	24	18	6	
37,5 x 50	1560	147	107	75	34	60	95	67	129	89	57	167	99	219	121	365	33	25	9	
37,5 x 75	2370	223	162	113	52	91	145	102	197	135	86	254	150	333	183	554	50	37	13	
50 x 50	2090	197	143	100	46	80	128	90	173	119	76	224	132	293	162	489	44	33	12	
50 x 75	3220	303	220	154	71	124	197	139	267	183	117	344	203	452	249	753	68	51	18	
75 x 50	3200	302	219	153	70	123	195	138	266	182	116	342	202	449	247	749	67	51	18	
75 x 75	4930	465	338	236	108	190	301	213	409	280	179	527	311	692	381	1153	103	78	27	
100 x 50	5000	471	342	239	110	192	305	216	415	284	181	535	316	702	387	1170	105	79	28	
100 x 75	6630	625	454	317	145	255	405	286	550	376	241	709	419	931	513	1551	139	105	37	
125 x 75	7115	670	487	340	156	274	434	307	591	404	258	761	449	999	550	1665	149	112	39	
90 x 90	8100	763	555	387	178	311	495	350	672	460	294	867	511	1137	626	1895	170	128	45	
110 x 110	11020	1038	755	527	242	424	673	476	915	625	400	1179	696	1547	852	2578	231	174	61	

INDUSTRIAL WIRE DUCTS/CÂBLAGE INDUSTRIEL

TECHNICAL DATA/CARACTÉRISTIQUES TECHNIQUES

BOTTOM RAILS/RAILS

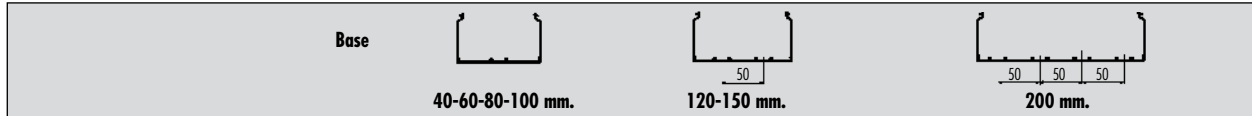

Sizes and layout of the bottom rails for separators use.

The wiring duct is fastened to the wall by TS plugs, 2/4 per meter for the smaller sizes, 4/8 per meter for the larger sizes.

Dimension et disposition du fond pour le positionnement des séparateurs de goulotte. La goulotte se fixe avec une cheville TS, 2/4 par mètre pour les petites sections, 4/8 pour les sections les plus importantes.

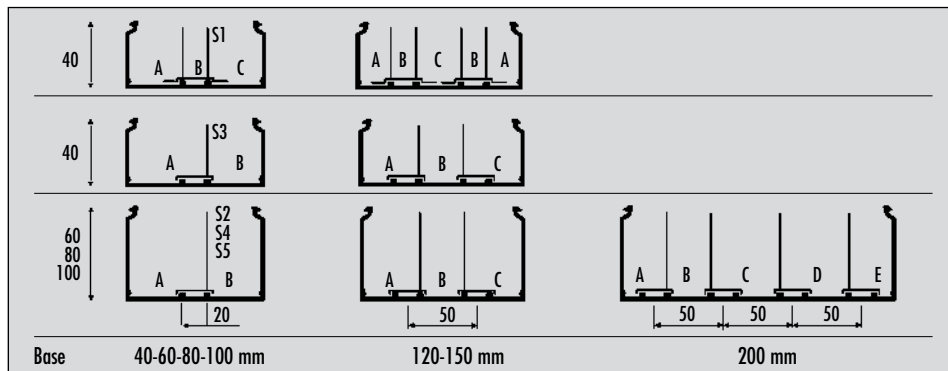

Use of the S separators.
Compartments section in mm²
Utilisation de séparateurs S.
Section de compartiments en mm²

Wiring duct sizes <i>Dimension goulotte</i>	N°compartments <i>S1</i>	Section				
		A	B	C	D	E
mm.		mm ²	mm ²	mm ²		
60 x 40	3	680	425	680	-	-
80 x 40	3	1030	425	1030	-	-
100 x 40	3	1387	425	1387	-	-
120 x 40	3 - 5	805	425	875		
	S2 / S3 / S4 / S5					
60 x 40	2	1223	737	-	-	-
80 x 40	2	1565	1090	-	-	-
100 x 40	2	1930	1445	-	-	-
120 x 40	3	1387	1295	1387	-	-
60 x 60	2	2060	1020	-	-	-
80 x 60	2	2607	1567	-	-	-
100 x 60	2	3167	2127	-	-	-
120 x 60	3	2170	2035	2170	-	-
150 x 60	3	3015	2035	3015	-	-
200 x 60	5	1750	2035	2640	2640	1750
60 x 80	2	2820	1380	-	-	-
80 x 80	2	3567	2127	-	-	-
100 x 80	2	4327	2887	-	-	-
120 x 80	3	2965	2775	2965	-	-
150 x 80	3	3995	2775	3995	-	-
200 x 80	5	2247	2775	3600	3600	2247
100 x 100	2	5487	3647	-	-	-
120 x 100	3	3705	3404	3705	-	-
150 x 100	3	5130	3404	5130	-	-
200 x 100	5	3065	3404	4416	4416	3065

CLASSIFICATION INDEX ACCORDING TO THE STANDARD EN 50085-2/3

INDICES DE CLASSIFICATION DES SECONDES NORMES EN 50085-2/3

Reference to the specifications for slotted and solid trunkings for installation inside of electrical panels.

Référence aux prescriptions pour goulottes de cablage destinées à l'installation à l'intérieur des tableaux électriques.

Classification min. temperature of transport and storage <i>Classification température minimale de transport et stockage</i>			Classification min. temperature of installation and use <i>Classification température minimale de installation et utilisation</i>			Classification max temp. of use <i>Classification température maximale de utilisation</i>		
1 st Code	Temp. C°	Temp. F°	2 nd Code	Temp. C°	Temp. F°	3 rd Code	Temp. C°	Temp. F°
1xx	-45	-49	x1x	-25	-13	xx1	+60	140
2xx	-25	-13	x2x	-15	5	xx2	+90	194
3xx	-5	23	x3x	-5	23	xx3	+105	221
			x4x	+5	41	xx4	+120	248
			x5x	+15	59			

Derivating classification of our wire ducts
Classification qui en résulte pour nos goulottes.

ECABL		ALOFREE	
Tipo E	231	Tipo EHF-P	113
Tipo E/4	231	Tipo EHNH	114
Tipo EDGE	231		

INDUSTRIAL WIRE DUCTS/CÂBLAGE INDUSTRIEL

TESTS OF FLAMMABILITY, QUALITY AND RESISTANCE REFERRED TO ELECTRICAL SYSTEMS

Test on printout

Flammability tests.	IEC 695-2-2	Description: the test simulates the effect of small flames caused by faulty conditions inside electrical equipment. The test piece is subjected to a 12.7 mm long flame produced by a burner whose nozzle has a diameter of 0.5 mm. Propagation of the flame is tested by placing under the specimen a layer of material of the components which in reality surround the part and a sheet of tissue paper. Evaluation: the duration of combustion is less than 30" and the flame does not propagate to the underlying material. Classification: pass/fail.
	UL 94 Vertical positioning (standard in force in the USA)	Description: the test simulates the effect of small flames caused by faulty conditions inside electrical equipment. The test piece is subjected to a 12.7 mm long flame produced by a nozzle with diameter of 9.5 mm. The flame is applied for 10", repeating this for a further 10" after extinguishing of the fire. Propagation of the flame is tested by placing dry cotton wool under the specimen. Evaluation: the duration of combustion is less than the set time and there are few drips of flamed material. Classification: V0: combustion stops within 10" without flame propagation. V1: combustion stops within 30" without flame propagation. V2: combustion stops within 30" with flame propagation.
	IEC 695-2-1 (Glow Wire)	Description: this test simulates the thermal stresses produced by heat or ignition sources such as overloaded resistors or glowing metal elements. The specimen is clamped for 30" with the force of 1 Newton against the tip of a glowing metal wire with specified temperatures (750, 850, 950°C). A sheet of paper and board are placed under the specimen. Evaluation: extinguishing of the flame and ceasing of glowing within 30" from removal of the wire, no ignition of the paper and no scorching on the board. Classification: pass/fail.
	CSE RF 1/75/A	Description: the test gives an approximate indication of the reaction to fire of a material during the initial phase of a fire. The flame, 40 mm high, is applied on both faces of a vertical specimen, on the lower edge. Evaluation: various parameters are considered and set, according to specified formulae: post-combustion time, post-glowing time, damaged area, dripping. Classification: on the basis of the calculation procedures categories I, II, III, IV are assigned in decreasing order of safety.
Fire reaction class.	CSE RF1 CSE RF3	Description: combination of the classifications CSE RF 1 and CSE RF 3. Classification: six classes are defined: 0 (non-combustible material), 1, 2, 3, 4, and 5, through the combination of the categories obtained from the two tests.
Characterisation of fumes.	CEI 20-37 Part 2	Description: the presence of a certain number of substances in fumes generated by the product at a temperature of 80°C is gauged. The substances measured are: carbon dioxide, carbon monoxide, hydrochloric acid, hydrobromic acid, hydrofluoric acid, hydrocyanic acid, sulphur dioxide, hydrogen sulphide, nitrogen oxides (NO+NO ₂), ammonia, acrylonitrile, formaldehyde. Evaluation: according to a predefined formula, a toxicity rating is obtained (from 0 onwards) from the quantities of all the substances measured. Classification: according to the rating. (ENEL, the Italian electricity board, for example, sets 5 as maximum acceptability and the Italian navy 2.5).

Tests on material

Heat resistance.	CEI 23-8	Description: the temperature at which the material, under load, starts to soften, is measured. A test piece of a pipe cut longitudinally is brought to a temperature of 90°C. A steel ball, 5 mm in diameter, is pressed against the inner surface of the test piece with a force of 20 Newton. After 1 hour the ball is removed. Evaluation: the diameter of the imprint left by the ball on the surface, measured cold, must not be more than 2 mm. Classification: pass/fail.
Flame resistance.	CEI 23-8	Description: the resistance to the prolonged action of a flame is measured. The test consists in subjecting a piece of pipe to the action of a 100 mm flame (energy produced: 775 Kcal/h) slanting 45° upwards for 1 minute. The test is repeated three times. Evaluation: after this time, if the test piece burns through self-combustion, the flames must extinguish within 30". Classification: pass/fail.
Compressive strength.	CEI 23-8	Description: the pipe test piece is subjected to compression of 750 Newton for 1 minute. The variation in the external diameter, before and after removal of the force, is measured. Evaluation: the diameter must not exceed the original one by 25% with the force still applied, and by 20% after the force has been removed. The test pieces must not crack. Classification: pass/fail.
Impact resistance.	CEI 23-8	Description: the test piece, after being kept for 10 days in an oven at 60°C, is brought to the temperature of -25°C and then subjected to impact through the falling of a hammer, whose weight varies according to the diameter, from a height of 20 cm. Evaluation: the test pieces must not show fractures or cracks. Classification: pass/fail.
Dielectric resistance.	CEI 23-8	Description: a test to determine the degree of insulation, performed in two phases. The U-bent pipe is immersed, except for its ends, in water at a temperature of 20°C and filled with water. After 24 hours' immersion, a voltage of 2000V ac is applied to two electrodes, one inside the pipe the other in the receptacle, at a frequency of 50Hz, for 15 minutes. The same pipe is immersed in water at 60°C and after two hours the electrical resistance is measured, applying a continuous voltage of 500V. Evaluation: 1) there must be no perforations of the pipe. 2) the insulation resistance must not be below 100 MΩ. Classification: pass/fail.

INDUSTRIAL WIRE DUCTS/CÂBLAGE INDUSTRIEL

TECHNICAL DATA

MATERIALS' TECHNICAL PROPERTIES

	STANDARDS		MEASUREMENT UNIT	EHNH	EHF-P	PVC	ABS
MECHANICAL PROPERTIES							
TENSILE STRENGTH TO YIELD POINT	ASTM D 638	DIN 53455	MPa	64	-	46,2	-
ULTIMATE TENSILE STRENGTH	ASTM D 638	DIN 53455	MPa	53	60	37,3	40
ELONGATION TO YIELD POINT	ASTM D 638	DIN 53455	%	-	-	-	25
ULTIMATE ELONGATION	ASTM D 638	DIN 53455	%	20	>50	-	-
TENSILE MODULUS	ASTM D 638	DIN 53457	MPa	-	2500	-	-
FLEXURAL STRENGTH TO YIELD POINT	ASTM D 790	DIN 53452	MPa	100	-	-	-
FLEXURAL MODULUS	ASTM D 790	DIN 53457	MPa	-	-	2736	2400
HARDNESS H358/30	-	DIN 53456	MPa	-	-	-	-
ROCKWELL HARDNESS	ASTM D 758	-	-	-	-	-	-
SHORE HARDNESS	-	-	-	-	-	79 D	110 R
IMPACT RESISTANCE							
CHARPY TEST, WITH NOTCH	ISO 179/1eA	DIN 53453	KJ/m ²	20	-	-	-
IZOD TEST, WITH NOTCH, AT 23°C	ASTM D 256	-	J/m	300	-	74	70
IZOD TEST, WITH NOTCH, AT 0°C	-	-	-	-	-	41	40
IZOD TEST, WITH NOTCH, AT -10°C	-	-	-	-	-	4	5
IZOD TEST, WITH NOTCH, AT -30°C	-	-	J/m	181	-	-	-
IZOD TEST, WITH NOTCH, AT -40°C	ASTM D 256	-	J/m	-	-	-	-
THERMAL PROPERTIES							
SOFTENING TEMPERATURE, VICAT METHOD B	ASTM D 1525	-	°C	143	130	-	-
VICAT VST/B/120	-	DIN 53460	°C	-	-	76	95
DEFORM. TEMPERATURE UNDER LOAD, 1,82 MPa	ASTM D 648	DIN 53461	°C	122	-	-	-
THERMAL CONDUCTIVITY	ASTM C 117	-	W/m°C	-	-	-	-
COEFFICIENT OF LINEAR THERMAL EXPANSION	ASTM D 696	VDE 0304/1	m/m°C	-	-	0,1	0,19
PHYSICAL PROPERTIES							
PHYSICAL PROPERTIES	ASTM D 792	DIN 53479	g/cm ³	1,11	1,19	1,55	1,05
WATER ABSORPTION, 24 HOURS	ASTM D 570	-	%	-	0,15	-	-
WATER ABSORPTION AT EQUILIBRIUM	ASTM D 570	-	%	-	-	-	-
WATER ABSORPTION AT EQUILIBRIUM AT 100°C	ASTM D 570	-	%	-	-	-	-
ELECTRICAL PROPERTIES							
VOLUME RESISTIVITY	ASTM D 257	-	Ohm-m	>762	-	-	-
INSTANTANEOUS DIELECTRIC RIGIDITY, IN OIL, 3,2 mm	ASTM D 149	IEC 60243-1	Kv/mm	34,1	-	-	-
DIELECTRIC CONSTANT AT 50 Hz	ASTM D 150	-	-	-	-	-	-
DIELECTRIC CONSTANT AT 1 MHz	ASTM D 150	IEC 60250	-	2,7	-	-	-
DISSIPATION FACTOR AT 50 Hz	ASTM D 150	-	-	-	-	-	-
DISSIPATION FACTOR AT 1 MHz	ASTM D 150	IEC 60250	-	0,0029	-	-	-
FLAME RESISTANCE							
OXYGEN INDEX (LOI)	ISO 4589	-	%	33	28	-	-
SELF-EXTINGUISHING (mm of thickness)	UL 94	-	-	V-0 (1,5)	V-0 (1,6)	V-0	V-2
OPTICAL DENSITY, 90 sec.	ASTM E 662	-	-	-	80	-	-
4 min	ASTM E 662	-	-	30	-	-	-

Typicals values. Data for guidance purposes only.

CHEMICAL RESISTANCE OF NORYL

CHEMICALS	CLASS	CHEMICALS	CLASS	CHEMICALS	CLASS
Ethyl acetate	C	Alcalis	A	Aromatic hydrocarbons	C
Acetone	C	Ethyl alcohol	C	Chlorinated hydrocarbons	C
Mineral acids (diluted)	A	Isopropyl alcohol	C	Potassium hydroxide 50%	A
Mineral acids (concentrated)	B	Methyl alcohol	A	Sodium hydroxide 50%	A
Acetic Acid 90%	--	Antifreeze	C	Transmission fluid	C
Hydrochloric Acid 37%	--	Petrol	B-C	Methacrylate sealant	C
Phosphoric Acid 60%	A	Ketones	C	White mineral oil	--
Nitric Acid 90%	--	Greases and oil	B	Detergent solutions	A
Sulphuric Acid 98%	--	Aliphatic hydrocarbons	B	Solvents/Alcohols	A

LEGEND: CLASS **A** = resistant; CLASS **B** = limited resistance; CLASS **C** = not resistant; -- = not tested.

INDUSTRIAL WIRE DUCTS/CÂBLAGE INDUSTRIEL

TESTS D'INFLAMMABILITÉ, QUALITÉ ET RÉSISTANCE SE RÉFÉRANT AUX SYSTÈMES ÉLECTRIQUES

TESTS SUR LE PRODUIT

Tests d'inflammabilité.

IEC 695-2-2

Description: Le test simule l'effet de petites flammes causées par des conditions défectueuses à l'intérieur de l'équipement électrique. La pièce est soumise à une flamme de 12 mm de long d'un brûleur dont la buse a un diamètre de 0,5 mm. La propagation de la flamme est contrôlée en plaçant l'échantillon dans une couche de matériau des composants qui, en réalité, autour de la pièce à usiner et une feuille de papier de soie.

Évaluation: la durée de combustion est inférieure à 30 "et il n'y a pas de propagation de la flamme sur le matériau sous-jacent ».

Classification: passe / ne passe pas.

UL 94

Position verticale
(Norme en vigueur
aux États-Unis)

Description: Le test simule l'effet de petites flammes causées par des conditions défectueuses à l'intérieur de l'équipement électrique. La pièce est soumise à une flamme longue 12,7 mm à partir d'un diamètre de buse de 9,5 mm. L'application de la flamme dure 10 "et est répétée pour un autre 10" après l'extinction de l'incendie. La flamme se produit en plaçant l'échantillon dans un coton sec.

Évaluation: la durée de combustion est inférieure à la période pré-établie et se détache moins gouttes de matière brûlante.

Classification:

VO: la combustion s'arrête à 10" et il n'y a pas de propagation de la flamme.

V1: la combustion s'arrête dans les 30" et il n'y a pas de propagation de la flamme.

V2: arrête de brûler moins de 30" et la propagation des flammes.

IEC 695-2-1

(Fil incandescent)

Description: Ce test simule les contraintes thermiques des sources de chaleur ou d'inflammation tels que des résistances surchargées ou métal chaud. L'échantillon est pressé pour 30" avec une force de 1 Newton sur le bout d'un fil métallique incandescent avec des températures prédéterminées (750, 850, 950 ° C). Au-dessous de l'échantillon sont placés un carton et une feuille de papier.

Évaluation: extinction et terminaison d'incandescence avant de 30" de l'enlèvement du fil, pas d'inflammation du papier et absence de brûlures sur la boîte en carton.

Classification: passe / ne passe pas.

CSE RF 1/75/A

Description: Le test donne une indication générale de la réaction au feu d'un matériel dans la première phase de l'incendie. La flamme, 40 mm de haut, est appliquée sur les deux faces d'un spécimen vertical, sur le bord inférieur.

Évaluation: Différents paramètres sont examinés et composés selon des formules préétablies: le temps de postcombustion, le temps de post-décharge, la zone endommagée, l'égouttement.

Classification: Basée sur les méthodes de calcul les catégories I, II, III, IV sont attribuées par ordre décroissant de la sécurité.

Réaction au feu.

CSE RF1

CSE RF3

Description: est une combinaison de classifications CST et CSE RF 3 RF 1.

Classification: six classes sont définies: 0 (matériaux non combustibles), 1, 2, 3, 4, 5, grâce à la combinaison des catégories issues des deux essais.

Caractérisation des fumées.

CEI 20-37

Partie 2

Description: La mesure de la présence d'un certain nombre de substances dans les gaz de combustion développés par le produit à une température de 80 ° C. Substances détectées sont: le dioxyde de carbone, monoxyde de carbone, l'acide chlorhydrique, l'acide bromhydrique, l'acide fluorhydrique, l'acide cyanhydrique, le dioxyde de soufre, sulfure d'hydrogène, des oxydes d'azote (NO + NO 2), l'ammoniac, l'acrylonitrile, le Formica formaldéhyde.

Évaluation: selon une formule prédéterminée il résulte un indice de toxicité (de 0 au dessus) des quantités détectées de toutes les substances.

Classification: selon l'indice.

TESTS SUR LE MATERIEL

Résistance à la chaleur.

CEI 23-8

Description: on mesure la température à laquelle un matériel commence à ramollir. Une pièce d'essai de tube est découpé longitudinalement et porté à une température de 90 ° C. Sur la surface intérieure de l'échantillon on presse une bille en acier de 5 mm de diamètre, avec une force de 20 Newton. Après 1 heure la bille est enlevée.

Évaluation: Le diamètre de l'empreinte laissée par la bille sur la surface, mesurée à froid, ne doit pas être majeure de 2 mm.

Classification: passe / ne passe pas.

Résistance à la flamme.

CEI 23-8

Description: mesure de la résistance à l'action prolongée de la flamme. Le test est réalisé par un échantillon soumis à l'action d'une flamme de longueur de 100 mm (énergie produite égale à 775 Kcal / h) inclinée à 45 ° vers le haut, pendant 1 minute. Le test est répété trois fois.

Évaluation: Après ce délai, si l'échantillon continue à brûler, les flammes doivent s'éteindre dans un délai de moins de 30".

Classification: passe / ne passe pas.

Résistance à la compression.

CEI 23-8

Description: L'échantillon est soumis à une force de compression de 750 Newton pour 1 minute. On fait la mesure du diamètre extérieur, après et avant l'application de la force.

Évaluation: Le diamètre ne doit pas dépasser l'original du 25% avec la force appliquée et du 20% après que la force a été éliminée. Les échantillons doivent être sans fissures.

Classification: passe / ne passe pas.

Résistance aux chocs.

CEI 23-8

Description: L'échantillon, après avoir été maintenu pendant 10 jours dans une étuve à 60° C, est porté à une température de -25° C et il est soumis ensuite à un choc par chute d'un marteau, dont la masse varie selon le diamètre, d'une hauteur de 20 cm.

Évaluation: Les échantillons ne doivent pas présenter des fractures ni des fissures.

Classification: passe / ne passe pas.

Rigidité diélectrique.

CEI 23-8

Description: C'est un test pour déterminer le degré d'isolement, réalisée en deux phases. L'échantillon en forme de tube recourbé en U est immergé, à l'exception des extrémités, dans l'eau à une température de 20° C et remplie d'eau lui-même. Après 24 heures d'immersion, à deux des électrodes placés l'un à l'intérieur du tube, l'autre dans le bassin, lui est appliquée une tension de 2000 VAC, 50 Hz, pendant 15 minutes. Le même tube est enfin immergé dans l'eau à 60° C et l'après deux heures la résistance électrique est mesurée en appliquant une tension continue de 500 V.

Évaluation: 1) Aucune perforation du tube doit être notée. 2) La résistance d'isolement ne doit pas être inférieure à 100 MΩ.

Classification: passe / ne passe pas.

INDUSTRIAL WIRE DUCTS/CÂBLAGE INDUSTRIEL

CARACTÉRISTIQUES TECHNIQUES

CARACTÉRISTIQUES TECHNIQUES DES MATÉRIAUX

	NORMES		UNITÉ DE MESURE	EHNH	EHF-P	PVC	ABS
CARACTÉRISTIQUES MÉCANIQUES							
RÉSISTANCE À LA TRACTION AU SEUIL D'ÉCOULEMENT	ASTM D 638	DIN 53455	MPA	64	-	46,2	-
RÉSISTANCE À LA RUPTURE	ASTM D 638	DIN 53455	MPA	53	60	37,3	40
ALLONGEMENT AU SEUIL D'ÉCOULEMENT	ASTM D 638	DIN 53455	%	-	-	-	25
ALLONGEMENT À LA RUPTURE	ASTM D 638	DIN 53455	%	20	>50	-	-
MODULE DE TRACTION	ASTM D 638	DIN 53457	MPA	-	2500	-	-
RÉSISTANCE À LA FLEXION À RENDEMENT	ASTM D 790	DIN 53452	MPA	100	-	-	-
MODULE À LA FLEXION	ASTM D 790	DIN 53457	MPA	-	-	2736	2400
DURETÉ H358/30	-	DIN 53456	MPA	-	-	-	-
DURETÉ ROCKWELL	ASTM D 758	-	-	-	-	-	-
DURETÉ SHORE	-	-	-	-	-	79 D	110 R
RÉSISTANCE AU CHOC							
TEST CHARPY, AVEC CRANTÉE	ISO 179/1EA	DIN 53453	KJ/M2	20	-	-	-
TEST IZOD, AVEC CRANTÉE À 23°	ASTM D 256	-	J/M	300	-	74	70
TEST IZOD, AVEC CRANTÉE À 0°	-	-	J/M	-	-	41	40
TEST IZOD, AVEC CRANTÉE À -10°	-	-	J/M	-	-	4	5
TEST IZOD, AVEC CRANTÉE À -30°	-	-	J/M	181	-	-	-
TEST IZOD, AVEC CRANTÉE À -40°C	ASTM D 256	-	J/M	-	-	-	-
PROPRIÉTÉS THERMIQUES							
TEMPÉRATURE DE RAMOLLISSEMENT VICAT, MÉTHODE B	ASTM D 1525	-	°C	143	130	-	-
VICAT VST/B/120	-	DIN 53460	°C	-	-	76	95
TEMP. DE DÉFORMATION SOUS CHARGE, 1,82 MPA	ASTM D 648	DIN 53461	-	122	-	-	-
CONDUCTIVITÉ THERMIQUE	ASTM C 117	-	W/M°C	-	-	-	-
COEFFICIENT DE DILATATION THERMIQUE LINÉAIRE	ASTM D 696	VDE 0304/1	M/M°C	-	-	0,1	0,19
PROPRIÉTÉS PHYSIQUES							
POIDS SPÉCIFIQUE	ASTM D 792	DIN 53479	g/cm³	1,11	1,19	1,55	1,05
ABSORPTION D'EAU, 24 HEURES	ASTM D 570	-	%	-	0,15	-	-
ABSORPTION D'EAU À L'ÉQUILIBRE	ASTM D 570	-	%	-	-	-	-
ABSORPTION D'EAU À L'ÉQUILIBRE À 100°C	ASTM D 570	-	%	-	-	-	-
PROPRIÉTÉS ÉLECTRIQUES							
RÉSISTIVITÉ VOLUMIQUE	ASTM D 257	-	OHM-M	>762	-	-	-
INSTANTANÉE RIGIDITÉ DIÉLECTRIQUE, DANS L'HUILE, 3,2 MM	IEC 60243-1	-	KV/MM	34,1	-	-	-
CONSTANTE DIÉLECTRIQUE À 50 HZ	ASTM D 150	-	-	-	-	-	-
CONSTANTE DIÉLECTRIQUE À 1 MHZ	IEC 60250	-	-	2,7	-	-	-
FACTEUR DE DISSIPATION À 50 HZ	ASTM D 150	-	-	-	-	-	-
FACTEUR DE DISSIPATION À 1 MHZ	IEC 60250	-	-	0,0009	-	-	-
COMPORTEMENT AU FEU							
INDICE D'OXYGÈNE	ASTM D 2863	-	%	33	28	-	-
AUTO-EXTINGUIBLE (ÉPAISSEUR EN MM)	UL 94	-	-	V-0 (1,5)	V-0 (1,6)	V-0	V-2
DENSITÉ OPTIQUE, 90 SEC.	ASTM E 662	-	-	-	80	-	-
4 MINUTES	ASTM E 662	-	-	30	-	-	-

Données uniquement à des fins d'orientation.

RÉSISTANCE CHIMIQUE DU NORYL

PRODUITS CHIMIQUES	CLASS	PRODUITS CHIMIQUES	CLASS	PRODUITS CHIMIQUES	CLASS
Acétate d'éthyle	C	Alcali	A	Hydrocarbures aromatiques	C
Acétone	C	Alcool éthylique	C	Hydrocarbures chlorés	C
Minéraux acides (faible)	A	Alcool isopropylique	C	Hydroxyde de potassium à 50%	A
Minéraux acides (forts)	B	Alcool méthylique	A	Hydroxyde de sodium à 50%	A
Acide acétique à 90%	--	Antigel	C	Liquide de transmission	C
Acide chlorhydrique à 37%	--	Pétrol	B-C	Mastic acrylique	C
Acide phosphorique 60%	A	Cétones	C	Huile minérale	--
Acide nitrique 90%	--	Graisses et huiles	B	Solutions de nettoyage	A
Acide sulfurique 98%	--	Hydrocarbures aliphatiques	B	Solvants/alcools	A

LÉGENDE: CLASS **A** = résistant; CLASS **B** = résistance limitée; CLASSE **C** = pas résistant; -- = pas testé.

INDUSTRIAL WIRE DUCTS/CÂBLAGE INDUSTRIEL

TECHNICAL DATA

PVC RESISTANCE TO CHEMICAL AGENTS

CHEMICAL COMPOUND	CONCENTRATION	TEMP. ° C	RESISTANCE OF PVC	CHEMICAL COMPOUND	CONCENTRATION	TEMP. ° C	RESISTANCE OF PVC
LEAD ACETATE, solution	hot saturated	50	+	CALCIUM CHLORIDE, solution	dilute	40	+
VINEGAR (wine)	commercially available	40	+	IRON CHLORIDE, solution	up to 10%	40	+
ACETONE	trace	20	-	HEXANE	-	20	+
ACETONE	100%	20	-	ETHYL BENZOL	-	20	-
FATTY ACIDS	100%	60	+	FORMALDEHYDE	dilute	40	+
ARSENIC ACID, solution	dilute	40	+	FREON 12	100%	20	+
BENZOLIC ACID, solution	any concentration	20	+	OIL, heating	-	20	•
BORIC ACID, solution	dilute	40	+	GELATINE, solution	all concentrations and types	40	+
BUTYRIC ACID, solution	20%	20	+	GLYCERINE, solution	all concentrations and types	60	+
CITRIC ACID, solution	up to 10%	40	+	HYDROGEN	100%	60	+
HYDROCHLORIC ACID, solution	up to 30%	40	+	BARIUM HYDROXIDE, solution	all concentrations and types	60	+
CHROMIC ACID, solution	up to 50%	40	+	POTASSIUM HYDROXIDE, solution	up to 40%	40	+
FORMIC ACID	100%	20	+	SODIUM HYDROXIDE, solution	up to 40%	40	+
FORMIC ACID, solution	up to 50%	40	+	MILK	commercially available	20	+
NITRIC ACID, solution	up to 30%	50	+	LIQUID ANTIFREEZE, for motor vehicles	commercially available	20	+
BATTERY ACID	-	60	+	LYE	-	-	-
PRUSSIC ACID	-	60	+	MOLASSES	industrial concentrate	20	+
SILICIC ACID, solution	all concentrations and types	60	+	PETROL/BENZOL MIXTURE	80/20%	20	-
SULPHURIC ACID, solution	up to 40%	40	+	NAPHTHALENE	-	20	-
SUCCINIC ACID, solution	-	60	+	NEKTAL BX, solution	dilute	40	+
TANNIC ACID	10%	60	•	OILS AND GREASES	commercially available	60	+
TARTARIC ACID, solution	up to 10%	40	+	LUBRICATING OILS	100%	20	+
WATER	100%	40	+	CAMPHOR OIL	100%	20	+
AMMONIA WATER	hot saturated	40	+	DIESEL OIL	100%	20	+
BROMINE WATER	cold saturated	20	+	CORNFLOWER OIL	-	20	+
CHLORINE WATER	saturated	20	•	LINSEED OIL	100%	60	•
SEA WATER	-	60	•	MANDARIN OIL	-	20	+
WHITE SPIRIT	-	20	•	MINERAL OIL	100%	20	+
SALT WATER	-	40	+	SILICONE OIL	100%	20	+
CARBONATED WATER	normal	40	•	TURPENTINE OIL	100%	60	•
AQUA VITAE, all types	commercially available	20	+	TRANSFORMER OIL	100%	20	+
DENATURED ETHYL ALCOHOL (sol. 2%)	96%	20	+	LIQUID PARAFFIN	100%	20	-
METHYL ALCOHOL	100%	40	+	OZONE	100%	20	+
AMMONIA GAS	100%	60	+	PARAFFIN	-	60	+
LIQUID AMMONIA	100%	20	•	POTASSIUM PERMANGANATE	up to 6%	20	+
CARBON DIOXIDE dry	100%	60	+	LIQUID PROPANE	100%	20	+
PURE ANILINE	100%	20	-	COOKING SALT, solution	dilute	40	+
PHOTOGRAPHIC DEVELOPMENT BATHS	commercially available	40	+	BARIUM SALTS, solution	all concentrations	60	+
PETROL	100%	60	+	FERTILIZER SALTS, solution	up to 10%	60	+
PETROL for tests	-	20	+	ZINC SALTS, solution	cold diluted	60	+
BENZOL	100%	20	-	SODIUM CARBONATE, solution	dilute	40	+
ALCOHOLIC DRINKS	commercially available	20	+	ALUMINIUM SULPHATE, solution	dilute	40	+
BEER	commercially available	20	+	COPPER SULPHATE, solution	dilute	40	+
BORAX, solution	dilute	40	+	ZINC SULPHATE, solution	dilute	40	+
BROMINE, liquid	100%	20	-	SOLUTION for photographic laboratories	commercially available	40	+
BUTADIENE	50%	60	+	FRUIT JUICES	usual concentration	60	+
BUTANE, gas	-	20	+	CARBON TETRACHLORIDE technical	100%	20	•
BUTANOL	up to 10%	20	+	TETRAETHYL LEAD	100%	20	+
BEESWAX	commercially available	20	+	TETRAHYDROFURAN	100%	20	-
CHLORINE active	usual concentration	40	+	TINCTURE OF IODINE	commercially available	20	-
CHLORINE GAS, dry	100%	20	+	TOLUENE	100%	20	-
CHLORINE GAS, wet	0,5%	20	+	UREA, solution	up to 10%	40	-
LIQUID CHLORINE	-	20	-	URINE	normal	40	+
ALUMINIUM CHLORIDE, solution	dilute	40	+	WINES, red and white	commercially available	20	+
CALCIUM CHLORIDE, aqueous (sedim.)	-	60	•	SULPHUR	-	60	•

Legend: + Resistant - Not resistant • Limited resistance

FLAME RESISTANCE

Italian Ministry of Interiors Approval
Cod. M1422C30CD100001
File 4190, sub. 326 - Material prototype: G30

PVC: Class M1 (NFP 92-501)
Self-extinguishing (UL94 VO) for trunking
GWT 850° for accessories

INDUSTRIAL WIRE DUCTS/CÂBLAGE INDUSTRIEL

CARACTÉRISTIQUES TECHNIQUES

RÉSISTANCE CHIMIQUE DU PVC

COMPOSÉ CHIMIQUE	CONCENTRATION	TEMP. ° C	RÉSISTANCE DU PVC	COMPOSÉ CHIMIQUE	CONCENTRATION	TEMP. ° C	RÉSISTANCE DU PVC
ACÉTATE de plomb, solution	chaude saturée	50	+	CHLORURE DE CALCIUM, solution	dilué	40	+
VINAIGRE (de vin)	commercialisé	40	+	CHLORURE DE FER, solution	jusqu'à 10%	40	+
ACÉTONE	traces	20	- -	HEXANE	-	20	+
ACÉTONE	100%	20	- -	ÉTHYLBENZÈNE	-	20	-
ACIDES GRAS	100%	60	+	FORMALDÉHYDE	dilué	40	+
ACIDE ARSÉNIQUE, solution	dilué	40	+	FREON 12	100%	20	+
ACIDE BENZOÏQUE, solution	tous	20	+	HUILE, pour le chauffage	-	20	•
ACIDE BORIQUE, solution	dilué	40	+	GÉLATINE, solution	tous	40	+
ACIDE BUTYRIQUE, solution	20%	20	+	GLYCÉRINE, solution	tous	60	+
ACIDE CITRIQUE, solution	jusqu'à 10%	40	+	HYDROGÈNE	100%	60	+
ACIDE CHLORHYDRIQUE, solution	jusqu'à 30%	40	+	HYDROXYDE DE BARYUM, solution	tous	60	+
ACIDE CHROMIQUE, solution	jusqu'à 50%	40	+	HYDROXYDE DE POTASSIUM, solution	jusqu'à 40%	40	+
ACIDE FORMIQUE	100%	20	+	HYDROXYDE DE SODIUM, solution	jusqu'à 40%	40	+
ACIDE FORMIQUE, solution	jusqu'à 50%	40	+	LAIT	commercialisé	20	+
ACIDE NITRIQUE, solution	jusqu'à 30%	50	+	ANTIGEL pour voitures	commercialisé	20	+
ACIDE pour accumulateur	-	60	+	LESSIVE	-	-	-
ACIDE PRUSSIQUE	-	60	+	MÉLASSE	industriel	20	+
ACIDE SILICIQUE, solution	tous	60	+	MÉLANGE ESSENCE/BENZÈNE	80/20%	20	-
ACIDE SULFURIQUE, solution	jusqu'à 40%	40	+	NAPHTALÈNE	-	20	-
ACIDE SUCCINIQUE, solution	-	60	+	NEKTAL BX, solution	dilué	40	+
ACIDE TANNIQUE	10%	60	•	HUILES ET GRAISSES	commercialisé	60	+
ACIDE TARTRIQUE, solution	jusqu'à 10%	40	+	HUILES LUBRIFIANTES	100%	20	+
EAU	100%	40	+	HUILE DE CAMPHRE	100%	20	+
EAU D'AMMONIAC	chaude saturée	40	+	GASOIL	100%	20	+
EAU BROMIQUE	froide saturée	20	+	HUILE DE FLEURS DE MAÏS	-	20	+
EAU DE CHLORE	saturée	20	•	HUILE DE LIN	100%	60	•
EAU DE MER	-	60	•	HUILE DE MANDARINE	-	20	+
ESSENCE DE TÉRÉBENTHINE	-	20	•	HUILE MINÉRALE	100%	20	+
EAU SALÉE	-	40	+	HUILE DE SILICONE	100%	20	+
EAU GAZEUSE	normal	40	•	TÉRÉBENTHINE HUILE	100%	60	•
SPIRITUEUX, de tous les types	commercialisé	20	+	HUILE POUR TRANSFORMATEUR	100%	20	+
ALCOOL ÉTHYLIQUE DÉNATURÉ (sol. 2%)	96%	20	+	HUILE DE VASELINE	100%	20	-
ALCOOL MÉTHYLIQUE	100%	40	+	OZONE	100%	20	+
GAZ AMMONIAC	100%	60	+	PARAFFINE	-	60	+
AMMONIAQUE LIQUIDE	100%	20	•	PERMANGANATE DE POTASSIUM	jusqu'à 6%	20	+
DIOXYDE DE CARBONE sec	100%	60	+	PROPANE LIQUIDE	100%	20	+
PURE ANILINE	100%	20	- -	SEL DE CUISINE, solution	dilué	40	+
BAINS de développement photographique	commercialisé	40	+	SELS DE BARYUM, solution	tous	60	+
ESSENCE	100%	60	+	SELS D'ENGRAIS, solution	jusqu'à 10%	60	+
ESSENCE pour test	-	20	+	SELS DE ZINC, solution	dilué à froid	60	+
BENZÈNE	100%	20	- -	SODA, solution	dilué	40	+
BOISSONS ALCOOLIQUES	commercialisé	20	+	SULFATE D'ALUMINIUM, solution	dilué	40	+
BIÈRE	commercialisé	20	+	SULFATE DE CUIVRE, solution	dilué	40	+
BORAX, solution	dilué	40	+	SULFATE DE ZINC, solution	dilué	40	+
BROME, liquide	100%	20	- -	SOLUTION pour les laboratoires photo	commercialisé	40	+
BUTADIÈNE	50%	60	+	JUS DE FRUITS	concentration de l'utilisation	60	+
BUTANE, gazeux	-	20	+	TÉTRACHLORURE DE CARBONE technique	100%	20	•
BUTANOL	jusqu'à 10%	20	+	TÉTRAETHYLENE DE PLOMB	100%	20	+
CIRE D'ABEILLE	commercialisé	20	+	TETRAHYDROFURAN	100%	20	-
CHLORE actif	concentration de l'utilisation	40	+	TEINTURE D'IODE	commercialisé	20	-
CHLORE GAZEUX, à sec	100%	20	+	TOLUÈNE	100%	20	-
CHLORE GAZEUX, humide	0,5%	20	+	URÉE, solution	jusqu'à 10%	40	-
CHLORE LIQUIDE	-	20	- -	URINE	normal	40	+
CHLORURE D'ALUMINIUM, solution	dilué	40	+	VINS, rouge et blanc	commercialisé	20	+
CHLORURE DE CHAUX, aqueuse (sédiments)	-	60	•	SOUFRE	-	60	•

Légende: + Résistant - Non résistant • Résistance limitée

CLASSIFICATION RÉACTION AU FEU

Approbation - Ministère de l'Intérieur
 Ref. M1422C30CD100001
 Fichier 4190, signature 326 - Matériel Prototype: G30

PVC: Catégorie M1 (NFP 92-501)
 auto-extinguible (UL94 VO) pour goulottes
 GWT 850° pour les accessoires

INDUSTRIAL WIRE DUCTS/CÂBLAGE INDUSTRIEL

ACCESSORIES/OUTILS

"CP" SPIRAL
SPIRALE "CP"

HALOGEN FREE / SANS HALOGENS



CODE RÉFÉRENCE	Ø mm		MAX ELASTICITY OF TUBING MAX ÉLASTICITÉ DU TUBE Ø MM	COLOUR COULEUR	PACK m EMB. m
	A	B			
CP3	1,5	3	2-12	T	400 (8x50)
CP6	4,2	6	5-50	T	200 (8x25)
CP8	6,0	8	8-70	T	100 (4x25)
CP10	7,6	10	12-100	T	100 (4x25)
CP12	9,6	12	14-120	T	100 (4x25)
CP14	11,6	14	18-140	T	60 (3x20)
CPA3	1,5	3	2-12	A	400 (8x50)
CPA6	4,2	6	5-50	A	200 (8x25)
CPA10	7,6	10	12-100	A	100 (4x25)
CPA12	9,6	12	14-120	A	100 (4x25)
CPN3	1,5	3	2-12		400 (8x50)
CPN6	4,2	6	5-50		200 (8x25)
CPN8	6,0	8	8-70		100 (4x25)
CPN10	7,6	10	12-100		100 (4x25)
CPN12	9,6	12	14-120		100 (4x25)

T = Transparent

A = White self-extinguishing V2 / Blanc auto-extinguible V2

= Black not self-extinguishing / Noir non auto-extinguible

"FLX" FLEXIBLE DUCTS TO GATHER THE CABLES

WITH ADHESIVE ON THE BOTTOM. MATERIAL: POLYPROPYLENE
GOULOTTES FLEXIBLE POUR REGROUPER LES CÂBLES
AVEC ADHÉSIF AU FOND. MATÉRIEL: POLYPROPYLÈNE

RoHS COMPLIANCE

-15°/+80°

SELF-EXTINGUISHING UL94-V2

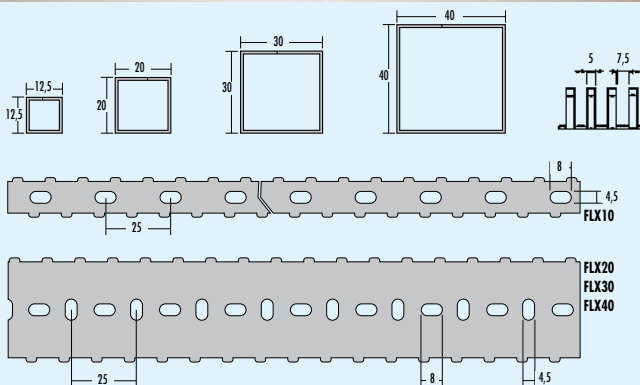

CODE RÉFÉRENCE	B	H	L	COLOUR COULEUR	PACK Pcs. EMB. Pcs.
FLX10	12,5	12,5	500		50
FLX20	20	20	500		50
FLX30	30	30	500		50
FLX40	40	40	500		50

"GUEST" EXTENSIBLE STOCKING SHEATHS
GAINES TRESSÉES EXTENSIBLES "GUEST"

RoHS COMPLIANCE

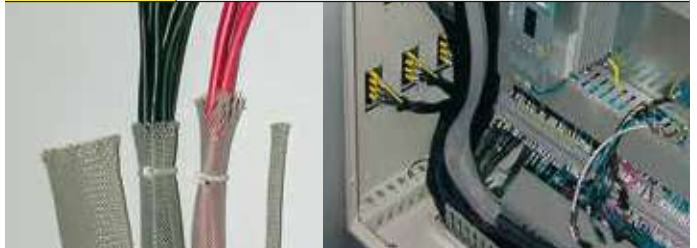

CODE RÉFÉRENCE	Ø mm	COLOUR COULEUR	PACK m EMB. m
GUEST 05	5 10		200
GUEST 10	10 18		200
GUEST 20	20 30		100
GUEST 30	30 45		100
GUEST 50	50 75		50

Suitable for flexible electrical wire and cables, the extensible sheath protects the wires from abrasion and improves the thermal and electrical isolation. The GUEST sheath allows pulling wires out off the mesh at different locations.

Convient pour les câbles électriques flexibles, la gaine facilite la protection extensible contre l'abrasion et améliore l'isolation thermique et électrique. Vous permet de gagner les faisceaux de câbles avec des diamètres très différents, permettant l'évacuation des fils individuels à travers les boucles écartées.

Matériau: Polyester Monofilament

SPECIFICATIONS

Non-toxic
Resistant to abrasive and combustible substances, liquids, solvents, moulds
Excellent resistance to abrasion
Diameter of polyester yarn 0,22 mm
Working temperature -50°/+150°C
Max continuous working temperature +120°C
Max peak temperature +180°C

Flammability rating UL94 HB
Oxygen index LO1 27,5
Melting point 257°C
Softening point 230° - 240°C
Water absorption in normal climate conditions 0,4%
Water absorption and saturation 0,5 - 0,6%
Max elongation at break 23 - 28%
Water contraction at 100° CX3 2 - 10%

INFORMATIONS TECHNIQUES

Aucune toxicité
Résistance à abrasif, des liquides inflammables, solvants, les moisissures
Excellente résistance à l'abrasion
0,22 mm de fils de polyester de diamètre
Gamme de température -50°/+150 °C
Température maximale d'utilisation en continu +120 °C
La température max 180 °C dans l'utilisation alternée

Inflammabilité Auto-extinguible UL94 HB
Indice d'oxygène 27,5 LO1
257 Point de fusion °C
Point de ramollissement 230° - 240 °C
Absorption d'eau 0,40% dans le climat norme
L'absorption d'eau et saturation de 0,5 à 0,6%
Allongement à la rupture max 23 à 28%
Pick-H₂O à 100 °C CX3 2 à 10%

"SPIFAST" SHEATH AND TOOL/GAINE ET OUTIL "SPIFAST"

MATERIAL: POLYPROPYLENE / MATÉRIEL: POLYPROPYLÈNE

HALOGEN FREE / SANS HALOGENS

-20°/+90°

UL94-HB

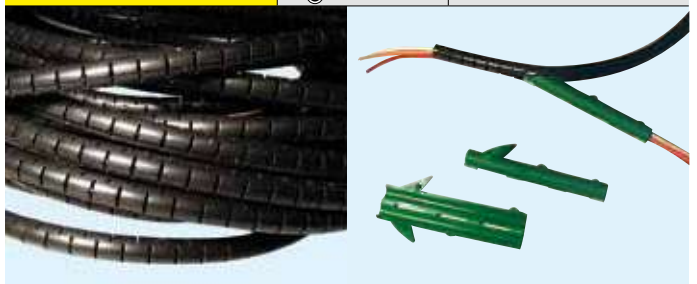

CODE RÉFÉRENCE	DESCRIPTION DESCRIPTION	Ø mm	CABLES 1x2,5 MAX	COLOUR COULEUR	PACK m EMB. m	PACK Pcs. EMB. Pcs.
SPF08N	Sheath/Gaine	8	6		100	
SPF15N	Sheath/Gaine	15	10		50	
SPF20N	Sheath/Gaine	20	14		30	
SPF25N	Sheath/Gaine	25	14		20	
SPFUT08	Tool/Outil	8	-	-	10	
SPFUT15	Tool/Outil	15	-	-	10	
SPFUT20	Tool/Outil	20	-	-	10	
SPFUT25	Tool/Outil	25	-	-	5	

INDUSTRIAL WIRE DUCTS/CÂBLAGE INDUSTRIEL

ACCESSORIES/OUTILS

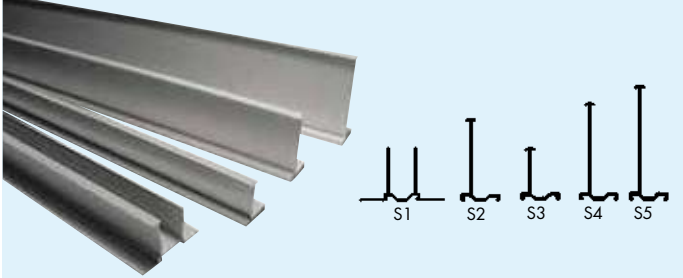
CABLE SEPARATORS
SÉPARATEURS DE CABLESRoHS COMPLIANCE 

CODE RÉFÉRENCE	H	PACK m EMB. m
S1 (2 Separators/2 Séparateurs)	40	30
S2	60	50
S3	40	60
S4	80	32
S5	100	32

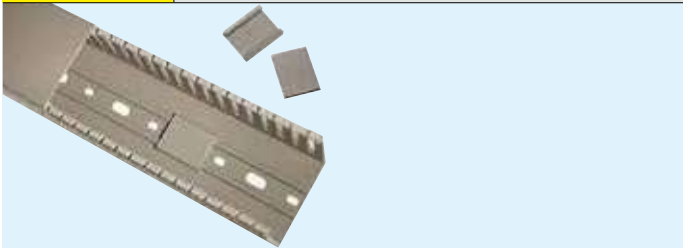
COVERS TO INSTALL OVER IF METAL SCREWS ARE USED TO SECURE THE DUCT
MINI COUVERCLES POUR ISOLER LES VIS DE FIXATION EN MÉTALRoHS COMPLIANCE 

CODE RÉFÉRENCE	PACK Pcs. EMB. Pcs.
COVIT	1000

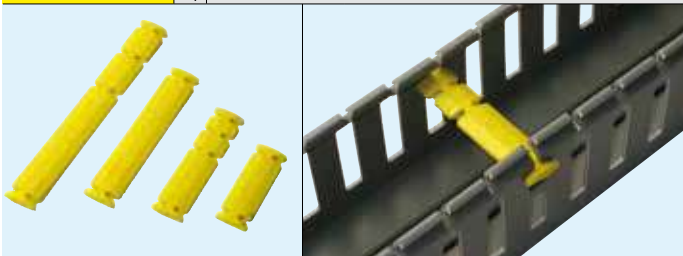
CROSS-ARMS TO RETAIN THE CABLES WHEN THE COVER IS REMOVED
TRAVERSES POUR CONTENIR LES FILS ÉLECTRIQUES DANS LES GOULOTTESRoHS COMPLIANCE 

CODE RÉFÉRENCE	FOR TRUNKING B POUR GOULOTTE B	PACK Pcs. EMB. Pcs.
TR4	40	500 (5x100)
TR6	60	500 (5x100)
TR8	80	400 (5x80)
TR10	100/120	250 (5x50)
TR15	125	200 (1x200)

CROSS-ARM FOR TRUNKINGS
TRAVERSE POUR LES GOULOTTESRoHS COMPLIANCE 

CODE RÉFÉRENCE	PACK Pcs. EMB. Pcs.
PTR	100 (4x25)

CABLE-RETAINING CROSS-ARMS

TRAVERSES POUR CONTENIR LES FILS ÉLECTRIQUES DANS LES GOULOTTES

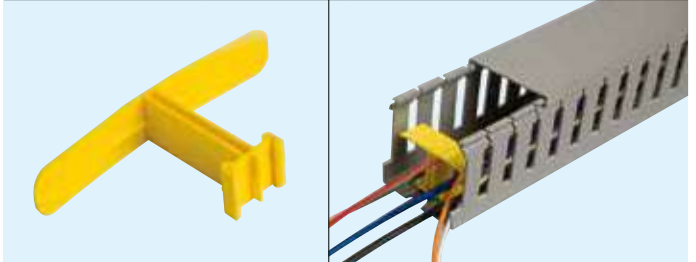
RoHS COMPLIANCE 

CODE RÉFÉRENCE	FOR TRUNKING B POUR GOULOTTE B	PACK Pcs. EMB. Pcs.
FCV12040	60/120x40	40
FCV12060	40/200x60	25

CABLE TIE HOLDER

ATTACHE DE CÂBLE PORTEUR

RoHS COMPLIANCE 

CODE RÉFÉRENCE	PACK Pcs. EMB. Pcs.
DMF	100 (2x50)

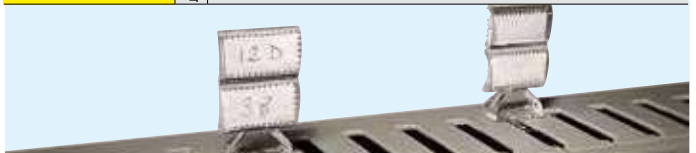
LABEL HOLDER FOR WIRE DUCTS
PORTE-ÉTIQUETTERoHS COMPLIANCE 

CODE RÉFÉRENCE	PACK Pcs. EMB. Pcs.
PTE	100 (2x50)

INDUSTRIAL WIRE DUCTS/CÂBLAGE INDUSTRIEL

ACCESSORIES/OUTILS

UNIVERSAL CABLE-HOLDER
SERRE-CÂBLE UNIVERSELRoHS COMPLIANCE 

CODE RÉFÉRENCE	FOR TRUNKING H POUR GOULOTTE H	PACK Pcs. EMB. Pcs.
FMC	60/80	40 (4x10)

WIRE DUCTS IDENTIFICATION KIT
KIT POUR L'IDENTIFICATION DU CONTENU DES GOULOTTES

RoHS COMPLIANCE

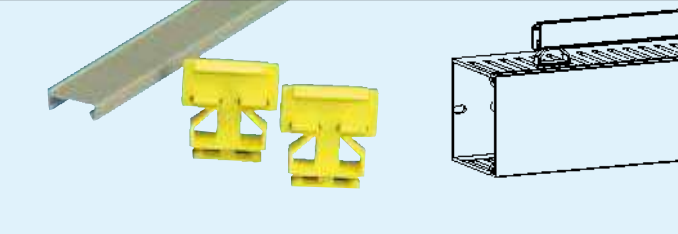

CODE RÉFÉRENCE	DESCRIPTION DESCRIPTION	PACK KIT EMB. KIT
MARK15KIT	- n. 10 label-holder cover. Bar length 0,5 m. - n. 20 cover-holders - N. 10 couvre le porte-étiquette; longueur 0,5 m. - N. 20 pour la couverture.	20

LABEL-HOLDER COVER 15mm
PORTE-ÉTIQUETTES 15 mm

RoHS COMPLIANCE



CODE RÉFÉRENCE	DESCRIPTION DESCRIPTION	PACK m EMB. m
PTECO15	Bar length 1 m. Use with PTECO/Longueur 1 m. utiliser avec PTECO	150

COVER HOLDER FOR PTECO15
PORTE-COUVERCLE POUR PTECO15

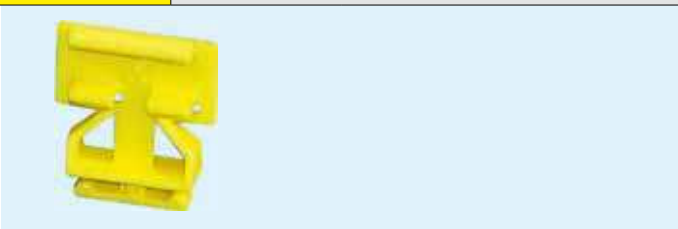

RoHS COMPLIANCE



CODE RÉFÉRENCE	PACK Pcs. EMB. Pcs.
PTECO	150



RIVETS

RoHS COMPLIANCE 

CODE RÉFÉRENCE	Ø mm	DIMENSIONS				COLOUR COULEUR	PACK Pcs. EMB. Pcs.
		A	B	C	D		
RIV1	6,5	11	6	2	14		100
RIV2	4,5	9	4,5	1,8	12		50

To fix the ducts to panels. Material: Nylon
Pour la fixation des goulottes sur les panneaux. Avec goupille attachée. Matière: Nylon

RIVETING TOOLS
PRESSE-RIVETS

CODE RÉFÉRENCE	Ø mm	DESCRIPTION DESCRIPTION	COLOUR COULEUR	PACK Pcs. EMB. Pcs.
PRRIV	6,5	For the fast installation of the RIV1 Outil pour l'application rapide des rivets RIV1		4 (4x1)
PRRIV2	4,5	For the fast installation of the RIV2 Outil pour l'application rapide des rivets RIV2		4 (4x1)

CUTTER FOR TRUNKINGS MAX 120x120 mm
COUPOIR POUR GOULOTTES MAX 120x120 mm

CODE RÉFÉRENCE	DESCRIPTION DESCRIPTION	PACK Pcs. EMB. Pcs.
ETC120	Cutter for trunkings/Cutter pour Goulottes	1
ETC120L	Spare blade/Lame de recharge	1

This bench-mounted cutter will allow you to cut precise lengths of ducts, thank to the attached ruler stuck on the side panel. The well-sharpened blade will give you burr-free results as well.
Ce banc de coupe manuel permettra une coupe précise des goulottes grâce à la barre de mesure avec plaque en laiton sur le côté de la fraise.

INDUSTRIAL WIRE DUCTS/CÂBLAGE INDUSTRIEL

ACCESSORIES/OUTILS

TOOL FOR HOLE PUNCHING WIRING DUCTS SIDES

OUTIL POUR PERÇER LA PAROI DES GOULOTTES



CODE RÉFÉRENCE	DESCRIPTION DESCRIPTION	PACK Pcs. EMB. Pcs.
ECUF	<p>Tool for punch-cutting sides of wiring ducts up to bore 4mm Repeat the action for bigger bores and for more wire ties. <i>One Piece - n'a pas les lames de rechange.</i> Permet le passage de la pince (jusqu'à 4 mm de largeur) pour la fixation des câbles, 2 ou plus par latérales d'inkings latérales permettre le passage des pinces sur 4mm.</p>	1

TOOL FOR CUTTING WIRING DUCTS SIDES

OUTIL POUR COUPER LA PAROI DES GOULOTTES



CODE RÉFÉRENCE	DESCRIPTION DESCRIPTION	P CK Pcs. EMB. Pcs.
ECUT	<p>Tool for punch-cutting sides of wiring ducts Whitout blade as spare parts. Repeat the action for bigger bores and for bunch wire <i>One Piece - n'a pas les lames de rechange.</i></p>	1

DIN RAILS/RAILS DIN MÉTALLIQUE

DIN RAIL TO SNAP-ON ELECTRICAL EQUIPMENT

RAIL DIN EN ACIER POUR ACCROCHAGE DE MATÉRIEL ÉLECTRIQUE

RoHS COMPLIANCE	DIN CEI EN 60715			
CODE RÉFÉRENCE	COLOUR COULEUR	THICKNESS mm ÉPAISSEUR mm	LENGTH m LONGUEUR m	PACK m EMB. m
PD35CZ	Senzimir	1,5	2	20

PERFORATED DIN RAIL

RAIL DIN EN ACIER PERFORÉ POUR ACCROCHAGE DE MATÉRIEL ÉLECTRIQUE

RoHS COMPLIANCE	DIN CEI EN 60715			
CODE RÉFÉRENCE	COLOUR COULEUR	THICKNESS mm ÉPAISSEUR mm	LENGTH m LONGUEUR m	PACK m EMB. m
PD35CZF6	Senzimir	1,5	2	20

DIN RAIL TO SNAP-ON ELECTRICAL EQUIPMENT

RAIL DIN EN ACIER POUR ACCROCHAGE DE MATÉRIEL ÉLECTRIQUE

RoHS COMPLIANCE	DIN CEI EN 60715			
CODE RÉFÉRENCE	COLOUR COULEUR	THICKNESS mm ÉPAISSEUR mm	LENGTH m LONGUEUR m	PACK m EMB. m
PD35Z	Senzimir	1	2	40

PERFORATED DIN RAIL

RAIL DIN EN ACIER PERFORÉ POUR ACCROCHAGE DE MATÉRIEL ÉLECTRIQUE

RoHS COMPLIANCE	DIN CEI EN 60715			
CODE RÉFÉRENCE	COLOUR COULEUR	THICKNESS mm ÉPAISSEUR mm	LENGTH m LONGUEUR m	PACK m EMB. m
PD35ZF6	Senzimir	1	2	20

INDUSTRIAL WIRE DUCTS/CÂBLAGE INDUSTRIEL

DIN RAILS/RAILS DIN MÉTALLIQUE

DIN RAILTO SNAP-ON ELECTRICAL EQUIPMENT
RAIL DIN EN ACIER
POUR ACCROCHAGE DE MATÉRIEL ÉLECTRIQUENEW
NOUVELLES

RoHS COMPLIANCE

DIN CEI EN 60715

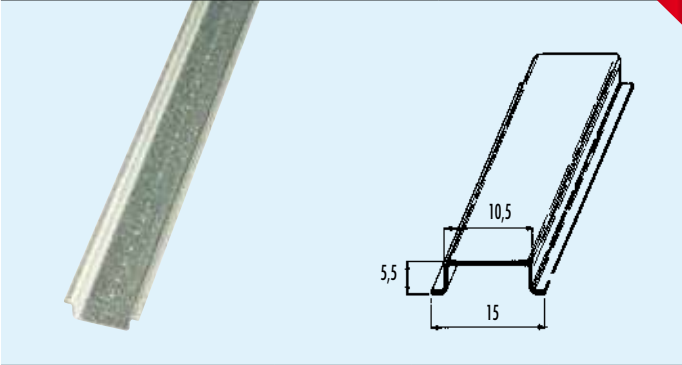

CODE RÉFÉRENCE	COLOUR COULEUR	THICKNESS mm ÉPAISSEUR mm	LENGTH m LONGUEUR m	PACK m EMB. m
PD15Z	Sendzimir	1	2	100

PERFORATED DIN RAILTO SNAP-ON ELECTRICAL EQUIPMENT
RAIL DIN EN ACIER PERFORÉ
POUR ACCROCHAGE DE MATÉRIEL ÉLECTRIQUENEW
NOUVELLES

RoHS COMPLIANCE

DIN CEI EN 60715

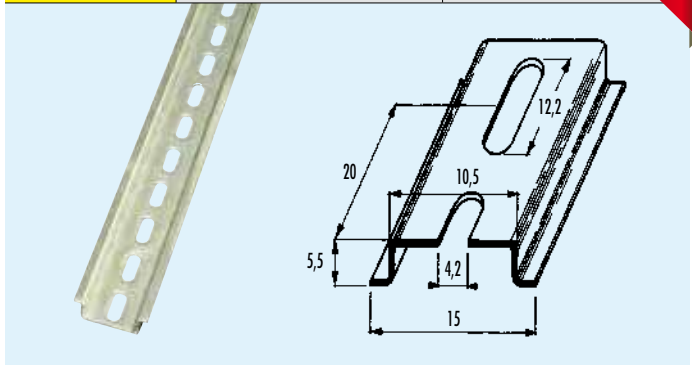

CODE RÉFÉRENCE	COLOUR COULEUR	THICKNESS mm ÉPAISSEUR mm	LENGTH m LONGUEUR m	PACK m EMB. m
PD15ZF4	Sendzimir	1	2	100

DIN RAIL TO SNAP-ON CLAMPS FOR ASSEMBLING EQUIPMENT AND
FRAMES USING THE SPECIAL COUPLING PDC 46
RAIL DIN EN ACIER POUR ACCROCHAGE DE MATÉRIEL ÉLECTRIQUE

RoHS COMPLIANCE

DIN CEI EN 60715

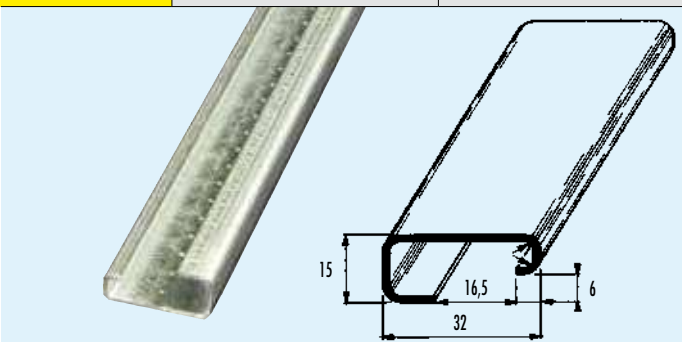

CODE RÉFÉRENCE	COLOUR COULEUR	THICKNESS mm ÉPAISSEUR mm	LENGTH m LONGUEUR m	PACK m EMB. m
PD32Z	Sendzimir	1,5	2	20

PERFORATED DIN RAIL

RAIL DIN EN ACIER PERFORÉ POUR ACCROCHAGE DE MATÉRIEL ÉLECTRIQUE

RoHS COMPLIANCE

DIN CEI EN 60715

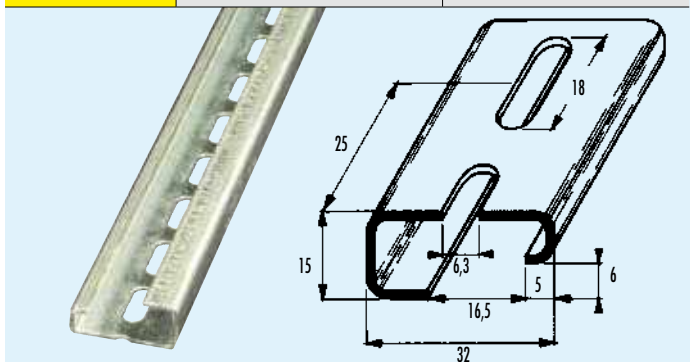

CODE RÉFÉRENCE	COLOUR COULEUR	THICKNESS mm ÉPAISSEUR mm	LENGTH m LONGUEUR m	PACK m EMB. m
PD32ZF6	Sendzimir	1,5	2	20

SUPPORT BRACKET IN GALVANISED STEEL WITH M6 THREADED HOLE
SUPPORT EN ACIER GALVANISÉ AVEC TROU TARAUDÉ M6

RoHS COMPLIANCE

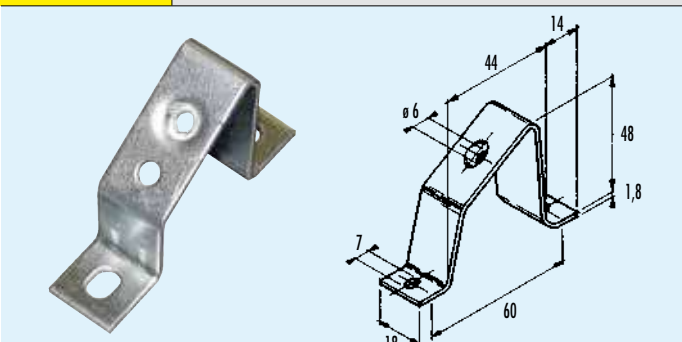

CODE RÉFÉRENCE	COLOUR COULEUR	PACK Pcs. EMB. Pcs.
PDSZM6	Sendzimir	10

MANUAL PROFILE CUTTING TOOL, 2 MOLDS
OUTIL MANUEL DE DECOUPE PERFILS A 2 MOULES

RoHS COMPLIANCE



CODE RÉFÉRENCE	PACK Pcs. EMB. Pcs.
PDTR2M	1

INDUSTRIAL WIRE DUCTS/CÂBLAGE INDUSTRIEL

DIN RAILS - ACCESSORIES/RAILS DIN MÉTALLIQUE - OUTILS

**MANUAL PROFILE CUTTING TOOL
4 MOLDS + BORES**OUTIL MANUEL DE DECOUPE PERFILS
A 4 MOULES + ENNUYERS

RoHS COMPLIANCE

NEW
NOUVELLESCODE
RÉFÉRENCEPACK Pcs.
EMB. Pcs.

PDTR4MF

1

**PNEUMATIC PROFILE CUTTING TOOL
4 MOLDS + SLOTS**OUTIL PNEUMATIQUE DE DECOUPE PERFILS
A 4 MOULES + FENTES

RoHS COMPLIANCE

NEW
NOUVELLESCODE
RÉFÉRENCEPACK Pcs.
EMB. Pcs.

PDTR4PN*

1

* Item available upon request/Article disponible sur demande

**MANUAL PROFILE CUTTING TOOL
4 MOLDS + SLOTS**OUTIL MANUEL DE DECOUPE PERFILS A
4 MOULES + FENTES

RoHS COMPLIANCE

NEW
NOUVELLESCODE
RÉFÉRENCEPACK Pcs.
EMB. Pcs.

PDTR4MFA*

1

* Item available upon request/Article disponible sur demande



INSTALLATION TRUNKINGS

- ▶ MINITRUNKINGS AND ACCESSORIES
- ▶ TRUNKING SYSTEMS AND ACCESSORIES
- ▶ "SYS45" QUICK INSTALLATION TRUNKINGS
- ▶ DISTRIBUTION BOARD TRUNKINGS
- ▶ CAVITY FLOOR SOCKET BOXES
- ▶ FLOOR SOCKET-POINT TURRETS

GOULOTTES D'INSTALLATION

- ▶ MOULURES ET ACCESSOIRES
- ▶ GOULOTTES ET ACCESSOIRES
- ▶ GOULOTTES PORTE-PRISES RAPIDE "SYS45"
- ▶ GAINES TECHNIQUE DE LOGEMENT (GTI)
- ▶ BOÎTIES DE SOL
- ▶ COLONNES DE BUREAU



INSTALLATION TRUNKINGS/GOULOTTES D'INSTALLATION

MINITRUNKINGS AND ACCESSORIES/MOULURES ET ACCESSOIRES

MINITRUNKINGS WITH HINGED COVER AND ADHESIVE BASE
WHITE COLOUR - LENGTH 2 m

MOULURES AVEC FOND AUTO-ADHÉSIF COULEUR BLANC

LONGUEUR 2 m

 SELF-EXTINGUISHING RIGID PVC CLASS 1, UL94-V0

CODE RÉFÉRENCE	DIMENSIONS (b x h) DIMENSIONS (b x h)	PACK m EMB. m
MA117	12,5x7,5	240
MA211	10x10	240
MA215	15x10	96
MA221	20x10	120
MA312	12,5x12,5	160

MINITRUNKING WITH SNAP-ON COVER
WHITE COLOUR - LENGTH 2 m

MOULURES AVEC COUVERCLE À ENCLIPSAGE

COULEUR BLANC - LONGUEUR 2 m

 SELF-EXTINGUISHING RIGID PVC CLASS 1, UL94-V0

CODE RÉFÉRENCE	DIMENSIONS (b x h) DIMENSIONS (b x h)	PACK m EMB. m
G21BEU	10x10	240
G41BEU	20x10	120
G20BEU	15x18	120
G44BEU	25x20	60
G45BEU	40x20x2sc	42
G46BEU	60x20x3sc	28

MINITRUNKINGS WITH WRAPPING COVER WHITE COLOUR
LENGTH 2 m

MOULURES AVEC COUVERCLE RECOUVRANT COULEUR BLANC

LONGUEUR 2 m

 SELF-EXTINGUISHING RIGID PVC CLASS 1, UL94-V0

CODE RÉFÉRENCE	DIMENSIONS (b x h) DIMENSIONS (b x h)	PACK m EMB. m
MS201BEU	20x10	120
MS301BEU	30x10	90
MS4010BEU	40x10x2sc	68
BS11BEU	16x16	96
BS21BEU	25x16	72
BS31BEU	40x16x2sc	54
BS61BEU	60x16x3sc	36

OUTER BEND
ANGLE EXTERIEUR

CODE RÉFÉRENCE	FOR TRUNKING POUR GOULOTTE	PACK Pcs. EMB. Pcs.
MINI41EBEU	20x10	40
MINI30EBEU	30x10	40
MINI40EBEU	40x10	40
MINI11EBEU	16x16	40
MINI21EBEU	25x16	40
MINI31EBEU	40x16	40
MINI61EBEU	60x16	40
MINI44EBEU	25x20	20
GT248EBEU	40x20/40	10
GT244EBEU	60x20/40	10

INNER BEND
ANGLE INTERIEUR

CODE RÉFÉRENCE	FOR TRUNKING POUR GOULOTTE	PACK Pcs. EMB. Pcs.
MINI41IBEU	20x10	40
MINI30IBEU	30x10	40
MINI40IBEU	40x10	40
MINI11IBEU	16x16	40
MINI21IBEU	25x16	40
MINI31IBEU	40x16	40
MINI61IBEU	60x16	40
MINI44IBEU	25x20	20
GT248IBEU	40x20/40	10
GT244IBEU	60x20/40	10

COVER JOINT
JOINT DE JONCTION

CODE RÉFÉRENCE	FOR TRUNKING POUR GOULOTTE	PACK Pcs. EMB. Pcs.
MINI41GBEU	20x10	40
MINI30GBEU	30x10	40
MINI40GBEU	40x10	40
MINI11GBEU	16x16	40
MINI21GBEU	25x16	40
MINI31GBEU	40x16	40
MINI61GBEU	60x16	40
MINI44GBEU	25x20	20
GT248GBEU	40x20/40	20
GT244GBEU	60x20/40	20

INSTALLATION TRUNKINGS/GOULOTTES D'INSTALLATION

MINITRUNKINGS AND ACCESSORIES/MOULURES ET ACCESSOIRES

L-JOINT FOR FLAT BEND
ANGLE PLAT 90°

CODE RÉFÉRENCE	FOR TRUNKING POUR GOULOTTE	PACK Pcs. EMB. Pcs.
MINI41LBEU	20x10	40
MINI30LBEU	30x10	40
MINI40LBEU	40x10	40
MINI11LBEU	16x16	40
MINI21LBEU	25x16	40
MINI31LBEU	40x16	40
MINI61LBEU	60x16	40
MINI44LBEU	25x20	20
GT248LBEU	40x20/40	10
GT244LBEU	60x20/40	10

T-JOINT FOR WALL DEVIATIONS
DÉRIVATION EN T

CODE RÉFÉRENCE	FOR TRUNKING POUR GOULOTTE	PACK Pcs. EMB. Pcs.
MINI41TBEU	20x10	40
MINI30TBEU	30x10	40
MINI40TBEU	40x10	40
MINI11TBEU	16x16	40
MINI21TBEU	25x16	40
MINI31TBEU	40x16	40
MINI61TBEU	60x16	20
MINI44TBEU	25x20	20
GT248TBEU	40x20/40	10
GT244TBEU	60x20/40	10

END CAP
EMBOUT DE FERMETURE

CODE RÉFÉRENCE	FOR TRUNKING POUR GOULOTTE	PACK Pcs. EMB. Pcs.
MINI41SBEU	20x10	40
MINI30SBEU	30x10	40
MINI40SBEU	40x10	40
MINI11SBEU	16x16	40
MINI21SBEU	25x16	40
MINI31SBEU	40x16	40
MINI61SBEU	60x16	40
GT16ABEU	25x20	20
GT248ABEU	40x20/40	10
GT244ABEU	60x20/40	10

JUNCTION BOX
BOÎTE DE DÉRIVATION

CODE RÉFÉRENCE	DIMENSIONS (b x h) DIMENSIONS (B X H)	PACK Pcs. EMB. Pcs.
SCM090	90x90x36	10

SOCKET BOX FOR SWITCHES - ABS GWT 850°C (UL94-V0)
SELF-EXTINGUISHING
BOÎTIER DE PRISE - ABS GWT 850°C (UL94-V0) AUTO-EXTINGUIBLE

CODE	DIMENSIONS	MODULES	DISTANCE	PACK Pcs.
SCSBEU*	100x90x50	2	60/55	9
VPG18SBEU	130x90x50	3	83,5	9

*only for minitrunking h. 10-16/seulement pour les moulures h. 10 - 16

MINITRUNKINGS CUTTINGS TOOL
PINCE COUPANTE POUR GOULOTTES

CODE	DESCRIPTION	PACK Pcs.
MCE15	Cutting tool/ Secateur	1
MLA15	Spare blade/ Lame de rechange	1

CABLE-RETAINING CROSS-ARMS

TRAVERSES POUR CONTENIR LES FILS ÉLECTRIQUES DANS LES GOULOTTES

RoHS COMPLIANCE



CODE RÉFÉRENCE	FOR TRUNKING B POUR GOULOTTE B	PACK Pcs. EMB. Pcs.
FCV12040	60/120x40	40
FCV12060	40/200x60	25

INSTALLATION TRUNKINGS/GOULOTTES D'INSTALLATION

TRUNKING SYSTEMS AND ACCESSORIES/GOULOTTES ET ACCESSOIRES

CABLE TRUNKING SYSTEMS "TIPO G" LENGTH 2 m
GOULOTTES DE DISTRIBUTION STANDARD "TIPO G" LONG. 2 m

SELF-EXTINGUISHING RIGID PVC CLASS 1, UL94-V0

NEW
NOUVELLES

CODE RÉFÉRENCE	DIMENSIONS (b x h) DIMENSIONS (b x h)	COLOUR COULEUR	PACK m EMB m
G16	25x30		80
G13	25x40		60
G23	40x30		48
G8	40x40		40
G5	• 40x60		36
G24	60x30		32
G4	• 60x40		24
G9	• 60x60		24
G11	• 60x80		24
G26	• 80x40		24
G6	• 80x60		24
G12	• 80x80		24
G27	• 100x40		16
G17	• 100x60		20
G19	• 100x80		16
G37	• 100x100		16
G43	100x150		8
G28	• 120x40		20
G10	• 120x60		16
G32	• 120x80		16
G38	• 120x100		8
G47	120x120		8
G30	• 150x60		12
G33	• 150x80		12
G39	• 150x100		8
G31	• 200x60		8
G48	• 200x80		8
G40	• 200x100		8
G50 (NEW)	• 250x70		8
G16BEU	25x30		80
G23BEU	40x30		48
G8BEU	40x40		40
G24BEU	60x30		32
G4BEU	• 60x40		24
G9BEU	• 60x60		24
G26BEU	• 80x40		24
G6BEU	• 80x60		24
G27BEU	• 100x40		16
G17BEU	• 100x60		20
G19BEU	• 100x80		16
G28BEU	• 120x40		20
G10BEU	• 120x60		16
G32BEU	• 120x80		16
G30BEU	• 150x60		12
G33BEU	• 150x80		12
G31BEU	• 200x60		8
G48BEU	• 200x80		8
G40BEU	• 200x100		8
G50BEU (NEW)	• 250x70		8

• Wire ducts with built-in bottom rails/ Goulottes avec guide intégrée au fond

All trunkings are supplied complete with covers/ Toutes les goulottes sont fournies avec couvercles.

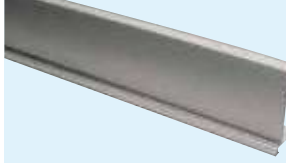
CABLE SEPARATOR - GREY COLOUR
CLOISON DE SEPARATION - COULEUR GRIS

CODE RÉFÉRENCE	DIMENSIONS (h) DIMENSIONS (h)	PACK m EMB m
S1	40 (2 separators)	30
S2	60	50
S3	40	60
S4	80	32
S5	100	32

END CAP
EMBOUIT DE FERMETURE

CODE RÉFÉRENCE	FOR TRUNKING POUR GOULOTTE	COLOUR COULEUR	PACK Pcs. EMB. Pcs.
GT16AG	25x20/30		20
GT248AG	40x20/30/40		20
GT244AG	60x20/30/40		10
GT9AG	60x60		10
GT26AG	80x40		10
GT6AG	80x60		10
GT100AG	100x40/50/60/75/80/100		10
GT133AG	120x40/60/80/100		10
GT333AG	150x60/80/100		10
GT344AG	200x60/80/100		10
GT13AG*	25x40		10
GT5AG*	40x60		10
GT11AG*	60x80		10
GT12AG*	80x80		10
GT16ABEU	25x20/30		20
GT248ABEU	40x20/30/40		20
GT244ABEU	60x20/30/40		10
GT9ABEU	60x60		10
GT26ABEU	80x40		10
GT6ABEU	80x60		10
GT100ABEU	100x40/50/60/75/80/100		10
GT133ABEU	120x40/60/80/100		10
GT333ABEU	150x60/80/100		10
GT344ABEU	200x60/80/100		10
GT133ABEU	120x40/60/80/100		10
GT333ABEU	150x60/80/100		10
GT344ABEU	200x60/80/100		10

* Upon request and for quantities to be agreed/ Sur demande et pour des quantités à convenir.

INSTALLATION TRUNKINGS/GOULOTTES D'INSTALLATION

TRUNKING SYSTEMS AND ACCESSORIES/GOULOTTES ET ACCESSOIRES

COVER JOINT

JOINT DE JONCTION



CODE RÉFÉRENCE	FOR TRUNKING POUR GOULOTTE	COLOUR COULEUR	PACK Pcs. EMB. Pcs.
GT16GG	25x30		20
GT248GG	40x20/30/40		20
GT244GG	60x20/30/40		20
GT60GG	60x60/80/100		30
GT80GG	80x40/60/80/100		30
GT100GG	100x40/60/80/100		30
GT120GG	120x40/60/80/100		30
GT150GG	150x60/80/100		30
GT200GG	200x60/80/100		30
GT13GG*	25x40		10
GT5GG*	40x60		10
GT16GBEU	25x30		20
GT248GBEU	40x20/30/40		20
GT244GBEU	60x20/30/40		20
GT60GBEU	60x60/80/100		30
GT80GBEU	80x40/60/80/100		30
GT100GBEU	100x40/60/80/100		30
GT120GBEU	120x40/60/80/100		30
GT150GBEU	150x60/80/100		30
GT200GBEU	200x60/80/100		30

* Upon request and for quantities to be agreed/Sur demande et pour des quantités à convenir

GHF-P SERIES " HALOGEN FREE CABLE TRUNKING

GOULOTTES DE DISTRIBUTION SANS HALOGEN GHF-P

Items supplied upon request and for quantities be agreed
Articles fournis sur demande et pour des quantités convenues.

OUTER BEND

ANGLE EXTERIEUR



CODE RÉFÉRENCE	FOR TRUNKING POUR GOULOTTE	COLOUR COULEUR	PACK Pcs. EMB. Pcs.
GT16EG	25x30		20
GT248EG	40x20/30/40		10
GT244EG	60x20/30/40		10
GT9EG	60x60		10
GT26EG	80x40		10
GT6EG	80x60		10
GT12EG	80x80		10
GT27EG	100x40		10
GT17EG	100x60		10
GT19EG	100x80		4
GT37EG	100x100		4
GT28EG	120x40		4
GT10EG	120x60		4
GT32EG	120x80		4
GT38EG	120x100		4
GT30EG	150x60		4
GT33EG	150x80		4
GT39EG	150x100		4
GT31EG	200x60		4
GT48EG	200x80		4
GT40EG	200x100		4
GT13EG*	25x40		10
GT5EG*	40x60		10
GT11EG*	60x80		10
GT16EBEU	25x30		20
GT248EBEU	40x20/30/40		10
GT244EBEU	60x20/30/40		10
GT9EBEU	60x60		10
GT26EBEU	80x40		10
GT6EBEU	80x60		10
GT27EBEU	100x40		10
GT17EBEU	100x60		10
GT19EBEU	100x80		4
GT28EBEU	120x40		4
GT10EBEU	120x60		4
GT32EBEU	120x80		4
GT30EBEU	150x60		4
GT33EBEU	150x80		4
GT31EBEU	200x60		4
GT48EBEU	200x80		4
GT40EBEU	200x100		4

* Upon request and for quantities to be agreed/Sur demande et pour des quantités à convenir

INSTALLATION TRUNKINGS/GOULOTTES D'INSTALLATION

TRUNKING SYSTEMS AND ACCESSORIES/GOULOTTES ET ACCESSOIRES

INNER BEND
ANGLE INTERIEUR

CODE RÉFÉRENCE	FOR TRUNKING POUR GOULOTTE	COLOUR COULEUR	PACK Pcs. EMB. Pcs.
GT16IG	25x30		20
GT248IG	40x20/30/40		10
GT244IG	60x20/30/40		10
GT9IG	60x60		10
GT26IG	80x40		10
GT6IG	80x60		10
GT12IG	80x80		10
GT27IG	100x40		10
GT17IG	100x60		10
GT19IG	100x80		4
GT37IG	100x100		4
GT28IG	120x40		4
GT10IG	120x60		4
GT32IG	120x80		4
GT38IG	120x100		4
GT30IG	150x60		4
GT33IG	150x80		4
GT39IG	150x100		4
GT31IG	200x60		4
GT48IG	200x80		4
GT40IG	200x100		4
GT13IG*	25x40		10
GT5IG*	40x60		10
GT11IG*	60x80		10
GT16IBEU	25x30		20
GT248IBEU	40x20/30/40		10
GT244IBEU	60x20/30/40		10
GT9IBEU	60x60		10
GT26IBEU	80x40		10
GT6IBEU	80x60		10
GT27IBEU	100x40		10
GT17IBEU	100x60		10
GT19IBEU	100x80		4
GT28IBEU	120x40		4
GT10IBEU	120x60		4
GT32IBEU	120x80		4
GT30IBEU	150x60		4
GT33IBEU	150x80		4
GT31IBEU	200x60		4
GT48IBEU	200x80		4
GT40IBEU	200x100		4

* Upon request and for quantities to be agreed/Sur demande et pour des quantités à convenir

L-JOINT FOR FLAT BEND
ANGLE PLAT 90°

CODE RÉFÉRENCE	FOR TRUNKING POUR GOULOTTE	COLOUR COULEUR	PACK Pcs. EMB. Pcs.
GT16LG	25x30		20
GT248LG	40x20/30/40		10
GT244LG	60x20/30/40		10
GT9LG	60x60		10
GT26LG	80x40		10
GT6LG	80x60		10
GT12LG	80x80		10
GT27LG	100x40		10
GT17LG	100x60		10
GT19LG	100x80		8
GT37LG	100x100		8
GT28LG	120x40		8
GT10LG	120x60		8
GT32LG	120x80		4
GT38LG	120x100		4
GT30LG	150x60		4
GT33LG	150x80		4
GT39LG	150x100		4
GT31LG	200x60		4
GT48LG	200x80		4
GT40LG	200x100		4
GT13LG*	25x40		10
GT5LG*	40x60		10
GT11LG*	60x80		10
GT16LBEU	25x30		20
GT248LBEU	40x20/30/40		10
GT244LBEU	60x20/30/40		10
GT9LBEU	60x60		10
GT26LBEU	80x40		10
GT6LBEU	80x60		10
GT27LBEU	100x40		10
GT17LBEU	100x60		10
GT19LBEU	100x80		8
GT28LBEU	120x40		8
GT10LBEU	120x60		4
GT32LBEU	120x80		4
GT30LBEU	150x60		4
GT33LBEU	150x80		4
GT31LBEU	200x60		4
GT48LBEU	200x80		4
GT40LBEU	200x100		4

* Upon request and for quantities to be agreed/Sur demande et pour des quantités à convenir

INSTALLATION TRUNKINGS/GOULOTTES D'INSTALLATION

TRUNKING SYSTEMS AND ACCESSORIES/GOULOTTES ET ACCESSOIRES

T-JOINT FOR WALL DEVIATIONS

DÉRIVATION EN T



CODE RÉFÉRENCE	FOR TRUNKING POUR GOULOTTE	COLOUR COULEUR	PACK Pcs. EMB. Pcs.
GT16TG	25x30		20
GT248TG	40x20/30/40		10
GT244TG	60x20/30/40		10
GT9TG	60x60		10
GT26TG	80x40		10
GT6TG	80x60		10
GT12TG	80x80		10
GT27TG	100x40		10
GT17TG	100x60		10
GT19TG	100x80		8
GT37TG	100x100		8
GT28TG	120x40		8
GT10TG	120x60		20
GT32TG	120x80		10
GT38TG	120x100		10
GT30TG	150x60		10
GT33TG	150x80		10
GT39TG	150x100		10
GT31TG	200x60		10
GT48TG	200x80		10
GT40TG	200x100		10
GT13TG*	25x40		8
GT5TG*	40x60		8
GT11TG*	60x80		8
GT16TBEU	25x30		20
GT248TBEU	40x20/30/40		10
GT244TBEU	60x20/30/40		10
GT9TBEU	60x60		10
GT26TBEU	80x40		10
GT6TBEU	80x60		10
GT27TBEU	100x40		10
GT17TBEU	100x60		10
GT19TBEU	100x80		8
GT28TBEU	120x40		8
GT10TBEU	120x60		20
GT32TBEU	120x80		10
GT30TBEU	150x60		10
GT33TBEU	150x80		10
GT31TBEU	200x60		10
GT48TBEU	200x80		10
GT40TBEU	200x100		10

* Upon request and for quantities to be agreed/Sur demande et pour des quantités à convenir

CROSS ARM FOR RETAINING CABLES AND SEPARATOR

ACCESSOIRES CROIX CÂBLE

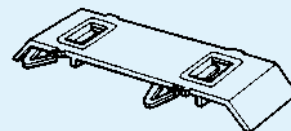

CODE RÉFÉRENCE	FOR TRUNKING (B) POUR GOULOTTE (B)	PACK Pcs. EMB. Pcs.
PCT050	60	100
PCT075	80/100	100
PCT100	120	100
PCT125	150/200	100

TRUNKING JOINT AND ARTICULATED COUPLING

JOINT ARTICULE

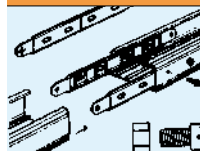

CODE RÉFÉRENCE	FOR TRUNKING (B) POUR GOULOTTE (B)	PACK Pcs. EMB. Pcs.
LDG50	40/50	20
LDG60	60	20
LDG75	80	20
LDG100	100/120	20

DUCT JOINTING PLATE

PLAT JONCTION GOULOTTES

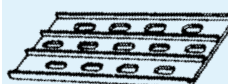

CODE RÉFÉRENCE	FOR TRUNKING (B) POUR GOULOTTE (B)	PACK Pcs. EMB. Pcs.
PG	G12-G19-G32-G33-G48-G37 G38-G39-G40-G47-G43	100

"MEZZOTONDO" FLOOR TRUNKING - LENGTH 2 m

PASSAGE DE PLANCHER "MEZZOTONDO" - LONGUEUR 2m



CODE RÉFÉRENCE	DIMENSIONS DIMENSIONS	COLOUR COULEUR	PACK m EMB. m
ZBF	75x18x4 compartiments		40
ZBFBE*	75x18x4 compartiments		40

* Upon request and for quantities to be agreed/Sur demande et pour des quantités à convenir

INSTALLATION TRUNKINGS/GOULOTTES D'INSTALLATION

"SYS45" QUICK INSTALLATION TRUNKINGS/GOULOTTES PORTE-PRISES RAPIDE "SYS45"

"SYS45" QUICK INSTALLATION TRUNKINGS**COLOUR WHITE RAL 9010 - LENGTH 2 m**

GOULOTTES TERTIAIRE "SYS45 RAPID" COULEUR BLANC RAL 9010 - LONGUEUR 2 m

		GMT 850°	CONFORMING TO: LVD 2006/95/CE, EN 50085-2-1	UL94-V0 GRADE PVC IP40
--	---	-----------------	--	------------------------



CODE RÉFÉRENCE	DIMENSIONS DIMENSIONS	PACK m EMB. m
SYS751	75x50x1	24
SYS1051	100x50x1	16
SYS1252	125x50x2	16
SYS1603	160x50x3	12

All trunkings are supplied complete with covers/ Toutes les goulottes sont fournies avec couvercles

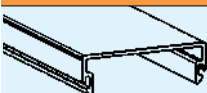
COVER/COUVERCLE POUR GOULOTTE SYS45 RAPID

CODE RÉFÉRENCE	B	PACK m EMB. m
SCO45	45	64

OUTER BEND/ANGLE EXTERIEUR

CODE RÉFÉRENCE	FOR TRUNKING POUR GOULOTTE	PACK Pcs. EMB. Pcs.
LD075EBEU	75x50x1	16
LD105EBEU	100x50x1	15
LD125EBEU	125x50x2	10
SAE160BEU	160x50x3	4

INNER BEND/ANGLE INTERIEUR

CODE RÉFÉRENCE	FOR TRUNKING POUR GOULOTTE	PACK Pcs. EMB. Pcs.
LD075IBEU	75x50x1	16
LD105IBEU	100x50x1	15
LD125IBEU	125x50x2	10
SAI160BEU	160x50x3	10

STAINLESS TONGS FOR A BETER GRIP ON SOCKETS

PINCE INOX POUR UNE MEILLEURE TENUE DES PRISES



CODE RÉFÉRENCE	PACK Pcs. EMB. Pcs.
SYML	100

L-JOINT FOR FLAT BEND/ ANGLE PLAT 90°

CODE RÉFÉRENCE	FOR TRUNKING POUR GOULOTTE	PACK Pcs. EMB. Pcs.
LD075LBEU	75x50x1	20
LD105LBEU	100x50x1	10
LD125LBEU	125x50x2	8
SAP160BEU	160x50x3	8

T-JOINT FOR WALL DEVIATION/DÉRIVATION EN T

CODE RÉFÉRENCE	FOR TRUNKING POUR GOULOTTE	PACK Pcs. EMB. Pcs.
LD075TBEU	75x50x1	12
LD105TBEU	100x50x1	15
LD125TBEU	125x50x2	10
SGT160BEU	160x50x3	12

COVER JOINT/JOINT DE JONCTION

CODE RÉFÉRENCE	FOR TRUNKING POUR GOULOTTE	PACK Pcs. EMB. Pcs.
SGCOBEU		20

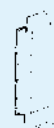
ADAPTOR FOR SYS1603/RÉDUCTEUR SYS 1603

CODE RÉFÉRENCE	FOR TRUNKING POUR GOULOTTE	PACK Pcs. EMB. Pcs.
SADCBEU	160x50x3	16

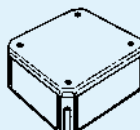
JUNCTION BOX FOR TRUNKINGS/BOÎTIER DE DÉRIVATION

CODE RÉFÉRENCE	PACK Pcs. EMB. Pcs.
LDSDBEU	4

INSTALLATION TRUNKINGS/GOULOTTES D'INSTALLATION

"SYS45" QUICK INSTALLATION TRUNKINGS - TECHNICAL DATA/GOULOTTES PORTE-PRISES RAPIDE "SYS45" - C. TECHNIQUES

TRUNKING JOINT/JOINT DE FOND

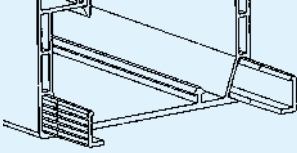









CODE RÉFÉRENCE	PACK Pcs. EMB. Pcs.
SGACBEU	50 (5x10)









END CAP/EMBOU DE FERMETURE



CODE RÉFÉRENCE	FOR TRUNKING POUR GOULOTTE	PACK Pcs. EMB. Pcs.
LD075ABEU	75x50x1	20
GT100ABEU	100x50x1	10
STT125BEU	125x50x2	10
STT160BEU	160x50x3	10

SWITCHES - SOCKETS/ INTERRUPTEUR - PRISE

	CODE RÉFÉRENCE	DESCRIPTION DESCRIPTION	COLOUR COULEUR	PACK Pcs. EMB. Pcs.
	CP2710	Switch 10 A, 250V Interrupteur 10 A, 250V		30
	CP2800	Schuko +T, 10 A, 250V Prise schuko +T, 10 A, 250V		30
	CP2810	Schuko +T, 10 A, 250V Prise schuko +T, 10 A, 250V		30
	CP2811	French socket +T, 10 A, 250V Prise française+T, 10 A, 250V		30

	CODE RÉFÉRENCE	DESCRIPTION DESCRIPTION	COLOUR COULEUR	PACK Pcs. EMB. Pcs.
	CP2812	UK socket +T, 10 A, 250V Prise anglaise+T, 10 A, 250V		30
	CP2813	French socket +T, 10 A, 250V Prise Française +T, 10 A, 250V		30
	CP2814	Data socket RJ45 Prise données RJ45		30
	CP2815	Data socket RJ45 double Prise données RJ45 double		30

SYS 751

Sys 751 socket-point raceway 1 compartment mm 75x50x1. Usable section 2255 mm². Compatible with junction Box mm 165x165./Sys 751 goulotte appareillable à 1 compartiment mm 75x50x1. Section utile 2255 mm². Boîte de dérivation mm 165x165.



SYS 1051

Sys 1051 socket-point raceway 1 compartment mm 100x50x1. Usable section 3150 mm². Compatible with junction Box mm 165x165./Sys 1051 goulotte appareillable à 1 compartiment mm 100x50x1. Section utile 3150 mm². Boîte de dérivation mm 165x165.



SYS 1252

Sys 1252 Socket-point raceway 2 compartments mm 125x50x2 usable section 2310mm². Compatible with junction Box mm 165x165./Sys 1252 goulotte appareillable à 2 compartiments mm 125x50x2. Section utile 2310 mm². Boîte de dérivation mm 165x165.



SYS 1603

Sys 1603 socket-point raceway 3 compartments mm 160x50x3 usable section 2050 mm² (1-3) - 2070 mm² (2). Compatible with junction Box mm 165x165. /Sys 1603 goulotte appareillable à 3 compartiments mm 160x50x3. Section utile 2050 mm² (1-3) - 2070 mm² (2). Boîte de dérivation mm 165x165.



INSTALLATION TRUNKINGS/GOULOTTES D'INSTALLATION

DISTRIBUTION BOARD TRUNKINGS/GAINES TECHNIQUE DE LOGEMENT (GTL)

INSTALLATION TRUNKINGS, INCLUDING COVER REMOVABLE BY TOOL - LENGHT 2 m

GOULOTTES D'INSTALLATION COMPLÈTE AVEC COUVERCLE

AMOVIBLE AVEC L'OUTIL - LONGUEUR 2 m

 SELF-EXTINGUISHING RIGID PVC CLASS 1, UL94-V0

CODE RÉFÉRENCE	DIMENSIONS (b x h) DIMENSIONS (b x h)	PACK m EMB m
LDC022BEU	25x25	80
LDC032BEU	37,5x25	52
LDC033BEU	37,5x37,5	36
LDC053BEU	• 50x37,5	28
LDC055BEU	• 50x50	24
LDC075BEU	• 75x50	20
LDC105BEU	• 100x50	16
LDC125BEU	• 125x50	20
LDC155BEU	• 150x50	12
LDC205BEU	• 200x50	12
LDC077BEU	• 75x75	20
LDC107BEU	• 100x75	16
LDC127BEU	• 125x75	12
LDC157BEU	• 150x75	8
LDC207BEU	• 200x75	8

• Wire ducts with built-in bottom rails/ Goulottes avec guide intégrée au fond

All trunkings are supplied complete with covers/ Toutes les goulottes sont fournies avec couvercles.

CABLE TRUNKINGS WITH RAILS ON THE BOTTOM - LENGHT 2 m

GOULOTTES AVEC GUIDE INTÉGRÉE AU FOND - LONGUEUR 2 m

 SELF-EXTINGUISHING RIGID PVC CLASS 1, UL94-V0

CODE RÉFÉRENCE	DIMENSIONS (b x h) DIMENSIONS (b x h)	PACK m EMB m
LD100CABEU	100x50	24
LD150CABEU	150x50	12
LD200CABEU	200x50	12

COVER/COUVERCLE POUR GOULOTTE



CODE RÉFÉRENCE	DIMENSIONS (b) DIMENSIONS (b)	PACK m EMB m
LD050COBEU	50	96
LD100COBEU	100	48
LD150COBEU	150	16
LD200COBEU	200	16

OUTER BEND/ANGLE EXTERIEUR



CODE RÉFÉRENCE	FOR TRUNKING POUR GOULOTTE	PACK Pcs. EMB. Pcs.
LD022EBEU	25x25	25
LD032EBEU	37,5x25	20
LD033EBEU	37,5x37,5	20
LD053EBEU	50x37,5	16
LD055EBEU	50x50	16
LD075EBEU	75x50	16
LD105EBEU	100x50	15
LD125EBEU	125x50	10
LD155EBEU	150x50	4
LD205EBEU	200x50	4
LD077EBEU	75x75	16
LD107EBEU	100x75	4
LD127EBEU	125x75	4
LD157EBEU	150x75	4
LD207EBEU	200x75	4

INNER BEND/ANGLE INTERIEUR



CODE RÉFÉRENCE	FOR TRUNKING POUR GOULOTTE	PACK Pcs. EMB. Pcs.
LD022IBEU	25x25	25
LD032IBEU	37,5x25	20
LD033IBEU	37,5x37,5	20
LD053IBEU	50x37,5	12
LD055IBEU	50x50	12
LD075IBEU	75x50	16
LD105IBEU	100x50	15
LD125IBEU	125x50	10
LD155IBEU	150x50	10
LD205IBEU	200x50	4
LD077IBEU	75x75	15
LD107IBEU	100x75	4
LD127IBEU	125x75	4
LD157IBEU	150x75	4
LD207IBEU	200x75	4

PLATE FOR MOD. 503/504 AND 506 FOR USE LINEADIN TRUNKINGS 100-150-200 H50

PLAQUE POUR MOD. 503-504 ET 506 POUR GOULOTTES LINEADIN 100-150-200 H. 50

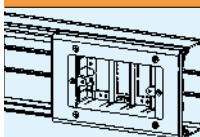

CODE RÉFÉRENCE	PACK Pcs. EMB. Pcs.
LDM504BEU	25
LDM506BEU	20

INSTALLATION TRUNKINGS/GOULOTTES D'INSTALLATION

DISTRIBUTION BOARD TRUNKINGS/GAINES TECHNIQUE DE LOGEMENT (GTL)

CENTRAL SEPARATOR - GREY COLOUR SÉPARATEUR CENTRAL - COULEUR GRIS



CODE RÉFÉRENCE	DIMENSIONS h DIMENSIONS h	PACK m EMB. m
LDSC50	50	50
LDSC75	75	25

LATERAL SEPARATOR / CLOISON DE SEPARATION



CODE RÉFÉRENCE	DIMENSIONS h DIMENSIONS h	PACK m EMB. m
LDS50	50	50
LDS75	75	50

END CAP/ EMBOUT DE FERMETURE



CODE RÉFÉRENCE	FOR TRUNKING POUR GOULOTTE	PACK Pcs. EMB. Pcs.
LD022ABEU	25x25	25
LD032ABEU	37,5x25	20
LD033ABEU	37,5x37,5	20
LD053ABEU	50x37,5	20
LD055ABEU	50x50	20
LD075ABEU	75x50	20
GT100ABEU	100x50 - 100x75	10
LD127ABEU	125x50 - 125x75	10
LD155ABEU	150x50	10
LD205ABEU	200x50	10
LD077ABEU	75x75	10
LD157ABEU	150x75	10
LD207ABEU	200x75	10

L-JOINT FOR FLAT BEND/ ANGLE PLAT 90°



CODE RÉFÉRENCE	FOR TRUNKING POUR GOULOTTE	PACK Pcs. EMB. Pcs.
LD022LBEU	25x25	25
LD032LBEU	37,5x25	20
LD033LBEU	37,5x37,5	20
LD053LBEU	50x37,5	16
LD055LBEU	50x50	16
LD075LBEU	75x50	20
LD105LBEU	100x50	10
LD125LBEU	125x50	8
LD155LBEU	150x50	10
LD205LBEU	200x50	4
LD077LBEU*	75x75	10
LD107LBEU*	100x75	4
LD127LBEU*	125x75	4
LD157LBEU	150x75	4
LD207LBEU	200x75	4

*Available on request and for quantities to be agreed/Disponible sur demande et pour des quantités à convenir

COVER JOINT/JOINT DE JONCTION



CODE RÉFÉRENCE	FOR TRUNKING POUR GOULOTTE	PACK Pcs. EMB. Pcs.
LD022GBEU	25x25	25
LD032GBEU	37,5x25	20
LD033GBEU	37,5x37,5	20
LD053TBEU	50x37,5	12
LD055TBEU	50x50	12
LD075TBEU	75x50	12
LD105GBEU	100x50	30
LD125GBEU	125x50	30
LD155GBEU	150x50	30
LD205GBEU	200x50	30
LD077GBEU*	75x75	20
LD107GBEU	100x75	30
LD127GBEU	125x75	30
LD157GBEU	150x75	30
LD207GBEU	200x75	30

*Available on request and for quantities to be agreed/Disponible sur demande et pour des quantités à convenir

T-JOINT FOR WALL DEVIATIONS / DÉRIVATION EN T



CODE RÉFÉRENCE	FOR TRUNKING POUR GOULOTTE	PACK Pcs. EMB. Pcs.
LD022TBEU	25x25	25
LD032TBEU	37,5x25	20
LD033TBEU	37,5x37,5	20
LD053TBEU	50x37,5	12
LD055TBEU	50x50	12
LD075TBEU	75x50	12
LD105TBEU	100x50	15
LD125TBEU	125x50	10
LD155TBEU	150x50	10
LD205TBEU	200x50	8
LD077TBEU	75x75	10
LD107TBEU	100x75	4
LD127TBEU	125x75	4
LD157TBEU	150x75	4
LD207TBEU	200x75	4

CROSS ARM FOR CABLES RETENTION / CLIP DE MAINTIEN



CODE RÉFÉRENCE	DIMENSIONS b DIMENSIONS b	PACK m EMB. m
LDT50	50	500 (5X100)
LDT75	75	300 (3X100)
LDT100	100	200(2X100)
LDT125	125	150 (2X75)
LDT150	150	50
LDT200	200	50

INSTALLATION TRUNKINGS/GOULOTTES D'INSTALLATION

DISTRIBUTION BOARD TRUNKINGS/GAINES TECHNIQUE DE LOGEMENT (GTL)

DISTRIBUTION BOARD TRUNKINGS KIT 250 mm KIT GAINES TECHNIQUE DE LOGEMENT (GTL) 250 mm



CODE RÉFÉRENCE	DESCRIPTION DESCRIPTION	PACK Pcs. EMB. Pcs.
KIT250	1 trunking length 1250mm L=100 mm 1 trunking length 1250mm L=150 mm 2 trunkings matching profile 1250 mm 1 goulotte long. 1250 mm L=100 mm 1 goulotte long. 1250 mm L=150 mm 2 profiles de liaison laterale 1250 mm	1

DISTRIBUTION BOARD TRUNKINGS KIT 350 mm KIT GAINES TECHNIQUE DE LOGEMENT (GTL) 350 mm



CODE RÉFÉRENCE	DESCRIPTION DESCRIPTION	PACK Pcs. EMB. Pcs.
KIT350	1 trunking length 1250mm W=200mm 1 trunking length 1250mm W=150mm 2 couplings between two trunkings. 1250mm 1 goulotte long. 1250 mm L=200 mm 1 goulotte long. 1250 mm L=150 mm 2 profiles de liaison laterale 1250 mm	1

TRUNKING MATCHING PROFILE KIT DE JONCTION LINEAIRE



CODE RÉFÉRENCE	PACK Pcs. EMB. Pcs.
DMA	1/10

COUPLING BETWEEN TWO TRUNKINGS PROFIL DE LIAISON LATÉRALE



CODE RÉFÉRENCE	PACK Pcs. EMB. Pcs.
DM050	10

END CAP/EMBOUIT DE FERMETURE



CODE RÉFÉRENCE	DIMENSIONS DIMENSIONS	PACK Pcs. EMB. Pcs.
DMTR10	100	20
DMTR15	150	20
DMTR20	200	20

CABLE SEPARATOR/SÉPARATEUR



CODE RÉFÉRENCE	LENGTH m LONGUEUR m	PACK m EMB. m
LDS50	1	50

CROSS ARM FOR CABLES AND SEPARATORS RETENTION AGRAPHÉ



CODE RÉFÉRENCE	DIMENSIONS DIMENSIONS	PACK Pcs. EMB. Pcs.
DMT10	100	10
DMT15	150	10
DMT20	250	10

CABLE-TIE HOLDER/FIXE COLLIER



CODE RÉFÉRENCE	PACK Pcs. EMB. Pcs.
DMF	100

CABLE TRUNKING SYSTEMS "TIPO G" LENGTH 2 m GOULOTTES DE DISTRIBUTION STANDARD "TIPO G" LONG. 2 m

SELF-EXTINGUISHING RIGID PVC CLASS 1, UL94-V0



CODE RÉFÉRENCE	DIMENSIONS (b x h) DIMENSIONS (b x h)	COLOUR COULEUR	PACK m EMB m
G50 (NEW)	250x70		8
G50BEU (NEW)	250x70		8

Wire ducts with built-in bottom rails. All trunkings are supplied complete with covers
Goulottes avec guide intégrée au fond. Toutes les goulottes sont fournies avec couvercles.

INSTALLATION TRUNKINGS/GOULOTTES D'INSTALLATION

CAVITY FLOOR SOCKET BOXES/BOÎTES DE SOL

CAVITY FLOOR SOCKET BOX HYPOGEO rev4.0/BOÎTE DE SOL HYPOGEO rev4.0

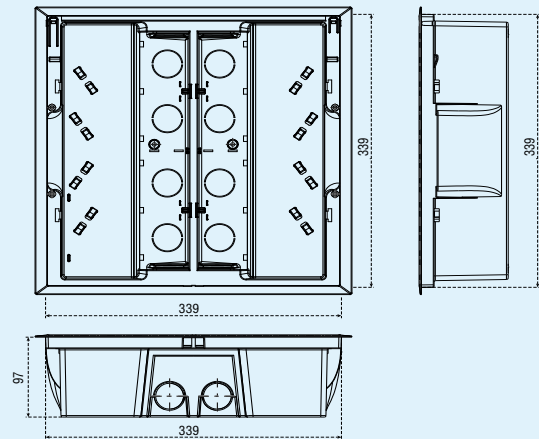

CODE RÉFÉRENCE	DIMENSIONS DIMENSIONS	MODULES MODULES	BOX COMPLETE WITH BOÎTE COMPLETE AVEC	COMPATIBILITY COMPATIBILITE	LID DEPTH EPAISSEUR DU COUVERCLE	PROTECTION PROTECTION	MAXIMUM LOAD CHARGE MAXIMUM	PACK Pcs. EMB. Pcs.
HYPO16	339x339x97	8x45mm 16x22,5mm	<ul style="list-style-type: none"> • 1 cover • 4 front plates 504 • 2-socket separators • 2 Cross arm • 1 couvercle • 4 chassis pour deux prises chacun • 2 cloisons pour separation des usages • 2 barrettes serre-cables 	<p>with the major international brands.</p> <p>Avec les principales marques d'appareillage électrique</p>	9mm	<ul style="list-style-type: none"> - IP52 between frame and floor (using gasket HG04) - IP4X between frame and cover - IP2X in correspondence with the cable outlet - IP52 entre l'encadrement et le plancher (avec joint hg04) - IP4X entre l'encadrement et le couvercle - IP2X a la sortie des cables 	<p>3000 N (uniformly distributed)</p> <p>3000 N (réparties uniformément)</p>	1

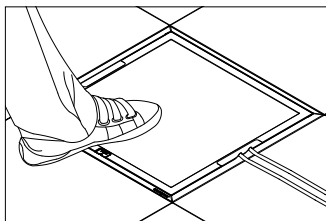
STRENGTH AND TIGHTNESS
TENUE ET FORCE

The exclusive central location of the inner equipment contributes to a better load resistance thus reducing the risk of breaking the cover./ L'exclusif emplacement central des prises, contribue a la plus grande resistance a la charge en diminuant le risque de rupture du couvercle.

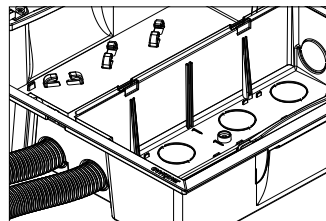
PRE-PUNCHED OPENINGS
COMPARTIMENTS D'ACCES

The knockouts located at the center on both sides and on the bottom of the box simplify the wiring of the sockets./ Les trous pre-decoupés situés au centre sur les deux cotés et sur le fond du boîtier simplifient les opérations de connexion des prises.

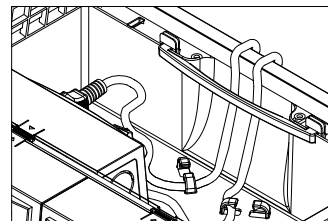
CABLE HOLDING
RETENUE DES CABLES

The two yellow cross-arms near the exit, and the clips located on the base of the box, allow a neat cable routing./ Les deux barres transversales jaunes près de la sortie et les clips de retenue situés sur la base du boîtier vous permettent d'ordonner et contenir les cables.

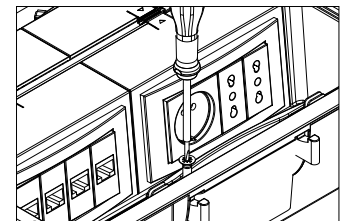
FLOOR FIXING
FIXATION AU SOL

The cavity floor tile fixing hooks are captive and self-positioning for quick installation and removal./ Les crochets de fixation a la tuile du plancher flottant sont imperdibles, auto-positionnants, d'installation et demontage rapides.

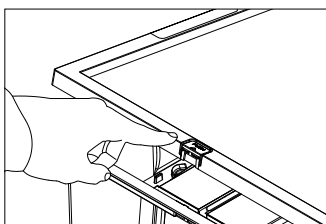
SNAP-ON COVER
COUVERCLE ENCLIQUETABLE

It is opened by pressing the releasable button located on the top of the box. No need of any tool./ Il s'ouvre par la poussee d'un bouton situe sur le sommet du boîtier. Pas besoin d'outils.

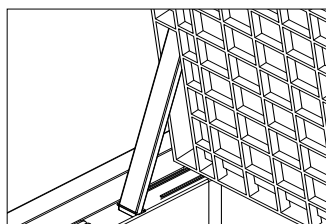
LID OPENING ROD
TIGE POUR COUVERCLE

In order to facilitate maintenance, Hypogeo rev4.0 is supplied with an easily removable rod to keep the lid raised./ Pour faciliter les opérations de maintenance, hypogeo rev4.0 Est accompagné par une tige facilement amovible pour maintenir le couvercle souleve.

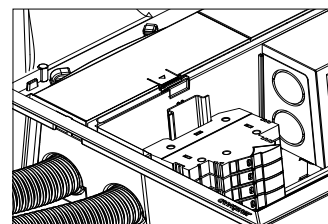
COMPATIBILITY
COMPATIBILITE

Inside of Hypogeo rev4.0 it is possible to house either sockets or din rail devices./ A l'interieur d'hypogeo rev4.0 On peut loger soit les prises et dispositifs pour rail din.

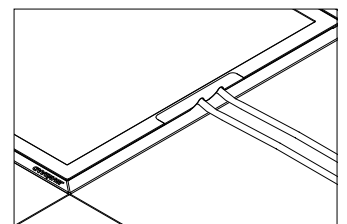
SOFT CABLE-PROTECTOR
PROTEGE-CABLE SOUPLE

To avoid the crushing and peeling of cables and to increase protection Hypogeo rev4.0 is fitted with special rubber protector./ Pour éviter d'écraser le cable et accroître la protection en caoutchouc special.

INSTALLATION TRUNKINGS/GOULOTTES D'INSTALLATION

CAVITY FLOOR SOCKET BOXES/BOÎTES DE SOL

CAVITY FLOOR SOCKET BOXES "HYPOGEO SMALL" AND "HYPOGEO" BOÎTES DE SOL "HYPOGEO SMALL" ET "HYPOGEO"



CODE RÉFÉRENCE	DIMENSIONS DIMENSIONS	COVER FINISHING FINITION DU COUVERCLE	PACK Pcs. EMB. Pcs.
HYOSM	227x250x120	--	1
HYOSM1	227x250x120	inox	1
HYOGE0	305x305x120	--	1
HYOGE01	305x305x120	inox	1

CENTRAL FRONT PLATES FOR 2 SCHUKO OR 4 ITALIAN MODULES CHASSIS 4 MODULES

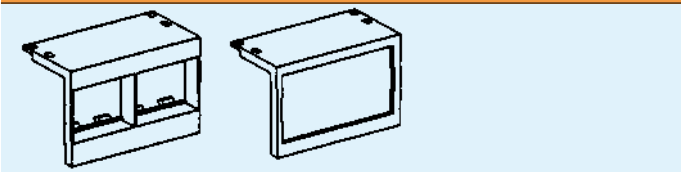

CODE RÉFÉRENCE	DESCRIPTION DESCRIPTION	COLOUR COULEUR	PACK Pcs. EMB. Pcs.
HG22 •	MOD. 503		12
HG48	TICINO TT Magic		12
HG38TIN*	TICINO International		12
HG25	AVE BLANC/NOIR		12
HG24	GEWISS Serie 20		12
HG43	VIMAR IDEA		12
HG45	LEGRAND MOSAIC 45		12

• compatible only with HYPOGEO and HYPOGEO1/compatible uniquement avec HYPOGEO et HYPOGEO1

* For CANALPLAST switches/ Pour interrupteurs CANALPLAST

LATERAL FRONT PLATES FOR 3 SCHUKO OR 6 ITALIAN MODULES CHASSIS 6 MODULES

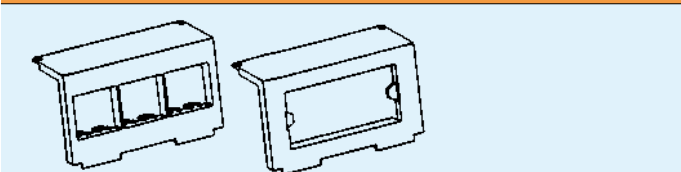

CODE RÉFÉRENCE	DESCRIPTION DESCRIPTION	COLOUR COULEUR	PACK Pcs. EMB. Pcs.
HG03 •	MOD. 504 - 2x MODULES		12
HG49 •	TICINO TT Magic		12
HG37TIN* •	TICINO International		12
HG18 •	AVE BLANC/NOIR		12
HG17 •	GEWISS Serie 20		12
HG33 •	VIMAR IDEA		12
HG44 •	LEGRAND MOSAIC 45		12

• compatible only with HYPOGEO et HYPOGEO1/Compatible uniquement avec HYPOGEO et HYPOGEO1

* For CANALPLAST switches/ Pour interrupteurs CANALPLAST

SINGLE FRONT PLATES/CHASSIS 1 MODULES

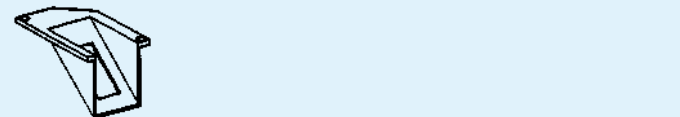

CODE RÉFÉRENCE	DESCRIPTION DESCRIPTION	COLOUR COULEUR	PACK Pcs. EMB. Pcs.
HG47	TICINO TT Magic		12
HG41TIN*	TICINO International		12
HG29	AVE BLANC/NOIR		12
HG28	GEWISS Serie 20		12
HG42	VIMAR IDEA		12
HG46	LEGRAND MOSAIC 45		12

* For CANALPLAST switches/ Pour interrupteurs CANALPLAST

COVER PROTECTION KIT FOR HYPOGEO KIT DE PROTECTION POUR COUVERCLE

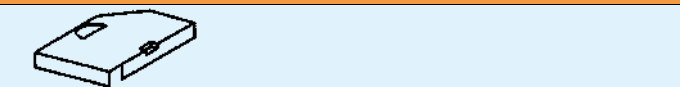

CODE RÉFÉRENCE	PACK Pcs. EMB. Pcs.
HG16	12 Kit

FRONT PLATES FOR BIPOLAR AUTOMATIC DIFFERENTIAL SWITCH CHASSIS POUR DISJONCTEURS

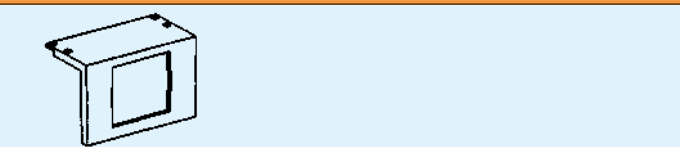

CODE RÉFÉRENCE	COLOUR COULEUR	PACK Pcs. EMB. Pcs.
HG50		6

PANEL FOR 2 CONNECTORS RJ45 CHASSIS POUR 2 CONNECTEURS FEMELLES RJ45 AT

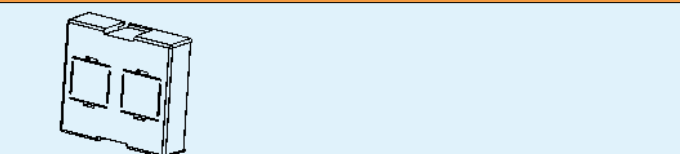

CODE RÉFÉRENCE	COLOUR COULEUR	PACK Pcs. EMB. Pcs.
HGATRJ		6

SOCKET UNIT SUPPORT CONNECTEURS SUPPORT

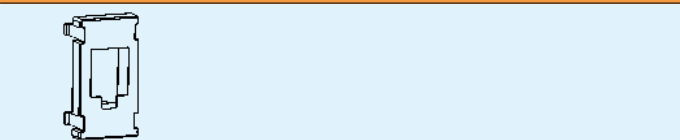



CODE RÉFÉRENCE	DESCRIPTION DESCRIPTION	COLOUR COULEUR	PACK Pcs. EMB. Pcs.
HGC5K	CAT.5 KRONE		12
HGC5P	CAT.5 PANDUIT		12

INSTALLATION TRUNKINGS/GOULOTTES D'INSTALLATION

CAVITY FLOOR SOCKET BOXES/BOÎTES DE SOL

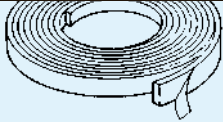
ADHESIVE GASKET FOR THE EDGE OF THE BOX JOINT ADHÉSIF



CODE RÉFÉRENCE	DIMENSIONS DIMENSIONS	COLOUR COULEUR	PACK Pcs. EMB. Pcs.
HG04	9 mm		10

OUTSIDE BOX FOR AUTOMATIC SWITCHES BOITE EXTERIEURE POUR DISJONCTEURS

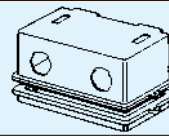

CODE RÉFÉRENCE	DIMENSIONS DIMENSIONS	MODULES MODULES	COLOUR COULEUR	PACK Pcs. EMB. Pcs.
HG13	150x85x60	Max 3		6

BOX IN PREGALVANIZED STEEL SHEET BOITE EN TÔLE PRÉ-GALVANISÉE

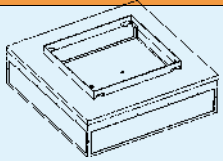





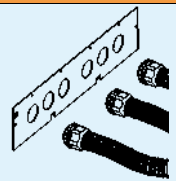

























CODE RÉFÉRENCE	DIMENSIONS DIMENSIONS	PACK Pcs. EMB. Pcs.
HG99SM	343x343x122	1

SIDES ADAPTOR FOR HOSES ADAPTATEUR LATÉRALE POUR TUYAUX



CODE RÉFÉRENCE	Ø	PACK Pcs. EMB. Pcs.
HG991	Max 28,5	2

SWITCHES - SOCKETS/INTERRUPTEURS - PRISES

CODE RÉFÉRENCE	DESCRIPTION DESCRIPTION	COLOUR COULEUR	PACK Pcs. EMB. Pcs.	CODE RÉFÉRENCE	DESCRIPTION DESCRIPTION	COLOUR COULEUR	PACK Pcs. EMB. Pcs.
 CP7600.1	1 gang switch 16A Disjoncteur unipolaire 16A		30	 CP7648D	Schuko 16A + grounding Prise shuko 16A +T C/ sécurité		15
 CP7601.6	2 way switch 16A déviateur 16A		30	 CP7664.C5	RJ45 voice-data socket 8P/8C - Cat.5 E Prise voix-données RJ45 8P/8C-CAT.5e		10
 CP7613.2	2 gang switch 16A Disjoncteur bipolaire 16A		30	 CP7664.C6	RJ45 voice-data socket 8P/8C - Cat.6 E Prise voix-données RJ45 8P/8C-CAT.6		10
 CP7614.10	Circuit breaker 1P+N10A 3kA Disjoncteur 1P+N10A 3kA		20	 CP7679	ITA. Shuttered Socket 2P-10/16A + grounding Prise sécurité 2P-10/16A+T		30
 CP7614.16	Circuit breaker 1P+N16A 3kA Disjoncteur 1P+N16A 3kA		20	 CP7688	False module Couvercle du trou		80
 CP7648.FR	French socket 16A + grounding Prise française +T sécurité		15	 CP7748.DS.R	Red Schuko 16A + grounding Prise shuko 16A+T SIC-S/Terre central		15
 CP7648.FR.R	French socket 16A + grounding Prise française +T sécurité		15	 CP7779.R	ITA. Shuttered Socket 2P-10/16A + grounding Prise sécurité 2P-10/16A+T		30
 CP7648.UK	UK socket 13A Prise britannique		15				

INSTALLATION TRUNKINGS/GOULOTTES D'INSTALLATION

FLOOR SOCKET-POINT TURRETS/COLONNES DE BUREAU

Triall

MONOLYTO



COLONNA
MONOLYTOFLOOR SOCKET-POINT TURRET "MONOLYTO"
PETITE COLONNE MONTANTE "MONOLYTO"

 -5° / +60° CONFORMING TO: LVD 2006/95/CE - EN 50085-2-4

CODE RÉFÉRENCE	DESCRIPTION	DIMENSIONS DIMENSIONS	COLOUR COULEUR	PACK Pcs. EMB. Pcs.
MONO1N	Single vertical turret Colonne simple, verticale	144x156x196	■	4
MONO1AL	Single vertical turret Colonne simple, verticale	144x156x196	■	4
MONO2N	Single horizontal turret Colonne simple, horizontale	188x156x169	■	4
MONO2AL	Single horizontal turret Colonne simple, horizontale	188x156x169	■	4

■ = colour aluminium/ couleur aluminium

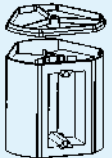
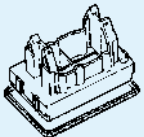
ACCESSORIES MONOLYTO/ACCESSOIRES POUR MONOLYTO

CODE RÉFÉRENCE	DESCRIPTION DESCRIPTION	COLOUR COULEUR	PACK Pcs. EMB. Pcs.
 MONO11N	Body for vertical turret Corps pour colonne verticale	■	1
	Body for vertical turret Corps pour colonne verticale	■	1
 MONO21N	Base for horizontal turret Base pour colonne horizontale	■	4
	Base for horizontal turret Base pour colonne horizontale	■	4
 VPGTC4INT	Kit for bipolar mcbs Plaquette pour le disjoncteur	■	27





COLUMN FOR ELECTRICAL, TELEPHONE
AND AUXILIARY SERVICE - "MONOLYTO COLONNA"
COLONNE DE BUREAU, TÉLÉPHONIES ET AUXILIAIRES
"MONOLYTO COLONNA"

 -5° / +60° CONFORMING TO: LVD 2006/95/CE - EN 50085-2-4



CODE RÉFÉRENCE	DIMENSIONS (H) DIMENSIONS (H)	COLOUR COULEUR	PACK Pcs. EMB. Pcs.
MONOA1AL	295	■	1

■ = colour aluminium/ couleur aluminium

ACCESSORIES MONOLYTO COLONNA
ACCESSOIRES ET COMPOSANTS POUR "MONOLYTO COLONNA"

CODE RÉFÉRENCE	DESCRIPTION DESCRIPTION	COLOUR COULEUR	PACK Pcs. EMB. Pcs.
 MONO11N	Body for vertical turret Corps pour colonne verticale	■	1
	Body for vertical turret Corps pour colonne verticale	■	1
 MONO22N	Cover + base Couvercle et base de colonne	■	2
 VPGTC4INT	Kit for bipolar mcbs Plaquette pour le disjoncteur	■	27
 MONO10N	Monolyto main part with joint Extension et joint de colonne	■	2
 MOBF665	Threaded bar M8x665 mm + M8 nuts Tige filetée	■	2

SOCKET POINTS COLUMN TRIALL/COLONNE DE BUREAU TRIALL



CODE RÉFÉRENCE	DESCRIPTION DESCRIPTION	DIM. (H) DIM. (H)	COLOUR COULEUR	PACK Pcs. EMB. Pcs.
TRIAL280PV	Column/ Colonne	3000	■	1
TRIAL280	Column/ Colonne	3000	■	1
TRIALPRPV	Central body/Extension	930	■	1
TRIALPRO	Central body/Extension	930	■	1

■ = colour aluminium/ couleur aluminium

ACCESSORIES TRIALL/ACCESSOIRES POUR TRIALL

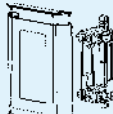
CODE RÉFÉRENCE	DESCRIPTION DESCRIPTION	COLOUR COULEUR	PACK Pcs. EMB. Pcs.
 TRIPP10	Front plates for socket. Wheelbase 108 Cadre pour mécanismes interaxe 108	■	2
	Cover for autom. differential switches Plaquette pour le disjoncteur	■	2



AIR CONDITIONING INSTALLATION

- ▶ AIR CONDITIONING DUCTS
- ▶ CONDENSATION DRAIN ACCESSORIES
- ▶ BASES AND BRACKETS

GOULOTTES DE CLIMATISATION

- ▶ SYSTÈME DE GOULOTTES POUR L'AIR CONDITIONNÉ
- ▶ ACCESSOIRES DE VIDANGE CONDENSATION
- ▶ BASES ET SUPPORTS

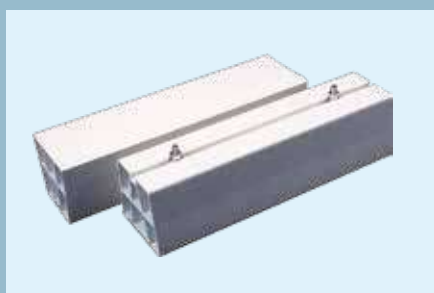
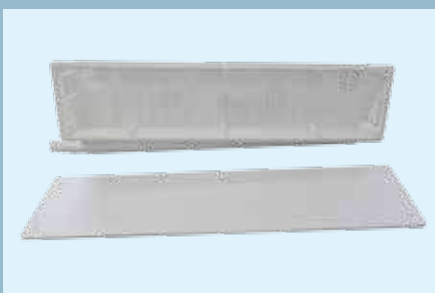
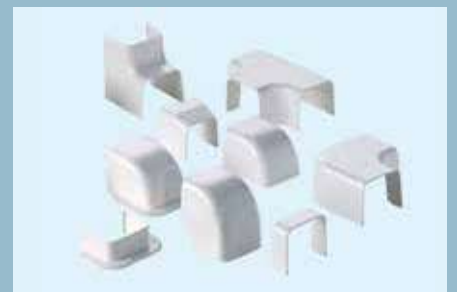
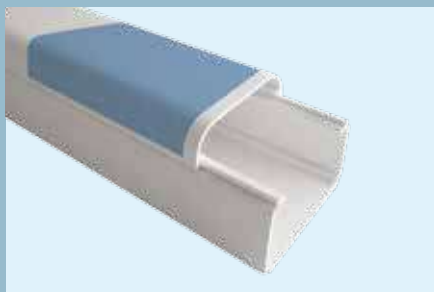
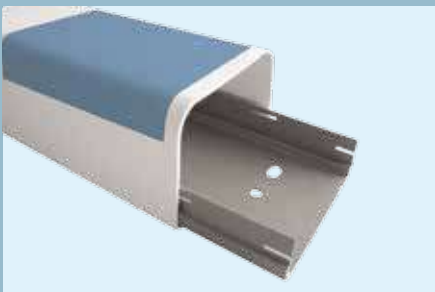

AIR CONDITIONING INSTALLATION/GOULOTTES DE CLIMATISATION

AIR CONDITIONING DUCTS/SYSTÈME DE GOULOTTES POUR L'AIR CONDITIONNÉ

TRUNKINGS WITH WRAP-AROUND COVER WITH PROTECTIVE FILM - COLOUR WHITE - LENGTH 2 m
GOULOTTES ENVELOPPANTE AVEC FILM DE PROTECTION - COULEUR BLANC - LONGUEUR 2 m

SELF-EXTINGUISHING UL94-V0



CODE RÉFÉRENCE	DIMENSIONS (b x h) DIMENSIONS (b x h)	PACK m EMB. m
CON65A	65x50	24
CON70A	70x55	20
CON80A	80x60	16
CON90A	90x65	16
CON125A	125x75	8

TRUNKING WITH SNAP-ON COVER WITH PROTECTIVE FILM COLOUR WHITE - LENGTH 2 m
GOULOTTE À DÉCLIC MUNIS DE FILM DE PROTECTION COULEUR BLANC - LONGUEUR 2 m

PC AM50



CODE RÉFÉRENCE	DIMENSIONS (b x h) DIMENSIONS (b x h)	PACK m EMB. m
CON30*	35x30	64
CON65 (NEW)	65x50	28
CON70	70x55	24
CON80 (NEW)	80x60	20
CON90	90x65	16
CON125	125x75	8

* Without protective film/sans film de protection

COVER JOINT

JOINT DE COUVERCLE



CODE RÉFÉRENCE	FOR TRUNKING POUR GOULOTTE	PACK Pcs. EMB. Pcs.
CONG30	35x30	25
CONG65	65x50	25
CONG70	70x55	25
CONG80	80x60	25
CONG90	90x65	25
CONG125	125x75	25

INNER BEND
ANGLE INTERNE

CODE RÉFÉRENCE	FOR TRUNKING POUR GOULOTTE	PACK Pcs. EMB. Pcs.
CONAI30	35x30	20
CONAI65	65x50	10
CONAI70	70x55	10
CONAI80	80x60	10
CONAI90	90x65	10
CONAI125	125x75	10

OUTER BEND
ANGLE EXTÉRIEUR

CODE RÉFÉRENCE	FOR TRUNKING POUR GOULOTTE	PACK Pcs. EMB. Pcs.
CONAE30	35x30	20
CONAE65	65x50	10
CONAE70	70x55	10
CONAE80	80x60	10
CONAE90	90x65	10
CONAE125	125x75	10

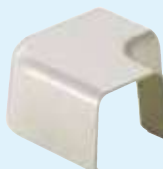
90° FLAT BEND
COURBE PLANE

CODE RÉFÉRENCE	FOR TRUNKING POUR GOULOTTE	PACK Pcs. EMB. Pcs.
CONCP30	35x30	20
CONCP65	65x50	10
CONCP70	70x55	10
CONCP80	80x60	10
CONCP90	90x65	10
CONCP125	125x75	10

AIR CONDITIONING INSTALLATION/GOULOTTES DE CLIMATISATION

AIR CONDITIONING DUCTS/SYSTÈME DE GOULOTTES POUR L'AIR CONDITIONNÉ

END CAP EMBOU



CODE RÉFÉRENCE	FOR TRUNKING POUR GOULOTTE	PACK Pcs. EMB. Pcs.
CONTP30	35x30	20
CONTP65	65x50	10
CONTP70	70x55	10
CONTP80	80x60	10
CONTP90	90x65	10
CONTP125	125x75	10

WALL ROUTING PASSAGE À MUR



CODE RÉFÉRENCE	FOR TRUNKING POUR GOULOTTE	PACK Pcs. EMB. Pcs.
CONPAM65	65x50	10
CONPAM70	70x55	10
CONPAM80	80x60	10
CONPAM90	90x65	10
CONPAM125	125x75	10

WALL-ROUTING BEND COURBE DE PASSAGE À PAROI



CODE RÉFÉRENCE	FOR TRUNKING POUR GOULOTTE	PACK Pcs. EMB. Pcs.
CONCM65	65x50	10
CONCM70	70x55	10
CONCM80	80x60	10
CONCM90	90x65	10
CONCM125	125x75	10

T-JOINT DEVIATION DÉRIVATION EN "T"



CODE RÉFÉRENCE	FOR TRUNKING POUR GOULOTTE	PACK Pcs. EMB. Pcs.
CONCT80	80x60	6
CONCT90	90x65	6
CONCT125	125x75	6

JOINT WITH GASKET JOINT AVEC GUARNITURE



CODE RÉFÉRENCE	FOR TRUNKING POUR GOULOTTE	PACK Pcs. EMB. Pcs.
CONGU65	65x50	10
CONGU70	70x55	10
CONGU80	80x60	10
CONGU90	90x65	10

TRUNKING REDUCTION RÉDUCTION DE GOULOTTE



CODE RÉFÉRENCE	FOR TRUNKING POUR GOULOTTE	USE FEAT UTILIZER AVEC	PACK Pcs. EMB. Pcs.
CONRD90	90x65 - 70x55	CONG90	10
CONRD125	125x65 - 90x65	CONG125	10

FLANGE ACCESSORY ACCESSOIRE CONVOYEUR

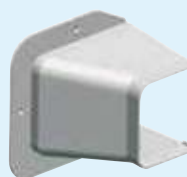

CODE RÉFÉRENCE	FOR TRUNKING POUR GOULOTTE	PACK Pcs. EMB. Pcs.
CONVG110-90	90x65 (and 70x55 using CONRD90/et 70x55 à l'aide de CONRD90)	8

AIR CONDITIONING INSTALLATION/GOULOTTES DE CLIMATISATION

AIR CONDITIONING DUCTS/SYSTÈME DE GOULOTTES POUR L'AIR CONDITIONNÉ

**CROSS-ARM WITH HOSE CLIP
FOR TRUNKING WITH SNAP-ON COVER**
TRAVERSE AILES FERME-TUYAU POUR GOULOTTE A DÉCLIC

CODE RÉFÉRENCE	FOR TRUNKING POUR GOULOTTE	PACK Pcs. EMB. Pcs.
CONTR65TB	65x50	25
CONTR70TB	70x55	25
CONTR80TB	80x60	25
CONTR90TB	90x65	25
CONTR125TB	125x75	25

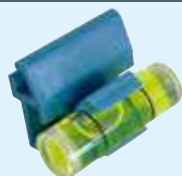
**SPIRIT LEVEL HOLDER + SPIRIT LEVEL SET
FOR TRUNKING WITH SNAP-ON COVER**
JEUX PORTE-NIVELLE + BULLE POUR GOULOTTE A DÉCLIN

CODE RÉFÉRENCE	FOR TRUNKING POUR GOULOTTE	PACK Pcs. EMB. Pcs.
CONPTB	universal	50 (5x10)

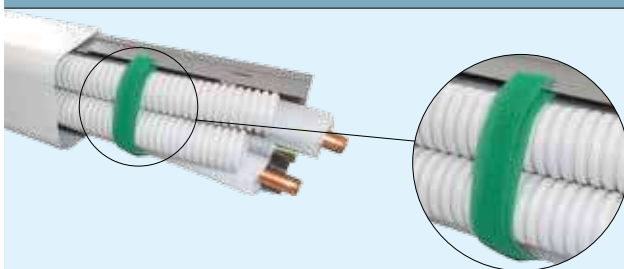
**GREEN VELCRO STRIP FOR TRUNKING
WITH WRAP-AROUND COVER 10 X 5 MM**
BANDE VELCRO VERT
POUR GOULOTTE ENVELOPPANTE 10 X 5 mm

CODE RÉFÉRENCE	FOR TRUNKING POUR GOULOTTE	PACK Pcs. EMB. Pcs.
VLC10V	65x50 - 70x55 - 80x60 - 90x65 - 125x75	5

AIR CONDITIONING INSTALLATION/GOULOTTES DE CLIMATISATION

CONDENSATION DRAIN ACCESSORIES/ACCESSOIRES DE VIDANGE CONDENSATION

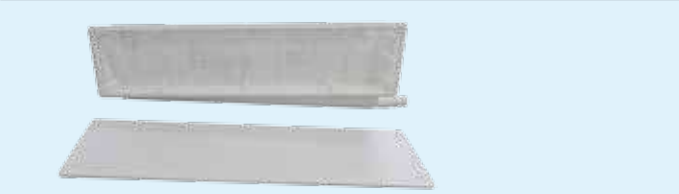
MODULAR BOX FOR CONDENSATION DRAIN
BOÎTIER MODULAIRE POUR LA VIDANGE DU CONDENSAT

CODE RÉFÉRENCE	DIMENSIONS DIMENSIONS	PACK Pcs. EMB. Pcs.
CONBOX	530x113 x65	20
CONBOX430	427x113x65	20

Box designed for assembly with horizontal condensate drain which can be positioned either on the right or left.
Boîte à drainer, intégrée et positionnable vers la droite ou vers la gauche.

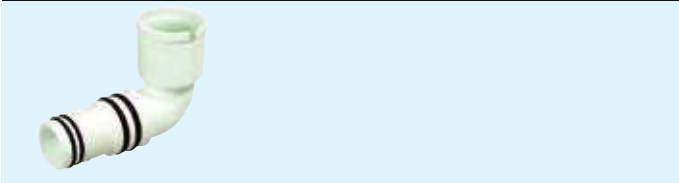
90° CONNECTION DRAIN
RACCORD DE VIDANGE À 90°

CODE RÉFÉRENCE	DIMENSIONS DIMENSIONS	PACK Pcs. EMB. Pcs.
CONBOXRC	Ø 16/18/20	48

90° for a vertical drain to be attached to the modular box.
90° pour la sortie de refoulement vertical à appliquer à la boîte modulaire.

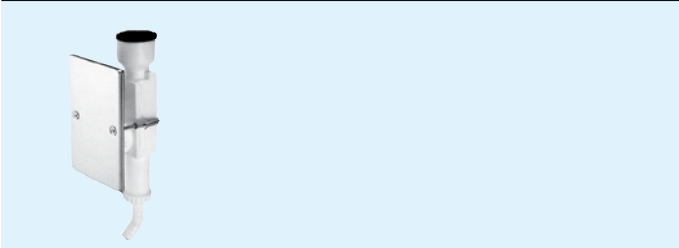
VERTICAL CONDENSATION DRAIN SIPHON ANTI-ODOR
SIPHON VERTICAL DE DÉCHARGE DU COND. ANTI-ODEUR

CODE RÉFÉRENCE	DESCRIPTION DESCRIPTION	PACK Pcs. EMB. Pcs.
CONSSC146	without fastening plate sans plaque de fixation	50
CONSSCP146	with fastening plate avec plaque de fixation	50

HORIZONTAL CONDENSATION DRAIN SIPHON ANTI-ODOR
SIPHON HORIZ. DE DÉCHARGE DU COND. ANTI-ODEUR

CODE RÉFÉRENCE	DIMENSIONS DIMENSIONS	PACK Pcs. EMB. Pcs.
CONSSCU	60x77x50 mm	50

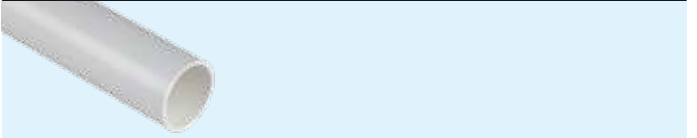
CONDENSATION DRAIN PIPE
TUYAU D'ÉVACUATION DES CONDENSATS

CODE RÉFÉRENCE	Ø	PACK m EMB. m
CONTUR20	20	20
CONTUR25	25	20
CONTUR32	32	20

45° BEND/COUDE À 45°

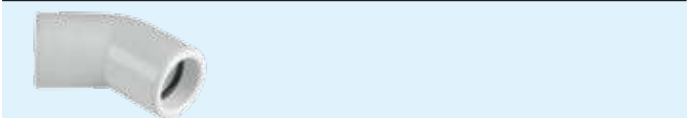

CODE RÉFÉRENCE	Ø	PACK Pcs. EMB. Pcs.
CONTURG4520	20	20
CONTURG4525	25	20
CONTURG4532	32	20

90° BEND/COUDE À 90°

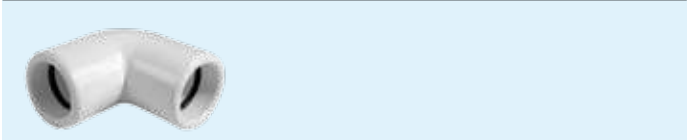

CODE RÉFÉRENCE	Ø	PACK Pcs. EMB. Pcs.
CONTURG9020	20	20
CONTURG9025	25	20
CONTURG9032	32	20

SLEEVE JOINT/MANCHON DE JONCTION

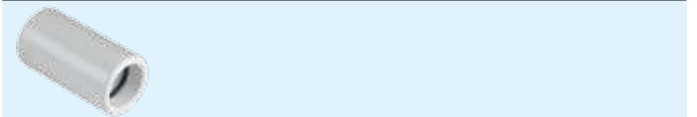

CODE RÉFÉRENCE	Ø	PACK Pcs. EMB. Pcs.
CONTURM20	20	20
CONTURM25	25	20
CONTURM32	32	20

"T" DEVIATION/DÉRIVATION EN "T"



CODE RÉFÉRENCE	Ø	PACK Pcs. EMB. Pcs.
CONTURT20	20	20
CONTURT25	25	20
CONTURT32	32	20

AIR CONDITIONING INSTALLATION/GOULOTTES DE CLIMATISATION

CONDENSATION DRAIN ACCESSORIES/ACCESSOIRES DE VIDANGE CONDENSATION

PIPE REDUCTION/RÉDUCTION DANS LE TUYAU



CODE RÉFÉRENCE	Ø	PACK Pcs. EMB. Pcs.
CONTURR2520	25-20	20
CONTURR3225	32-25	20

FOR PIPE FASTENING/POUR MONTAGE SUR TUBE



CODE RÉFÉRENCE	Ø	PACK Pcs. EMB. Pcs.
CONTURC20	20	20
CONTURC25	25	20
CONTURC32	32	20

HOSE SHEATH FOR DRAIN CONDENSATION
GUAINE-TUYAU POUR VIDANGE EAU DE CONDENSATION

CODE RÉFÉRENCE	Ø	PACK m EMB. m
CONFLBI116	16	25
CONFLBI118	18	25
CONFLBI120	20	25

Plastic coated self-extinguishing PVC with anti-crush spiral. The smooth interior avoids any stagnation of the condensation. Recommended for external use and NOT subtrack.
Tuyau en PVC plastifié autoextinguible avec spirale antiécrasement. La paroi intérieure lisse évite la stagnation de la condensation. Recommandé pour une utilisation en extérieur et ne pas sous paroi.

BOX-HOSE DRAIN CONNECTION JOINT
RACCORD DE DÉCHARGE BOÎTE-TUYAU

CODE RÉFÉRENCE	DIMENSIONS DIMENSIONS	PACK Pcs. EMB. Pcs.
CONRACCT1620	16x20	30

ANTI-CONDENSATION TAPE
BANDE ANTI-CONDENSATION

CODE RÉFÉRENCE	DIMENSIONS DIMENSIONS	PACK Pcs. EMB. Pcs.
CONISOGM	50x3 - 10 m	24
CONISOPL	50x3 - 10 m	24

Material: Rubber = GM Polyethylene = PL
Range of use: -15°C/+80°C. - Class 1 fire reaction.
Material: polyethylene = PL, caoutchouc = GM
Gamme de température: -15° C / +80° C - Réaction au feu classe 1.

CORRUGATED HOSE FOR CONDENSATION
TUYAU D'ÉVACUATION DE CONDENSANT ONDULÉ

CODE RÉFÉRENCE	Ø	PACK m EMB. m
CONFLEX18.20	16/18/20	50

PELD Corrugated pipe Ø 16-18-20 mm. UV stabilized. Equipped with male-female junction per meter - alternating diameter 16-18 and 18-20 mm.

Tuyau PELD ondulé Ø 16-18-20 mm. contre les UV. Equipé de mâle-femelle jonction par mètre - diamètre alternant 16-18 et 18-20 mm.

THREE-WAY FITTING FOR CORRUGATE HOSE
RACCORD À TROIS VOIES POUR TUYAU FLEXIBLE

CODE RÉFÉRENCE	Ø	PACK Pcs. EMB. Pcs.
CONRAC283	16/18/20	50

With multi-split systems. Conveys the drain of two machines to single piping.
Avec les systèmes multi-split. Mène les égouts des deux machines à un seul.

"Y" DRAIN CONNECTION FOR CORRUGATE HOSE
RACCORD DE VIDANGE EN "Y" POUR TUYAU FLEXIBLE

CODE RÉFÉRENCE	Ø	PACK Pcs. EMB. Pcs.
CONRACY1618	16/18	10
CONRACY1820	18/20	10

"T" JOINT DEVIATION FOR CORRUGATE HOSE
RACCORD DE VIDANGE EN "T" POUR TUYAU FLEXIBLE

CODE RÉFÉRENCE	Ø	PACK Pcs. EMB. Pcs.
CONRACCT1618	16/18	10
CONRACCT1820	18/20	10

AIR CONDITIONING INSTALLATION/GOULOTTES DE CLIMATISATION

BASES AND BRACKETS/BASES ET SUPPORTS

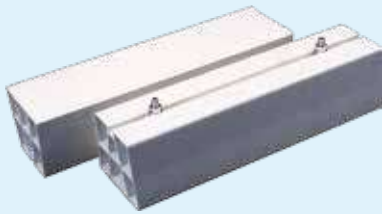
FLOOR SUPPORT - EXTERNAL SECTION
BASE À PLANC. - UNITÉ EXTÉRIEURENEW
NOUVELLES

CODE RÉFÉRENCE	DESCRIPTION DESCRIPTION	DIMENSIONS DIMENSIONS	PACK Pcs. EMB. Pcs.
CONBASE35N	PVC evolution - With slip resistant surface coextruded. Without support cap.	350x84x80	12
CONBASE45N	PVC evolution - Avec antidérapant coextrudé sur le fond. Sans bouchons.	450x84x80	12
CONBASE100N		1000x84x80	12

FLOOR BASES
BASES SUR LE SOL

CODE RÉFÉRENCE	DESCRIPTION DESCRIPTION	DIMENSIONS DIMENSIONS	PACK Pcs. EMB. Pcs.
CONBASE	In polypropylene - Resistant to UV rays and to high temperatures. En polypropylène - Résistant aux rayons UV et à des temp. élevées.	420x120x72,5	2

COUPLE OF SIMPLE WALL BRACKETS
PAIRE DE CONSOLES SIMPLESNEW
NOUVELLES

CODE RÉFÉRENCE	DESCRIPTION DESCRIPTION	DIMENSIONS DIMENSIONS	MAX LOAD Kg CHARGE MAX kg	PACK Pcs. EMB. Pcs.
CONSTPAR42EVO	TÜV	420x400	60+60	1 couple
CONSTPAR46EVOP	TÜV preassembled/ préassemblé	465x400	80+80	1 couple

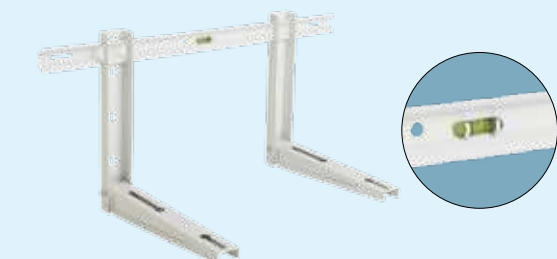
ADJUSTABLE UNIVERSAL BRACKET
SUPPORT UNIVERSEL RÉGLABLENEW
NOUVELLES

CODE RÉFÉRENCE	DESCRIPTION DESCRIPTION	DIMENSIONS DIMENSIONS	MAX LOAD Kg CHARGE MAX kg	PACK Pcs. EMB. Pcs.
CONSTUN42EVO	TÜV level / niveau	420x400x780	60+60	1

ADJUSTABLE UNIVERSAL BRACKET PREASSEMBLED
SUPPORT UNIVERSEL RÉGLABLE PRÉ-MONTÉNEW
NOUVELLES

CODE RÉFÉRENCE	DESCRIPTION DESCRIPTION	DIMENSIONS DIMENSIONS	MAX LOAD Kg CHARGE MAX kg	PACK Pcs. EMB. Pcs.
CONSTUN46EVOP	TÜV level / niveau	465x400x780	80+80	1
CONSTUN56EVOP	TÜV level / niveau	560x400x800	80+80	1

ADJUSTABLE UNIVERSAL BRACKET
SUPPORT UNIVERSEL RÉGLABLENEW
NOUVELLES

CODE RÉFÉRENCE	DESCRIPTION DESCRIPTION	DIMENSIONS DIMENSIONS	MAX LOAD Kg CHARGE MAX kg	PACK Pcs. EMB. Pcs.
CONSTUN48PLUS	TÜV	480x400x800	80+80	1

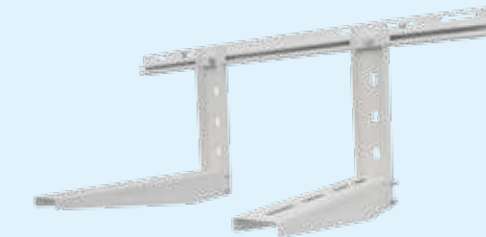
ADJUSTABLE UNIVERSAL BRACKET
SUPPORT UNIVERSEL RÉGLABLENEW
NOUVELLES

CODE RÉFÉRENCE	DESCRIPTION DESCRIPTION	DIMENSIONS DIMENSIONS	MAX LOAD Kg CHARGE MAX kg	PACK Pcs. EMB. Pcs.
CONSTUN56PLUS	TÜV	560x400x960	150+150	1

ANTI-VIBRATION KIT
KIT ANTI-VIBRATION

CODE RÉFÉRENCE	DIMENSIONS DIMENSIONS	MAX LOAD Kg CHARGE MAX kg	PACK Pcs. EMB. Pcs.
CONAVM30	30x20	42	10 kit (10x4)
CONAVM53	40x40	65	10 kit (10x4)

AIR CONDITIONING INSTALLATION/GOULOTTES DE CLIMATISATION

BASES AND BRACKETS/BASES ET SUPPORTS

ANTI-VIBRATION KIT

KIT ANTI-VIBRATION



CODE RÉFÉRENCE	DIMENSIONS DIMENSIONS	MAX LOAD Kg CHARGE MAX kg	PACK Pcs. EMB. Pcs.
CONAVP20	48x20	45	10 kit (10x4)

ANTI-VIBRATION KIT

KIT ANTI-VIBRATION



CODE RÉFÉRENCE	DIMENSIONS DIMENSIONS	MAX LOAD Kg CHARGE MAX kg	PACK Pcs. EMB. Pcs.
CONAVP53	40x40	65	10 kit (10x4)

COVERING GARMENT

CAPOT



CODE RÉFÉRENCE	DIMENSIONS DIMENSIONS	PACK Pcs. EMB. Pcs.
CONCAP725	700x265x540	10
CONCAP825	800x265x540	10
CONCAP836	860x330x610	10
CONCAP936	950x330x610	10
CONCAP937	950x380x750	10



ELECTRICAL EQUIPMENT INSTALLATION

- FLUSH JUNCTION BOXES
- JUNCTION BOXES FOR WALL MOUNTING
- FLUSH AND WALL DISTRIBUTION BOARDS
- CIRCUIT BREAKERS AND FUSE HOLDERS
- FITTINGS, FASTENINGS, CONNECTORS AND ACCESSORIES
- FISHTAPES AND HOSES

MATÉRIEL ÉLECTRIQUE D'INSTALLATION

- BOÎTES D'ENCASTREMENT
- BOÎTES DE DÉRIVATION A ENCASTRER
- COFFRETS DE DISTRIBUTION
- DISJONCTEURS, BLOCS DIFFÉRENTIELS ET COUPE CIRCUIT
- MANCHONS, B. DE CONNEXIONS ET ACCESS. DE FIXATION
- TIRE FILS ET GAINES



ELECTRICAL EQUIPMENT INSTALLATION / MATÉRIEL ÉLECTRIQUE D'INSTALLATION

FLUSH JUNCTION BOXES / BOÎTES D'ENCASTREMENT

BOXES: SINGLE-PACKED IN THERMORETRACTABLE FILM
BOÎTES À ENCASTRER EMBALLAGE INDIVIDUEL

HALOGEN FREE SANS HALOGENES	IP 40			TB 70 °C	GWT 650 °C	CEI 23-74 - CEI EN 60670-1 DIRECTIVE LVD 2006/95/CE	UL94-HB
---------------------------------------	-------	--	--	-------------	---------------	--	---------



CODE RÉFÉRENCE	DIMENSIONS DIMENSIONS	PACK Pcs. EMB. Pcs.
OL 10001	92x92x45	170
OL 10002	118x96x50	120
OL 10002/A	118x96x70	90
OL 10003	153x 98x70	70
OL 10004	160x130x70	44
OL 10005	196x152x70	40
OL 10006	294x152x70	24
OL 10007	392x152x70	20
OL 10008	480x160x70	12

ROUND BOXES WITH SCREWS

BOÎTES RONDES A ENCASTRER AVEC VIS

HALOGEN FREE SANS HALOGENES	IP 40			TB 70 °C	GWT 650 °C
---------------------------------------	-------	--	--	-------------	---------------



CODE RÉFÉRENCE	DIMENSIONS DIMENSIONS	DESCRIPTION DESCRIPTION	N. MOD. N. MOD.	PACK Pcs. EMB. Pcs.
OL 10031	60x40		2	100
OL 10032	110x65x45		3	180
OL 10034	60x40	without screw/sans vis	2	400
OL 10037	60x40	Modular/Modulaire	2	100

RECTANGULAR BOX LID WITH SCREWS - WHITE

COUVERCLE RECTANGULAIRE COMPLET AVEC VIS - BLANC

HALOGEN FREE SANS HALOGENES		TB 70 °C	GWT 650 °C
---------------------------------------	--	-------------	---------------



CODE RÉFÉRENCE	DIMENSIONS DIMENSIONS	BOX Pcs. COLIS Pcs.	PACK Pcs. EMB. Pcs.
OL 10041	92x92	5	100
OL 10042	118x96	5	160
OL 10043	153x98	5	140
OL 10044	160x130	5	80
OL 10045	196x152	5	60
OL 10046	294x152	2	40
OL 10047	392x152	2	30
OL 10048	480x160	2	24

MULTIPACK BOXES WITH LID AND SCREWS

BOÎTES À ENCASTRER EMBALLAGE EMPILÉ

HALOGEN FREE SANS HALOGENES	IP 40			TB 70 °C	GWT 650 °C	CEI 23-74 - CEI EN 60670-1 DIRECTIVE LVD 2006/95/CE	UL94-HB
---------------------------------------	-------	--	--	-------------	---------------	--	---------



CODE RÉFÉRENCE	DIMENSIONS DIMENSIONS	PACK Pcs. EMB. Pcs.
OL 10001*	92x 92x45	300
OL 10002*	118x 96x50	240
OL 10002A*	118x 96x70	145
OL 10003*	153x 98x70	80
OL 10004*	160x130x70	80
OL 10005*	196x152x70	60

* to order the product in boxes stacked add the code "M" ex: OL 10001M

* pour commander le produit dans des boîtes empilées ajouter le code "M". ex.: OL 10001M

ROUND BOX LID WITH FIXING CLIPS

COUVERCLE POUR BOÎTES RONDES

HALOGEN FREE SANS HALOGENES		TB 70 °C	GWT 650 °C
---------------------------------------	--	-------------	---------------



CODE RÉFÉRENCE	Ø	BOX Pcs. COLIS Pcs.	PACK Pcs. EMB. Pcs.
OL 10055	65	50	500
OL 10056	85	40	400

SEPARATORS FOR FLUSH-MOUNTING BOXES

CLOISON DE SEPARATION POUR BOÎTES

HALOGEN FREE SANS HALOGENES

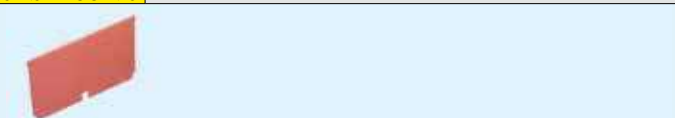

CODE RÉFÉRENCE	FOR ITEM PAR REF.	BOX Pcs. COLIS Pcs.	PACK Pcs. EMB. Pcs.
OL 10061	10005/6/7	25	200
OL 10062	10008	25	200

ELECTRICAL EQUIPMENT INSTALLATION / MATÉRIEL ÉLECTRIQUE D'INSTALLATION

FLUSH JUNCTION BOXES / BOÎTES D'ENCASTREMENT

FLUSH MOUNTING JUNCTION BOXES

BOÎTES À ENCASTRER AVEC ÉLÉMENTS

HALOGEN FREE
SANS HALOGENES

-5° / +60°
TB 70 °C GWT 650 °C

CEI 23-74 - CEI EN 60670-1
DIRECTIVE LVD 2006/95/CE



CODE RÉFÉRENCE	N. MOD. N. MOD.	DESCRIPTION DESCRIPTION	BOX Pcs. COLIS Pcs.	PACK Pcs. EMB. Pcs.
• OL 10084	4	119x63x57	-	100
• OL 10085	5	144x63x57	-	50
• OL 10090	3	97,5x62x50 mod. "LARGE"	12	300
• OL 10090*	3	97,5x62x50 multipack	-	340

• Items supplied upon request and for quantities be agreed also in yellow and blue colors. / Articles fournis sur demande et pour des quantités convenues dans les couleurs jaune et bleu.

* to order the product in boxes stacked add the code "M" ex.: OL 10090M. / Pour commander le produit dans des boîtes empilées ajouter le code "M". ex.: OL 10090M.

MORTAR PROTECTION

COUVERCLE DE PROTECTION

HALOGEN FREE
SANS HALOGENES



CODE RÉFÉRENCE	FOR ITEM PAR RÉFÉRENCE	PACK Pcs. EMB. Pcs.
OL 10100	OL 10090	120

COMBINATION JOINT

JOINT D'ASSEMBLAGE

HALOGEN FREE
SANS HALOGENES



CODE RÉFÉRENCE	FOR ITEM PAR RÉFÉRENCE	PACK Pcs. EMB. Pcs.
OL 10105	OL 10090	100

CARTON PROTECTION LID

COUVERCLE DE PROTECTION EN CARTON POUR MORTIER

HALOGEN FREE
SANS HALOGENES



CODE RÉFÉRENCE	FOR ITEM PAR RÉFÉRENCE	PACK Pcs. EMB. Pcs.
OL 10141	OL 10001	100 (5x20)
OL 10142	OL 10002 / OL 10002A	160 (5x32)
OL 10143	OL 10003	140 (5x28)
OL 10144	OL 10004	80 (5x16)
OL 10145	OL 10005	60 (5x12)
OL 10146	OL 10006	40 (2x20)
OL 10147	OL 10007	30 (2x15)
OL 10148	OL 10008	24 (2x12)

NEW
NOUVELLES

ITEMS SUPPLIED UPON REQUEST AND FOR QUANTITIES BE AGREED ALSO IN BLACK, YELLOW AND BLUE COLORS.

ARTICLES FOURNIS SUR DEMANDE ET POUR DES QUANTITÉS CONVENUES DANS LES COULEURS NOIR, JAUNE ET BLEU.



Separators/Cloisons



Guides on bottom for fitting terminal blocks ø 5
Fond avec guides predisposés pour le montage des bordières avec un trou de ø 5

Protection for boxes
Bouchon pour boîtes

ELECTRICAL EQUIPMENT INSTALLATION / MATÉRIEL ÉLECTRIQUE D'INSTALLATION

FLUSH JUNCTION BOXES - TECHNICAL DATA / BOÎTES D'ENCASTREMENT - CARACTÉRISTIQUES TECHNIQUES

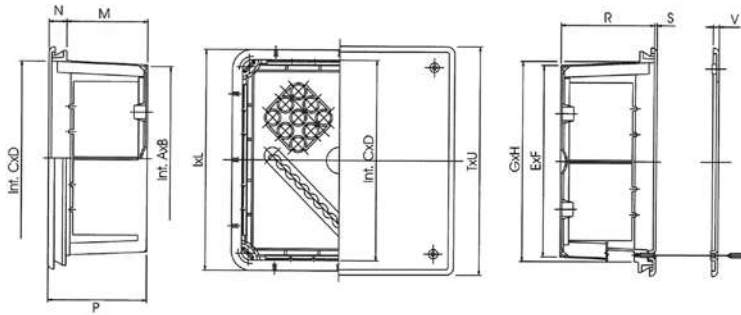

CODE	-A-	-B-	-C-	-D-	-E-	-F-	-G-	-H-	-I-	-L-	-M-	-N-	-P-	-R-	-S-	-T-	-U-	-V-
OL 10001	75	75	87	87	84	84	90	90	95	95	35	13	47	45	2	105	105	4,5

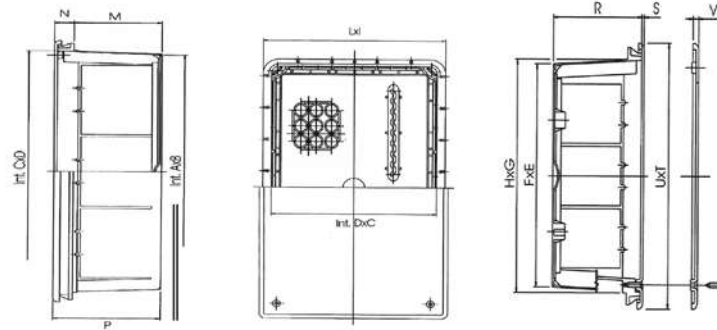

CODE	-A-	-B-	-C-	-D-	-E-	-F-	-G-	-H-	-I-	-L-	-M-	-N-	-P-	-R-	-S-	-T-	-U-	-V-
OL 10002	100	97	112	90	110	87	115	92	127	105	35	16	52	50	2	132	110	3,5
OL 10002A	100	97	112	90	110	87	115	92	127	105	55	16	72	70	2	132	110	3,5

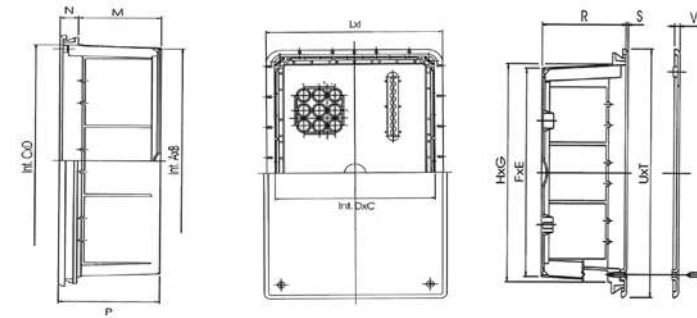

CODE	-A-	-B-	-C-	-D-	-E-	-F-	-G-	-H-	-I-	-L-	-M-	-N-	-P-	-R-	-S-	-T-	-U-	-V-
OL10003	133	80	145	92	140	87	148	95	162	108	60	13	72	70	2	165	111	4,5

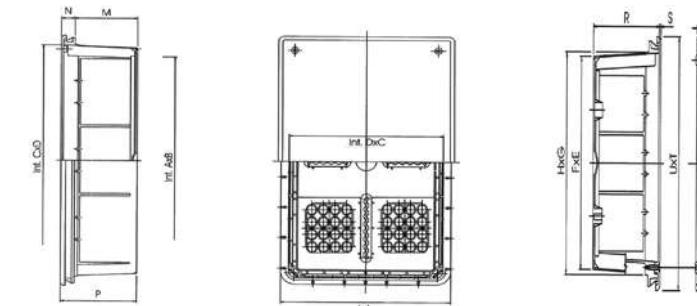

CODE	-A-	-B-	-C-	-D-	-E-	-F-	-G-	-H-	-I-	-L-	-M-	-N-	-P-	-R-	-S-	-T-	-U-	-V-
OL10004	142	113	155	125	152	120	160	128	172	140	60	13	72	70	2	175	145	4,5

ELECTRICAL EQUIPMENT INSTALLATION / MATÉRIEL ÉLECTRIQUE D'INSTALLATION

FLUSH JUNCTION BOXES - TECHNICAL DATA / BOÎTES D'ENCASTREMENT - CARACTÉRISTIQUES TECHNIQUES

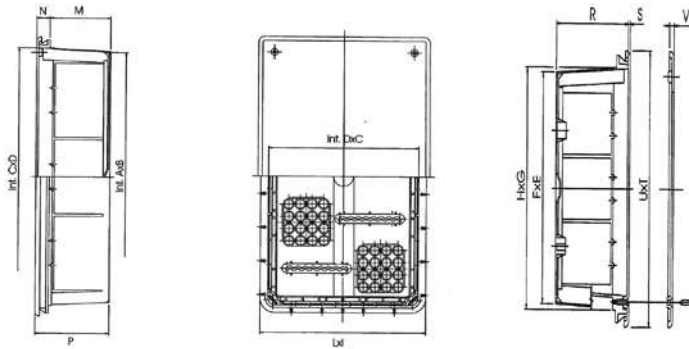

CODE	-A-	-B-	-C-	-D-	-E-	-F-	-G-	-H-	-I-	-L-	-M-	-N-	-P-	-R-	-S-	-T-	-U-	-V-	-Z-	-W-	-Y-
OL10005	175	132	190	145	183	140	190	145	205	160	60	13	72	70	2	210	167	130	178	65	4,5

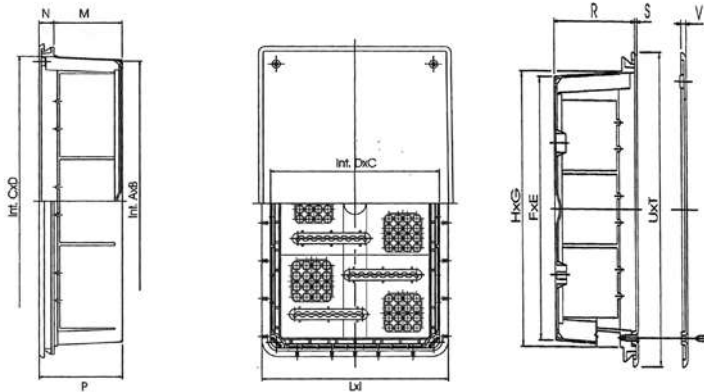

CODE	-A-	-B-	-C-	-D-	-E-	-F-	-G-	-H-	-I-	-L-	-M-	-N-	-P-	-R-	-S-	-T-	-U-	-V-	-Z-	-W-	-Y-
OL10006	274	132	287	145	281	139	284	146	300	160	60	13	72	70	2	310	167	130	178	65	5

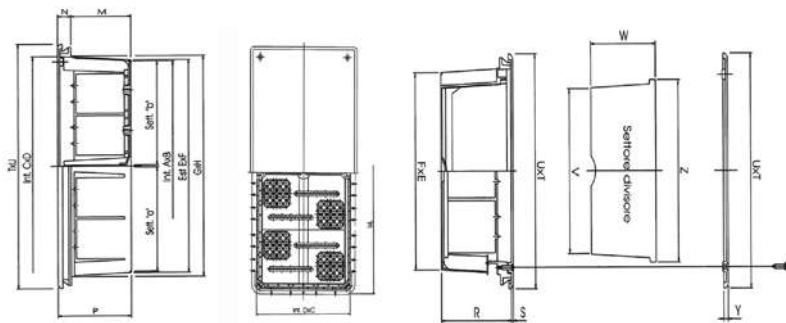

CODE	-A-	-B-	-C-	-D-	-E-	-F-	-G-	-H-	-I-	-L-	-M-	-N-	-P-	-R-	-S-	-T-	-U-	-V-	-Z-	-W-	-Y-
OL10007	370	132	383	145	377	140	380	145	395	160	60	13	72	70	2	405	167	130	178	65	5

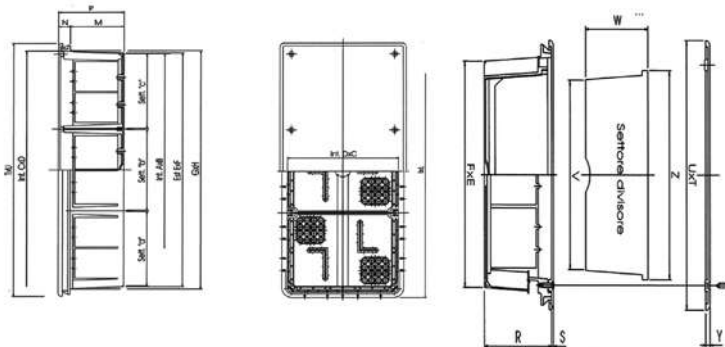

CODE	-A-	-B-	-C-	-D-	-E-	-F-	-G-	-H-	-I-	-L-	-M-	-N-	-P-	-R-	-S-	-T-	-U-	-V-	-Z-	-W-	-Y-
OL10008	461	140	475	153	468	147	470	155	485	165	60	13	72	70	2	495	175	137	185	65	4,5

ELECTRICAL EQUIPMENT INSTALLATION / MATÉRIEL ÉLECTRIQUE D'INSTALLATION

JUNCTION BOXES FOR WALL MOUNTING / BOÎTES DE DÉRIVATION

JUNCTION BOXES WITH ROUNDED PRESSURE LID
BOÎTES COUVERCLE CONVEXE Á PRESSION

TECHNOPOLYMER UL94HB		IP 44		-5°/+60°	TB 75 °C	GWT 650 °C	IK 07	CEI EN 60 670-1 CEI EN 60 670-22 Directive LVD 2006/95/CE
-------------------------	--	-------	--	----------	-------------	---------------	-------	---



CODE RÉFÉRENCE	DIMENSIONS DIMENSIONS	N. ENTRIES N. ENTRÉES	SCREW COVER BOUCHONS	PACK Pcs. EMB. Pcs.
• OL 20001	∅ 65x35	4	∅ 12	150 (30x5)
• OL 20002	∅ 80x40	4	∅ 12	160 (32x5)
• OL 20003	80x80x40	6	∅ 14	160 (32x5)
• OL 20006	80x80x40	6	∅ 14	160 (32x5)

- with membrane gland/avec passecables
- with knockouts/avec parois prétrouée

* For a double and complete insulation use plastic screw cover (p. 61)/Double et complète isolation en utilisant les bouchons (p. 61)

J. BOXES WITH MEMBRANE GLAND AND FLAT PRESSURE LID
BOÎTES COUVERCLE PLAT A PRESSION - ET PASSECABLES

TECHNOPOLYMER UL94HB		IP 55		-15°/+60°	TB 75 °C	GWT 650 °C	IK 07	CEI EN 60 670-1 CEI EN 60 670-22 Directive LVD 2006/95/CE
-------------------------	--	-------	--	-----------	-------------	---------------	-------	---

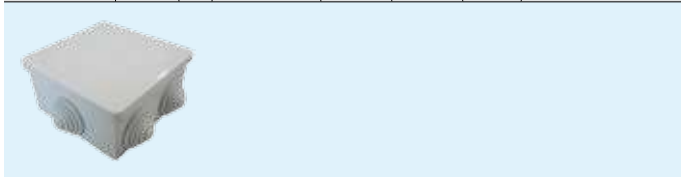

CODE RÉFÉRENCE	DIMENSIONS DIMENSIONS	N. ENTRIES N. ENTRÉES	SCREW COVER BOUCHONS	PACK Pcs. EMB. Pcs.
OL 20009	80x80x40	6	∅ 16	160 (32x5)

* For a double and complete insulation use plastic screw cover (p. 61)/Double et complète isolation en utilisant les bouchons (p. 61)

SMOOTH-SIDED JUNCTION BOXES QUICK FIXING 1/4 TURN
BOÎTES PAROIS LISSES AVEC COUVERCLE ET VIS 1/4 DE TOUR

TECHNOPOLYMER UL94HB		IP 56		-15°/+60°	TB 75 °C	GWT 650 °C	IK 07	CEI EN 60 670-1 CEI EN 60 670-22 Directive LVD 2006/95/CE
-------------------------	--	-------	--	-----------	-------------	---------------	-------	---

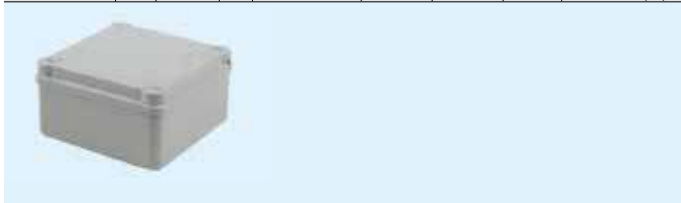

CODE RÉFÉRENCE	DIMENSIONS DIMENSIONS	SCREW COVER BOUCHONS	PACK Pcs. EMB. Pcs.
OL 20070	105x105x50	∅ 15	96
OL 20122	150x110x70	∅ 16	45

* For a double and complete insulation use plastic screw cover (p. 61)/Double et complète isolation en utilisant les bouchons (p. 61)

SMOOTH-SIDED J. BOXES WITH QUICK FIXING 1/4 TURN
BOÎTES COUVERCLE AVEC VIS 1/4 DE TOUR - PAROIES LISSES

HALOGEN FREE SANS HALOGENES		IP 56		-15°/+60°	TB 120 °C	GWT 850 °C	IK 08	UL94-HB
--	--	-------	--	-----------	--------------	---------------	-------	---------



CODE RÉFÉRENCE	DIMENSIONS DIMENSIONS	SCREW COVER BOUCHONS	PACK Pcs. EMB. Pcs.
OL 20422	150x110x70	∅ 16	45
• OL 20225	300x220x120	∅ 21	6
• OL 20226	380x300x120	∅ 21	4

- hinged lid/couvercle avec charnière

* For a double and complete insulation use plastic screw cover (p. 61)/Double et complète isolation en utilisant les bouchons (p. 61)

J. B. WITH MEMBRANE GLAND AND QUICK FIXING 1/4 TURN
BOÎTES AVEC PASSECABLES COUVERCLE - VIS 1/4 DE TOUR

TECHNOPOLYMER UL94HB		IP 55		-15°/+60°	TB 75 °C	GWT 650 °C	IK 07	CEI EN 60 670-1 CEI EN 60 670-22 Directive LVD 2006/95/CE
-------------------------	--	-------	--	-----------	-------------	---------------	-------	---



CODE RÉFÉRENCE	DIMENSIONS DIMENSIONS	N. ENTRIES N. ENTRÉES	SCREW COVER BOUCHONS	PACK Pcs. EMB. Pcs.
OL 20080	105x105x50	7	∅ 15	72
OL 20112	150x110x70	10	∅ 16	45

* For a double and complete insulation use plastic screw cover (p. 61)/Double et complète isolation en utilisant les bouchons (p. 61)

SMOOTH-SIDED J. B. HINGED OPENING QUICK FIXING 1/4 TURN
BOÎTES COUVERCLE Á CHARNIÈRE PAROIES LISSES VIS 1/4 DE TOUR

TECHNOPOLYMER UL94HB		IP 56		-15°/+60°	TB 75 °C	GWT 650 °C	IK 07	CEI EN 60 670-1 CEI EN 60 670-22 Directive LVD 2006/95/CE
-------------------------	--	-------	--	-----------	-------------	---------------	-------	---

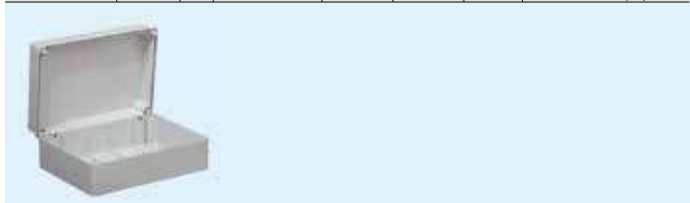

CODE RÉFÉRENCE	DIMENSIONS DIMENSIONS	SCREW COVER BOUCHONS	PACK Pcs. EMB. Pcs.
OL 20025	300x220x120	∅ 21	6
OL 20026	380x300x120	∅ 21	6

* For a double and complete insulation use plastic screw cover (p. 61)/Double et complète isolation en utilisant les bouchons (p. 61)

ELECTRICAL EQUIPMENT INSTALLATION / MATÉRIEL ÉLECTRIQUE D'INSTALLATION

JUNCTION BOXES FOR WALL MOUNTING / BOÎTES DE DÉRIVATION

MEMBRANE GLAND JUNCTION BOX HINGED OPENING
QUICK FIXING 1/4 TURN
BOÎTES COUVERCLE À CHARNIERE AVEC EMBOUTS - VIS 1/4 DE TOUR

TECHNOPOLYMER UL94-HB		IP 55		-15°/+60°	TB 75 °C	GWT 650 °C	IK 07	CEI EN 60 670-1 CEI EN 60 670-22 Directive LVD 2006/95/CE
--------------------------	--	-------	--	-----------	-------------	---------------	-------	---



CODE RÉFÉRENCE	DIMENSIONS DIMENSIONS	N. ENTRIES N. ENTRÉES	SCREW COVER BOUCHONS	PACK Pcs. EMB. Pcs.
OL 20015	300x220x120	12	Ø 21	6
OL 20016	380x300x120	12	Ø 21	6

* For a double and complete insulation use plastic screw cover (p. 61) / Double et complète isolation en utilisant les bouchons (p. 61)

SMOOTH-SIDED JUNCTION BOXES WITH TRASPARENT LID
QUICK FIXING 1/4 TURN
BOÎTES AVEC COUVERCLE TRANSPARENT - PAROIES LISSES - VIS 1/4 DE TOUR

TECHNOPOLYMER UL94-HB		IP 56		-15°/+60°	TB 75 °C	GWT 650 °C	IK 08	CEI EN 60 670-1 CEI EN 60 670-22 Directive LVD 2006/95/CE
--------------------------	--	-------	--	-----------	-------------	---------------	-------	---



CODE RÉFÉRENCE	DIMENSIONS DIMENSIONS	SCREW COVER BOUCHONS	PACK Pcs. EMB. Pcs.
OL 20131	150x110x70	Ø 16	30
• OL 20034	300x220x120	Ø 21	6
• OL 20035*	380x300x120	Ø 21	4

• hinged lid/couvercle avec charnière - * NO IMQ

* For a double and complete insulation use plastic screw cover (p. 61) / Double et complète isolation en utilisant les bouchons (p. 61)

SMOOTH-SIDED JUNCTION BOXES WITH QUICK FIXING 1/4 TURN
BOÎTES COUVERCLE AVEC VIS 1/4 DE TOUR - PAROIES LISSES

TECHNOPOLYMER UL94-V0		IP 56		-15°/+60°	TB 75 °C	GWT 960 °C	IK 07
--------------------------	--	-------	--	-----------	-------------	---------------	-------



CODE RÉFÉRENCE	DIMENSIONS DIMENSIONS	SCREW COVER BOUCHONS	PACK Pcs. EMB. Pcs.
OL 20522	150x110x70	Ø 16	45
• OL 20325	300x220x120	Ø 21	6
• OL 20326	380x300x120	Ø 21	4

• hinged lid/couvercle avec charnière

* For a double and complete insulation use plastic screw cover (p. 61) / Double et complète isolation en utilisant les bouchons (p. 61)

SMOOTH-SIDED JUNCTION BOX - METAL SCREWS
BOÎTES AVEC PAROIES LISSES - VIS METALLIQUES

TECHNOPOLYMER UL94-HB		IP 56		-15°/+60°	TB 75 °C	GWT 650 °C	IK 07	CEI EN 60 670-1 CEI EN 60 670-22 Directive LVD 2006/95/CE
--------------------------	--	-------	--	-----------	-------------	---------------	-------	---



CODE RÉFÉRENCE	DIMENSIONS DIMENSIONS	SCREW COVER BOUCHONS	PACK Pcs. EMB. Pcs.
OL 20021	100x100x50	Ø 14	100
OL 20121	120x80x50	Ø 16	100
OL 20022	150x110x70	Ø 16	45
OL 20023	190x140x70	Ø 21	32
OL 20024	240x190x90	Ø 21	10

* For a double and complete insulation use plastic screw cover (p. 61) / Double et complète isolation en utilisant les bouchons (p. 61)

J. BOXES WITH MEMBRANE GLAND AND METAL SCREW LID
BOÎTES COUVERCLE AVEC VIS METALLIQUES ET PASSECABLES

TECHNOPOLYMER UL94-HB		IP 55		-15°/+60°	TB 75 °C	GWT 650 °C	IK 07	CEI EN 60 670-1 CEI EN 60 670-22 Directive LVD 2006/95/CE
--------------------------	--	-------	--	-----------	-------------	---------------	-------	---



CODE RÉFÉRENCE	DIMENSIONS DIMENSIONS	N. ENTRIES N. ENTRÉES	SCREW COVER BOUCHONS	PACK Pcs. EMB. Pcs.
OL 20011	100x100x50	6	Ø 14	100
OL 20111	120x80x50	6	Ø 16	100
OL 20012	150x110x70	10	Ø 16	45
OL 20013	190x140x70	10	Ø 21	28
OL 20014	240x190x90	12	Ø 21	10

* For a double and complete insulation use plastic screw cover (p. 61) / Double et complète isolation en utilisant les bouchons (p. 61)

SMOOTH-SIDED JUNCTION BOXES WITH METAL SCREW LID
BOÎTES COUVERCLE AVEC VIS METALLIQUES PAROIES LISSES

TECHNOPOLYMER UL94-V0		IP 56		-15°/+60°	TB 75 °C	GWT 960 °C	IK 07
--------------------------	--	-------	--	-----------	-------------	---------------	-------



CODE RÉFÉRENCE	DIMENSIONS DIMENSIONS	SCREW COVER BOUCHONS	PACK Pcs. EMB. Pcs.
OL 20320	100x100x50	Ø 14	100
OL 20321	120x 80x50	Ø 16	100
OL 20322	150x110x70	Ø 16	45
OL 20323	190x140x70	Ø 21	32
OL 20324	240x190x90	Ø 21	10

* For a double and complete insulation use plastic screw cover (p. 61) / Double et complète isolation en utilisant les bouchons (p. 61)

ELECTRICAL EQUIPMENT INSTALLATION / MATÉRIEL ÉLECTRIQUE D'INSTALLATION

JUNCTION BOXES FOR WALL MOUNTING / BOÎTES DE DÉRVATION

SMOOTH-SIDED J. B. WITH TRANSPARENT LID - METAL SCREW
B. AVEC COUVERCLE TRANSPARENT - PAROIES LISSES - VIS METALLIQUES

TECHNOPOLYMER UL94HB		IP 56		-15°/+60°	TB 75 °C	GWT 650 °C	IK 08	CEI EN 60 670-1 CEI EN 60 670-22 Directive B.T. 2006/95/CE
-------------------------	--	-------	--	-----------	-------------	---------------	-------	--



CODE RÉFÉRENCE	DIMENSIONS DIMENSIONS	SCREW COVER BOUCHONS	PACK Pcs. EMB. Pcs.
OL 20031	150x110x70	Ø 16	30
OL 20032	190x140x70	Ø 21	32
OL 20033	240x190x90	Ø 21	10

* For a double and complete insulation use plastic screw cover (p. 61) / Double et complète isolation en utilisant les bouchons (p. 61)

SMOOTH-SIDED JUNCTION BOX WITH METAL SCREW LID
BOÎTES AVEC VIS METALLIQUES PAROIES LISSES

HALOGEN FREE SANS HALOGENES	IP 56		-15°/+60°	TB 120 °C	GWT 850 °C	IK 08
--------------------------------	-------	--	-----------	--------------	---------------	-------

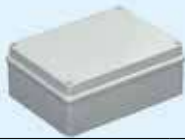

CODE RÉFÉRENCE	DIMENSIONS DIMENSIONS	SCREW COVER BOUCHONS	PACK Pcs. EMB. Pcs.
OL 20220	100x100x50	Ø 14	100
OL 20221	120x 80x50	Ø 16	100
OL 20222	150x110x70	Ø 16	45
OL 20223	190x140x70	Ø 21	32
OL 20224	240x190x90	Ø 21	10

* For a double and complete insulation use plastic screw cover (p. 61) / Double et complète isolation en utilisant les bouchons (p. 61)

SMOOTH-SIDED JUNCTION BOXES WITH GREY HIGH LID AND METAL SCREWS
BOÎTES AVEC COUVERCLE HAUT GRIS - PAROIES LISSES ET VIS METALLIQUES

TECHNOPOLYMER UL94HB		IP 56		-15°/+60°	TB 75 °C	GWT 650 °C	IK 07	CEI EN 60670-1 CEI EN 60670-22 Directive LVD 2006/95/CE
-------------------------	--	-------	--	-----------	-------------	---------------	-------	---



CODE RÉFÉRENCE	DIMENSIONS DIMENSIONS	SCREW COVER BOUCHONS	PACK Pcs. EMB. Pcs.
OL 20041	150x110x140	Ø 16	28
OL 20042	190x140x140	Ø 21	16
OL 20043	240x190x165	Ø 21	8
OL 20044	300x220x180	Ø 21	4

* For a double and complete insulation use plastic screw cover (p. 61) / Double et complète isolation en utilisant les bouchons (p. 61)

SMOOTH-SIDED JUNCTION BOXES WITH HIGH, TRANSPARENT LID AND METAL SCREWS

BOÎTES AVEC COUVERCLE HAUT TRANSPARENT - PAROIES LISSES ET VIS METALLIQUES

TECHNOPOLYMER UL94HB		IP 56		-15°/+60°	TB 75 °C	GWT 650 °C	IK 08
-------------------------	--	-------	--	-----------	-------------	---------------	-------



CODE RÉFÉRENCE	DIMENSIONS DIMENSIONS	SCREW COVER BOUCHONS	PACK Pcs. EMB. Pcs.
OL 20051	150x110x140	Ø 16	28
OL 20052	190x140x140	Ø 21	16
OL 20053	240x190x165	Ø 21	8
OL 20054	300x220x180	Ø 21	4

* For a double and complete insulation use plastic screw cover (p. 61) / Double et complète isolation en utilisant les bouchons (p. 61)

SEALING BUSHINGS
PASSE-CÂBLES

CODE RÉFÉRENCE	Ø MAX	PACK Pcs. EMB. Pcs.
OL 20056	20	1000 (10x100)
OL 20057	25	1000 (10x100)
OL 20058	32	600 (6x100)

ZINC-COATED BACK PLATE FOR SMOOTH-SIDED JUNCTION BOXES
PLATINE CÂBLAGE ZINGUÉE AVEC VIS

CODE RÉFÉRENCE	DIM. J. BOX DIM. BOÎTE	DIM. PLATE DIM. PLATINE	PACK Pcs. EMB. Pcs.
OL 20061	190x140 OL 20013 / 20023 / 20032 20042 / 20052 / 20223	170x130x1,5	30 (30x1)
OL 20062	240x190 OL 20014 / 20024 / 20033 / 20043 / 20053 / 20224	223x178x1,5	25 (25x1)
OL 20063	300x220 OL 20015 / 20025 / 20034 20044 / 20054 / 20225	287x207x1,5	20 (20x1)
OL 20064	380x300 OL 20026 / 20016 20035 / 20226	360x283x1,5	10 (10x1)

ELECTRICAL EQUIPMENT INSTALLATION / MATÉRIEL ÉLECTRIQUE D'INSTALLATION

JUNCTION BOXES FOR WALL MOUNTING / BOÎTES DE DÉRIVATION

WALL FIXING BRACKET WITH SCREWS

PLAQUETTE DE FIXAGE AVEC VIS



CODE RÉFÉRENCE	PACK Pcs. EMB. Pcs.
OL 20090	1000 (10x100)

PLASTIC SCREW FOR BOXES

VIS EN PLASTIQUE POUR BOÎTES

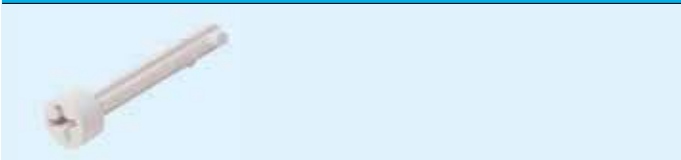

CODE RÉFÉRENCE	FOR ITEM PAR REF.	PACK. Pcs. EMB. Pcs.
OL 20091	OL 20015 / 20016 / 20025 / 20026 / 20034 / 20035 / 20044 / 20054 / 20225 / 20226	1000 (10x100)

PLASTIC SCREW COVER

BOUCHONS COUVRE VIS

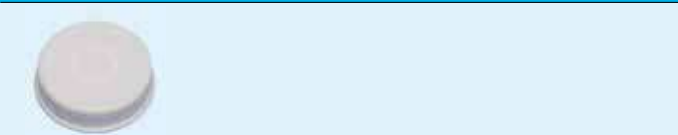

CODE RÉFÉRENCE	Ø	BOXES DIMENSIONS DIMENSIONS BOÎTES	PACK. Pcs. EMB. Pcs.
OL 20096	12	65x35 (Ø) 80x40 (Ø)	100
OL 20097	14	80x80 (OL20003-OL20006) 100x100	100
OL 20098	15	105x105	100
OL 20099	16	80x80 (OL20009) 150x110 / 120x80	100
OL 20100	21	190x140 / 240x190 300x220 / 380x300	100

COMPLETE INSULATION / ISOLATION COMPLÈTE

- Complete insulation of junction boxes according to standard CEI EN 61140 can be obtained by using screw covers OL 20096-20097-20098-20099-20100 or by wall fixing brackets OL 20090.
- L'isolation complète des boîtes selon norme CEI EN 61140 est réalisable par les bouchons couvre-vis OL 20096-20097-20098-20099-20100 ou par plaquette de fixation OL 20090.

NEW
NOUVELLES

**ITEMS SUPPLIED UPON REQUEST
AND FOR QUANTITIES BE AGREED ALSO
IN BLACK, RED, GREEN AND WHITE COLORS.**

ARTICLES FOURNIS SUR DEMANDE
ET POUR DES QUANTITÉS CONVENUES
DANS LES COULEURS NOIR, ROUGE, VERT ET BLANC.



TYPES OF PROTECTION AGAINST INDIRECT CONTACT

Insulating conditions against indirect contacts through insulation system according to CEI EN 61140 standards

TYPES DE PROTECTION CONTRE LES CONTACTS INDIRECTS

Conditions de protection contre les contacts indirects en isolant les normes EN 61 140

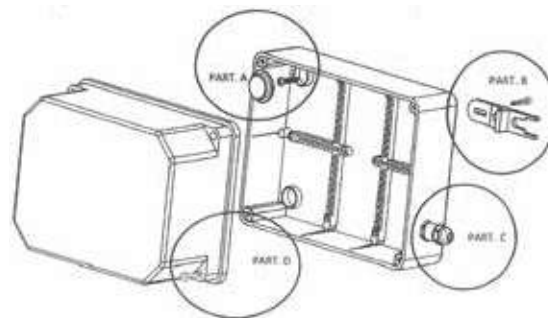

PART. A

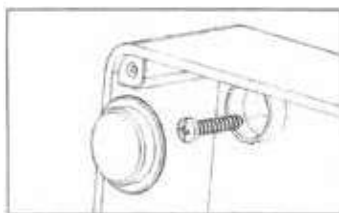

In order to get IP56 it is necessary to use the relevant plastic screw covers:
OL 20096-20097-20098-20099-20100.

Afin d'obtenir la gamme d'isolation IP56, il est nécessaire d'utiliser les bouchons couvre-vis en dotation:
OL20096-20097-20098-20099-20100.

PART. B

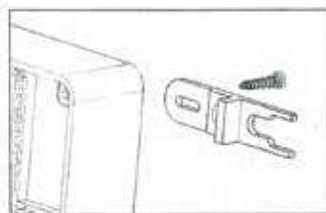

The fastening to the wall of the box bottom is got through suitable brackets OL20090.

La fixation des fonds sur les supports muraux peuvent être obtenus en appliquant consoles en plastique OL20090.

PART. C

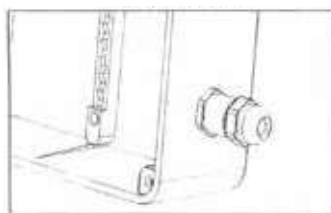

Cable entry by an IP56 pipe-box fitting or IP56 cable gland.

Entrée des cables par un raccord tuyau-boîte IP56 ou un presse-étoupe IP56

PART. D

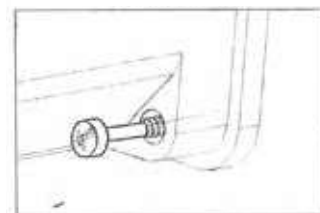

Power to screw the cover screws: 1,2 Nm

Force de torsion pour les vis du couvercle: 1,2 Nm

ELECTRICAL EQUIPMENT INSTALLATION / MATÉRIEL ÉLECTRIQUE D'INSTALLATION

JUNCTION BOXES FOR WALL MOUNTING - TECHNICAL DATA / BOÎTES DE DÉRVATION - CARACTÉRISTIQUES TECHNIQUES

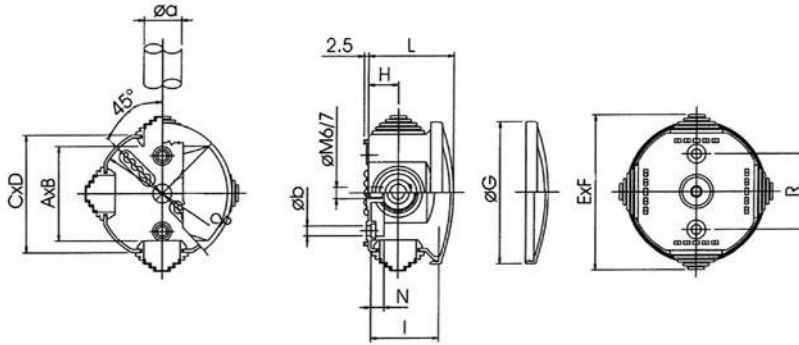

CODE/REF	-A-	-B-	-C-	-D-	-E-	-F-	-G-	-H-	-I-	-L-	-N-	-P-	-R-	-a-	-b-
OL20001	62	62	67	67	80	80	75	16	38	48	7	75	40	20-5	5

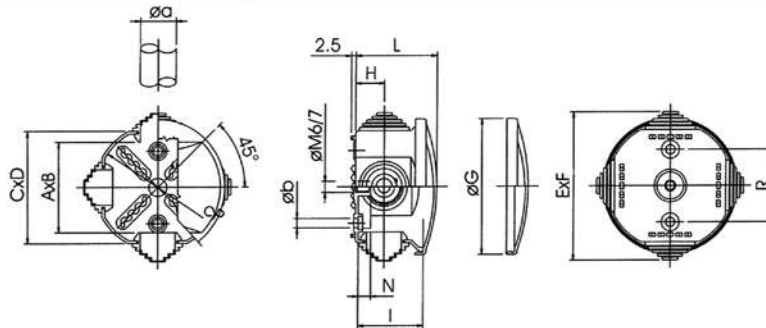

CODE	-A-	-B-	-C-	-D-	-E-	-F-	-G-	-H-	-I-	-L-	-N-	-P-	-R-	-a-	-b-
OL20002	80	80	83	83	100	100	91	16	42	51	7	88	50	20-5	5

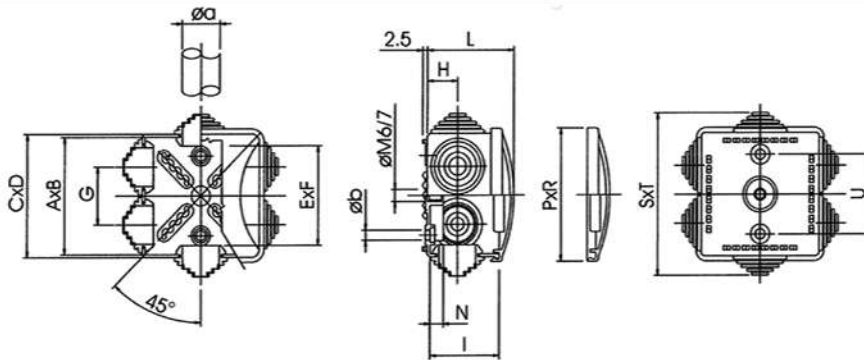

CODE	-A-	-B-	-C-	-D-	-E-	-F-	-G-	-H-	-I-	-L-	-N-	-P-	-R-	-S-	-T-	-U-	-a-	-b-
OL20003	80	80	83	83	71	71	40	16	42	51	7	88	88	103	103	50	20-5	5

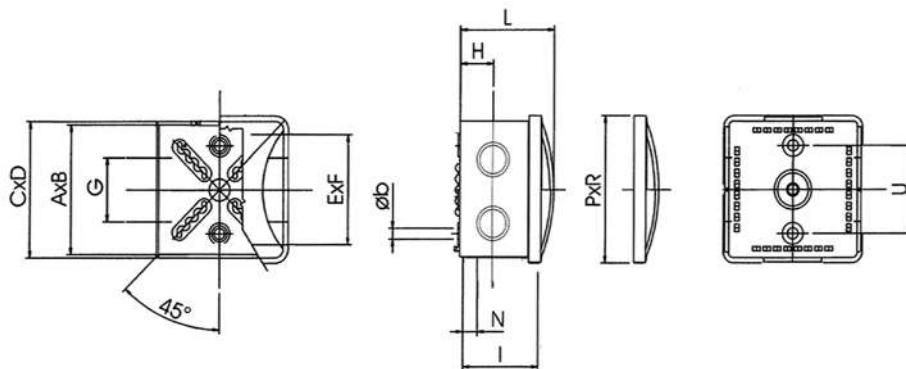

CODE	-A-	-B-	-C-	-D-	-E-	-F-	-G-	-H-	-I-	-L-	-N-	-P-	-R-	-U-	-b-
OL20006	80	80	83	83	63	63	40	16	42	51	7	88	88	50	5

ELECTRICAL EQUIPMENT INSTALLATION / MATÉRIEL ÉLECTRIQUE D'INSTALLATION

JUNCTION BOXES FOR WALL MOUNTING - TECHNICAL DATA / BOÎTES DE DÉRIVATION - CARACTÉRISTIQUES TECHNIQUES

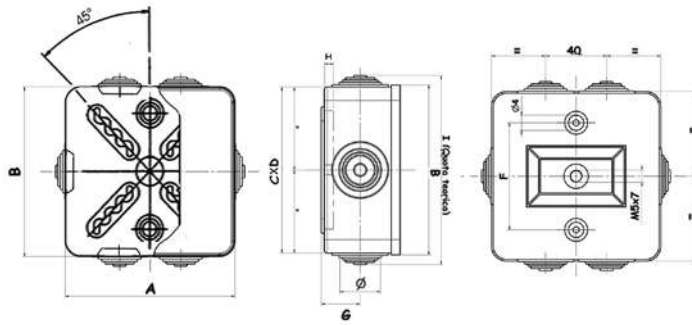

CODE	-A-	-B-	-C-	-D-	-E-	-F-	-G-	-H-	-I-
OL 20009	88	88	83	83	45	50	15	22	7

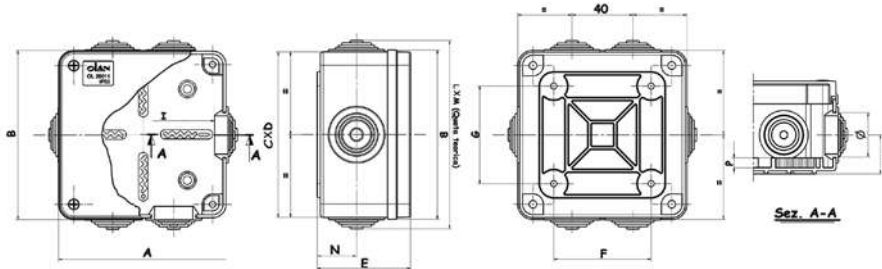

CODE	-A-	-B-	-C-	-D-	-E-	-F-	-G-	-H-	-I-	-L-	-M-	-N-	-O-	-P-
OL20011	108	108	102	102	56	60	60	90	90	120	120	21	28	7

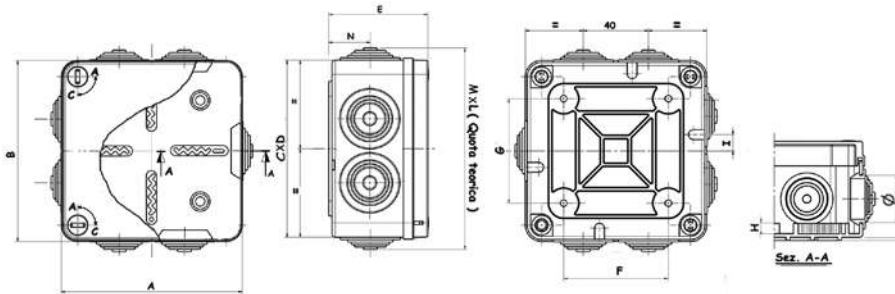

CODE	-A-	-B-	-C-	-D-	-E-	-F-	-G-	-H-	-I-	-L-	-M-	-N-	-O-
OL20080	111	111	108,6	108,6	60,8	64	64	7	10	125	125	25,5	29

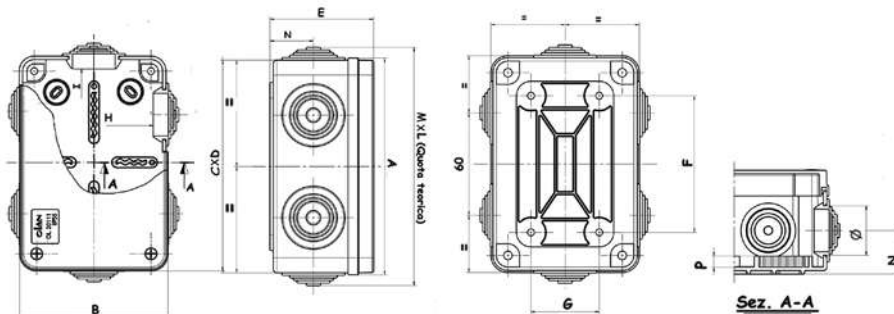

CODE	-A-	-B-	-C-	-D-	-E-	-F-	-G-	-H-	-I-	-L-	-M-	-N-	-O-	-P-
OL20111	128	88	124	84	55	82	42	70	110	138	98	21	28	7

ELECTRICAL EQUIPMENT INSTALLATION / MATÉRIEL ÉLECTRIQUE D'INSTALLATION

JUNCTION BOXES FOR WALL MOUNTING - TECHNICAL DATA / BOÎTES DE DÉRIVATION - CARACTÉRISTIQUES TECHNIQUES

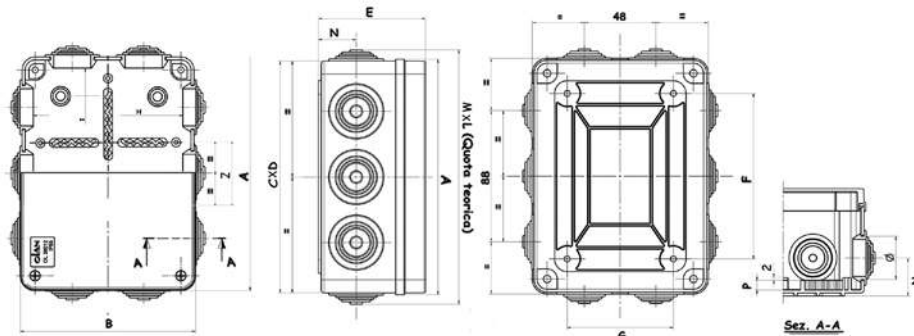

CODE	-A-	-B-	-C-	-D-	-E-	-F-	-G-	-H-	-I-	-L-	-M-	-N-	-O-	-P-	-Z-
OL20012	158	118	154	114	76	112	72	100	140	170	130	21	28	7	45
OL20013	198	148	194	144	76	102	152	126	176	216	166	27	28	7	55

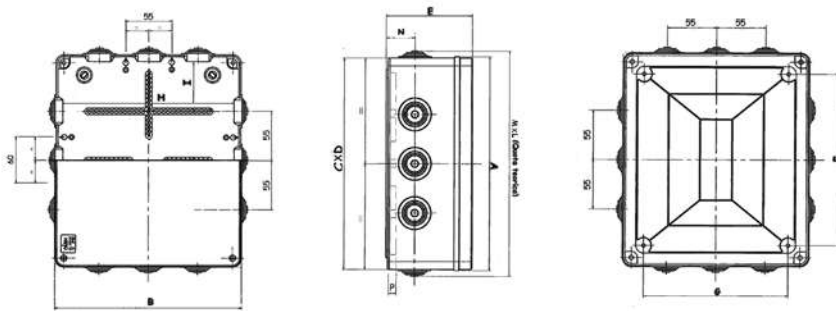

CODE	-A-	-B-	-C-	-D-	-E-	-F-	-G-	-H-	-I-	-L-	-M-	-N-	-O-	-P-
OL20014	248	198	244	194	95	200	150	180	230	266	216	27	28	7

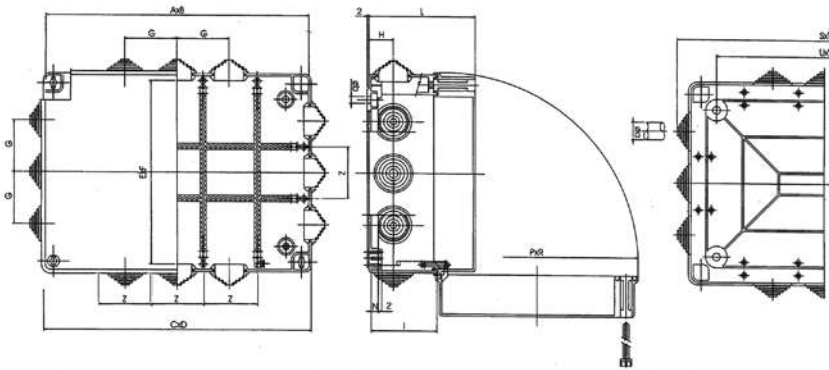

CODE	-A-	-B-	-C-	-D-	-E-	-F-	-G-	-H-	-I-	-L-	-N-	-P-	-R-	-S-	-T-	-U-	-V-	-Z-	-a-	-b-
OL20015	305	230	310	235	215	295	60	28	78	125	7	235	315	335	225	250	170	62	32.5	8

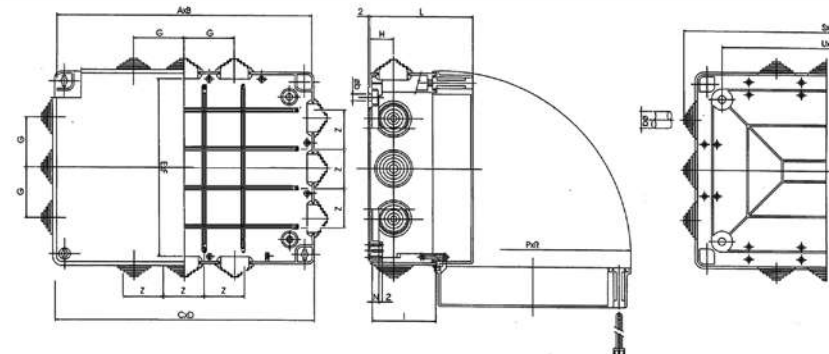

CODE	-A-	-B-	-C-	-D-	-E-	-F-	-G-	-H-	-I-	-L-	-N-	-P-	-R-	-S-	-T-	-U-	-V-	-Z-	-a-	-b-
OL20016	400	315	380	300	295	375	62	35	80	128	7	315	395	415	325	330	250	62	32.5	8

ELECTRICAL EQUIPMENT INSTALLATION / MATÉRIEL ÉLECTRIQUE D'INSTALLATION

JUNCTION BOXES FOR WALL MOUNTING - TECHNICAL DATA / BOÎTES DE DÉRIVATION - CARACTÉRISTIQUES TECHNIQUES

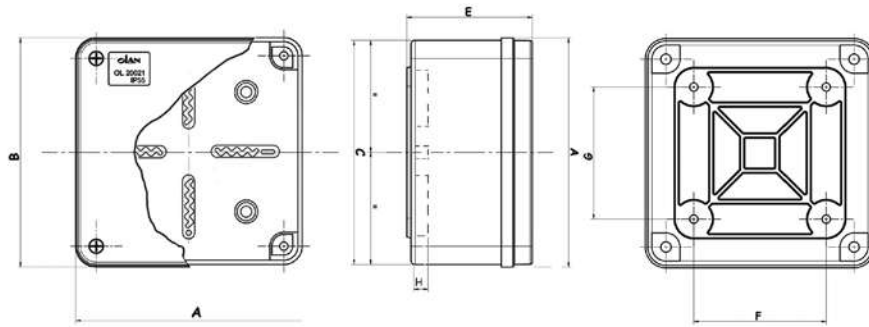

CODE	-A-	-B-	-C-	-D-	-E-	-F-	-G-	-H-	-I-	-L-	-M-	-N-	-O-	-P-
OL20021	108	108	102	102	56	60	60	7	-	-	-	-	-	-

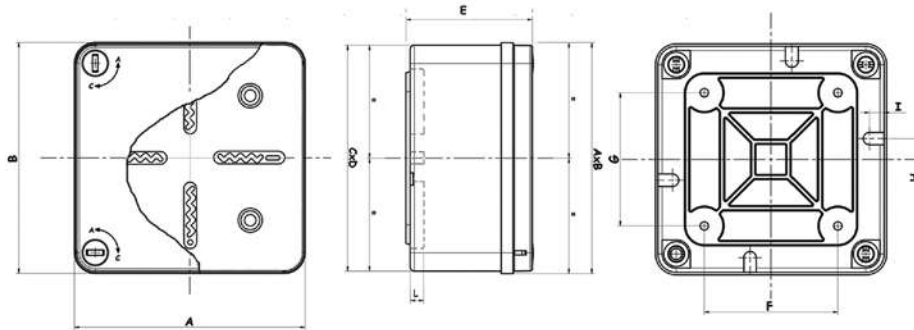

CODE	-A-	-B-	-C-	-D-	-E-	-F-	-G-	-H-	-I-	-L-	-M-	-N-	-O-	-P-
OL20070	111	111	108,6	108,6	60,8	64	64	10	7	7	-	-	-	-

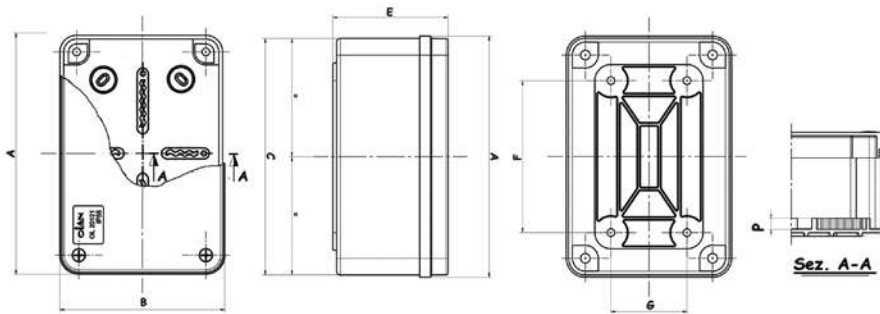

CODE	-A-	-B-	-C-	-D-	-E-	-F-	-G-	-H-	-I-	-L-	-M-	-N-	-O-	-P-
OL20121	128	88	124	84	55	82	42	-	-	-	-	-	-	7

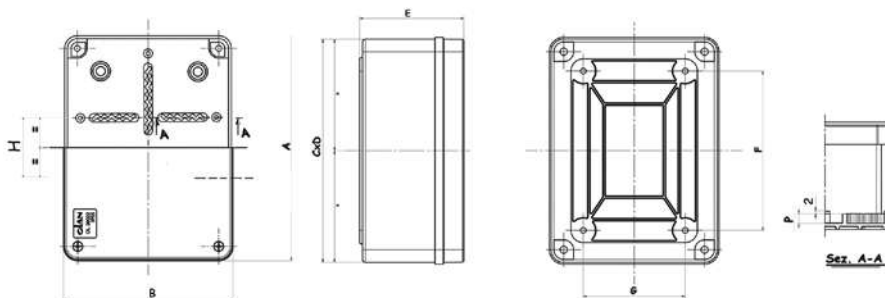

CODE	-A-	-B-	-C-	-D-	-E-	-F-	-G-	-H-	-I-	-L-	-M-	-N-	-P-
OL20022	158	118	154	114	76	112	72	45	-	-	-	-	7
OL20023	198	148	194	144	76	144	98	55	-	-	-	-	7

ELECTRICAL EQUIPMENT INSTALLATION / MATÉRIEL ÉLECTRIQUE D'INSTALLATION

JUNCTION BOXES FOR WALL MOUNTING - TECHNICAL DATA / BOÎTES DE DÉRIVATION - CARACTÉRISTIQUES TECHNIQUES

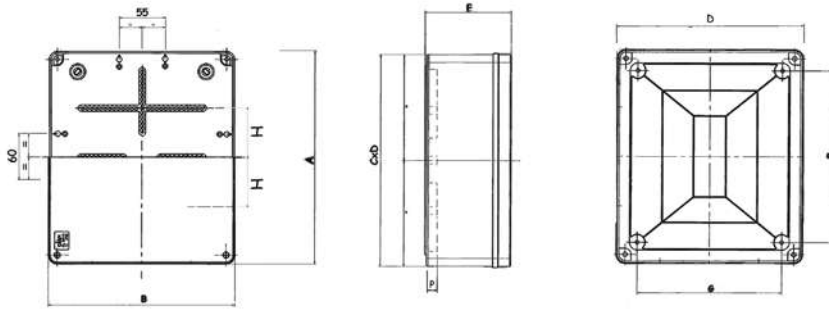

CODE	-A-	-B-	-C-	-D-	-E-	-F-	-G-	-H-	-I-	-L-	-M-	-N-	-P-
OL20024	248	198	244	194	95	200	150	55	-	-	-	-	7

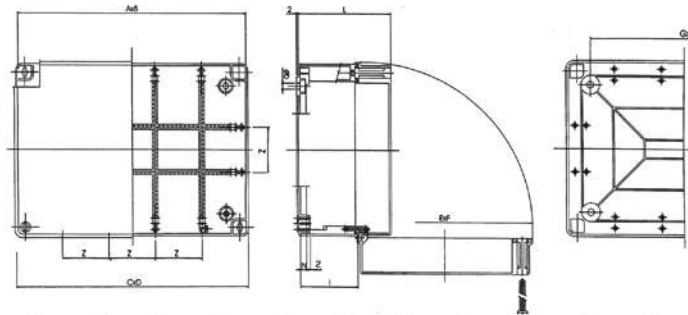

CODE	-A-	-B-	-C-	-D-	-E-	-F-	-G-	-H-	-I-	-L-	-N-	-b-	-Z-
OL20025	305	230	310	235	235	315	250	170	78	125	7	8	62

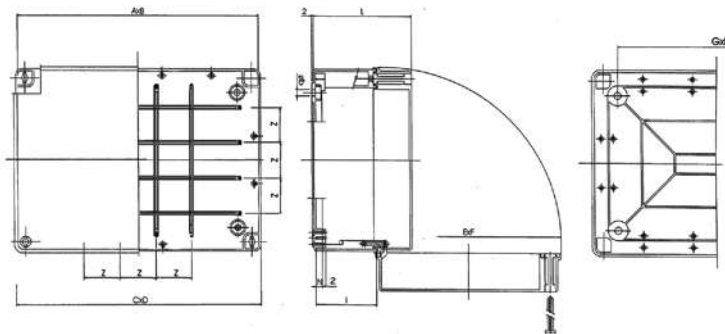

CODE	-A-	-B-	-C-	-D-	-E-	-F-	-G-	-H-	-I-	-L-	-N-	-b-	-Z-
OL20026	400	315	380	300	295	375	330	250	80	128	7	8	62

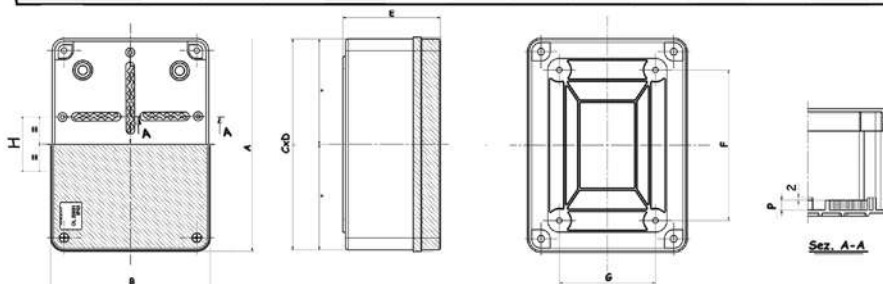

CODE	-A-	-B-	-C-	-D-	-E-	-F-	-G-	-H-	-I-	-L-	-M-	-N-	-O-	-P-
OL20031	158	118	154	114	76	112	72	45	-	-	-	-	-	7
OL20032	198	148	194	144	76	142	102	55	-	-	-	-	-	7

ELECTRICAL EQUIPMENT INSTALLATION / MATÉRIEL ÉLECTRIQUE D'INSTALLATION

JUNCTION BOXES FOR WALL MOUNTING - TECHNICAL DATA / BOÎTES DE DÉRIVATION - CARACTÉRISTIQUES TECHNIQUES

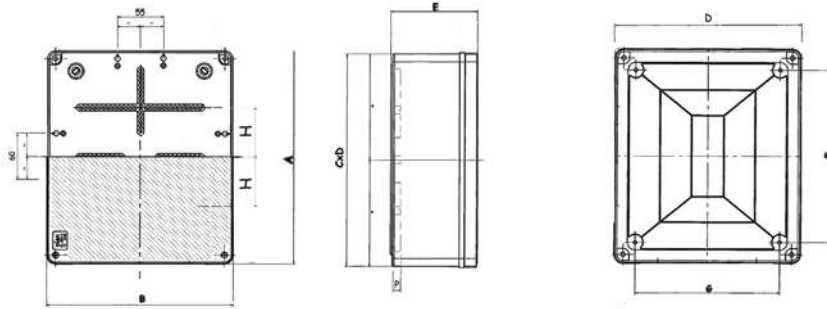

CODE	-A-	-B-	-C-	-D-	-E-	-F-	-G-	-H-	-I-	-L-	-M-	-N-	-O-	-P-
OL20033	248	198	244	194	95	200	150	55	-	-	-	-	-	7

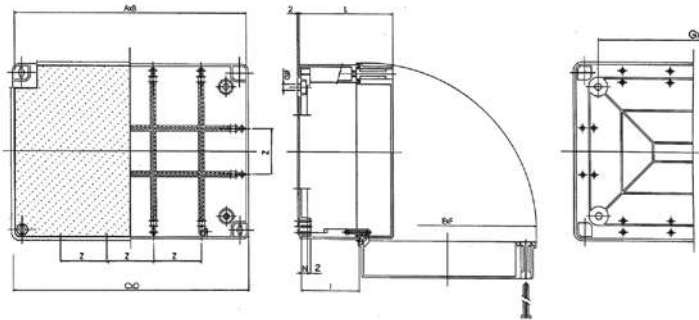

CODE	-A-	-B-	-C-	-D-	-E-	-F-	-G-	-H-	-I-	-L-	-N-	-b-	-Z-
OL20034	305	230	310	235	235	315	250	170	78	125	7	8	62

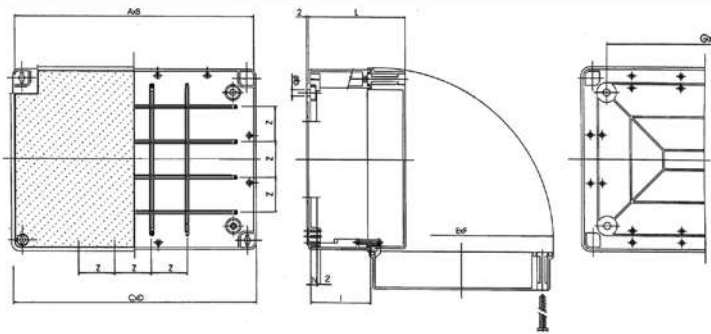

CODE	-A-	-B-	-C-	-D-	-E-	-F-	-G-	-H-	-I-	-L-	-N-	-b-	-Z-
OL20035	400	315	380	300	295	375	330	250	80	128	7	8	62

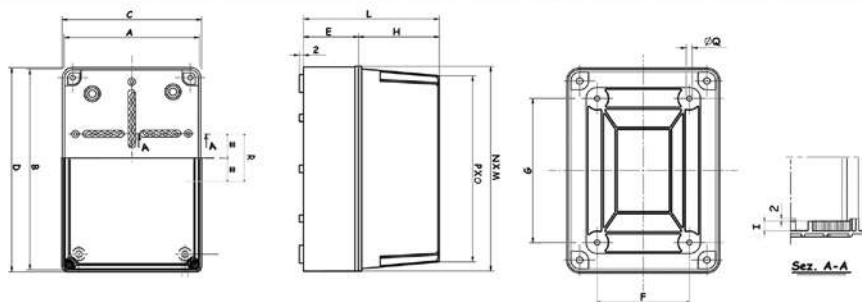

CODE	-A-	-B-	-C-	-D-	-E-	-F-	-G-	-H-	-I-	-L-	-M-	-N-	-O-	-P-	-Q-	-R-
OL20041	118	158	114	154	52	72	112	90	7	140	120	160	100	140	8	45
OL20042	148	198	144	194	55	110	150	90	7	140	150	200	130	180	8	55

ELECTRICAL EQUIPMENT INSTALLATION / MATÉRIEL ÉLECTRIQUE D'INSTALLATION

JUNCTION BOXES FOR WALL MOUNTING - TECHNICAL DATA / BOÎTES DE DÉRIVATION - CARACTÉRISTIQUES TECHNIQUES

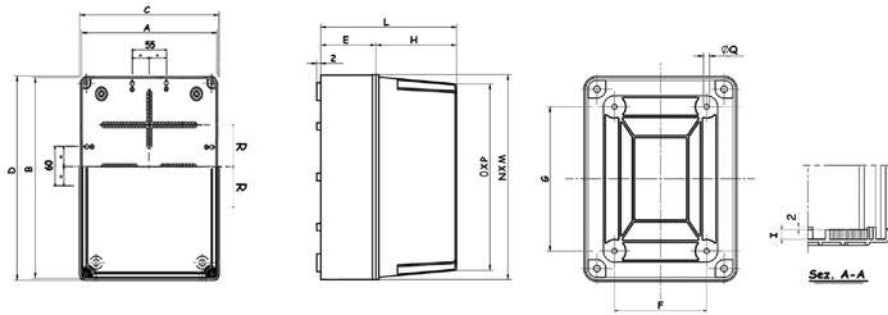

CODE	-A-	-B-	-C-	-D-	-E-	-F-	-G-	-H-	-I-	-L-	-M-	-N-	-O-	-P-	-Q-	-R-
OL20043	198	248	194	244	52	150	200	95	7	165	194	244	180	230	8	55

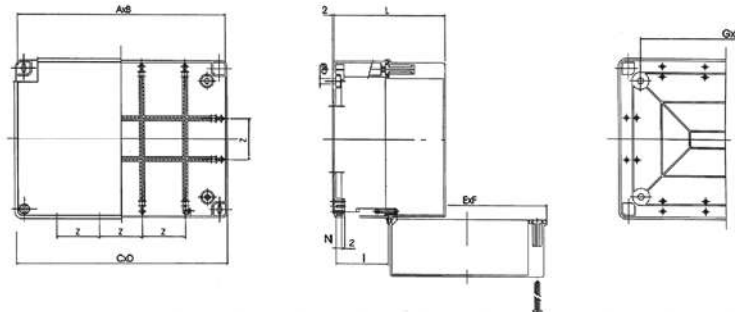

CODE	-A-	-B-	-C-	-D-	-E-	-F-	-G-	-H-	-I-	-L-	-N-	-b-	-Z-
OL20044	305	230	310	230	235	315	250	170	78	180	7	8	62

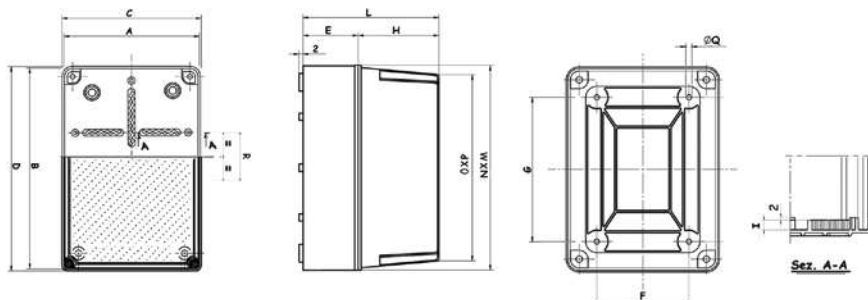

CODE	-A-	-B-	-C-	-D-	-E-	-F-	-G-	-H-	-I-	-L-	-M-	-N-	-O-	-P-	-Q-	-R-
OL20051	118	158	114	154	52	72	112	90	7	140	120	160	100	140	8	45
OL20052	148	198	144	194	55	110	150	90	8	140	150	200	130	180	8	55

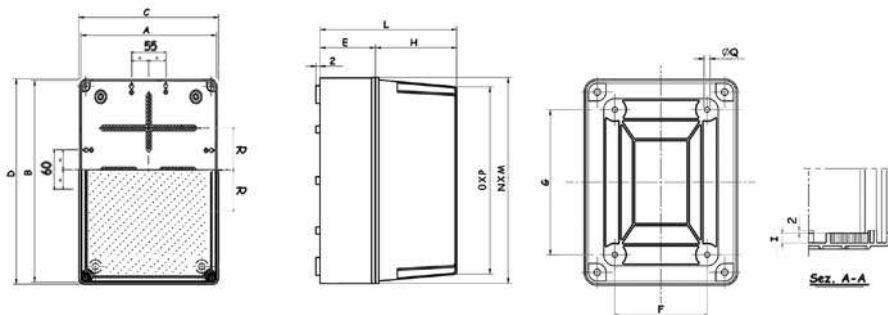

CODE	-A-	-B-	-C-	-D-	-E-	-F-	-G-	-H-	-I-	-L-	-M-	-N-	-O-	-P-	-Q-	-R-
OL20053	198	248	194	244	52	150	200	95	7	165	194	244	180	230	8	55

ELECTRICAL EQUIPMENT INSTALLATION / MATÉRIEL ÉLECTRIQUE D'INSTALLATION

JUNCTION BOXES FOR WALL MOUNTING - TECHNICAL DATA / BOÎTES DE DÉRVATION - CARACTÉRISTIQUES TECHNIQUES

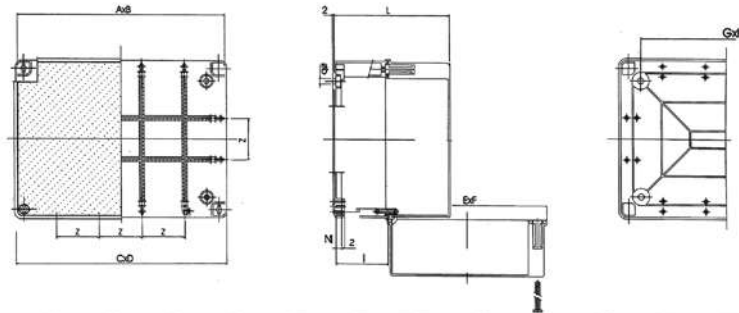

CODE	-A-	-B-	-C-	-D-	-E-	-F-	-G-	-H-	-I-	-L-	-N-	-b-	-Z-
OL20054	305	230	310	235	235	315	250	170	78	180	7	8	62

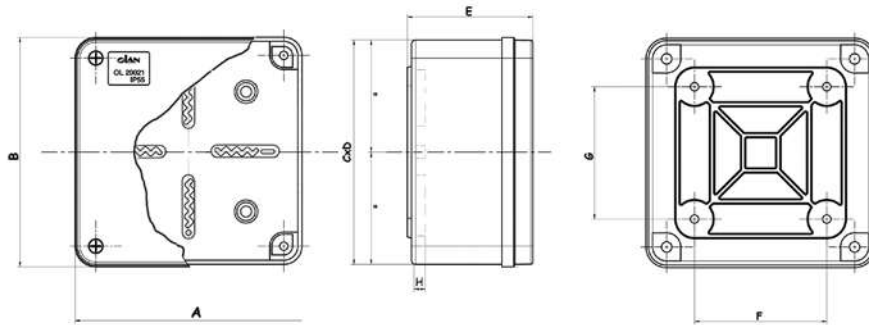

OL20320

CODE	-A-	-B-	-C-	-D-	-E-	-F-	-G-	-H-	-I-	-L-	-M-	-N-	-O-	-P-
OL20220	108	108	102	102	56	60	60	7	-	-	-	-	-	7

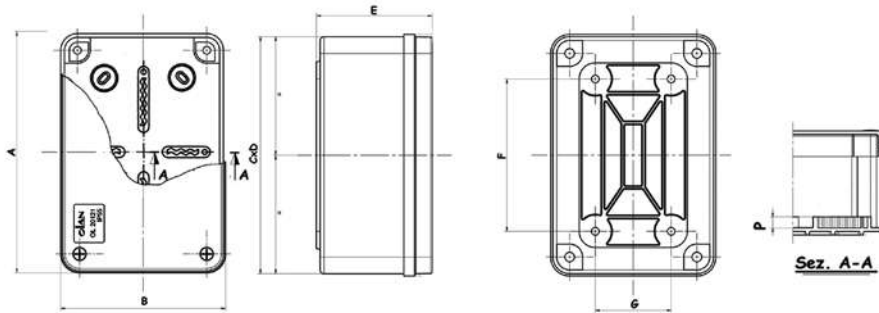

OL20321

CODE	-A-	-B-	-C-	-D-	-E-	-F-	-G-	-H-	-I-	-L-	-M-	-N-	-O-	-P-
OL20221	128	88	124	84	55	82	42	-	-	-	-	-	-	7

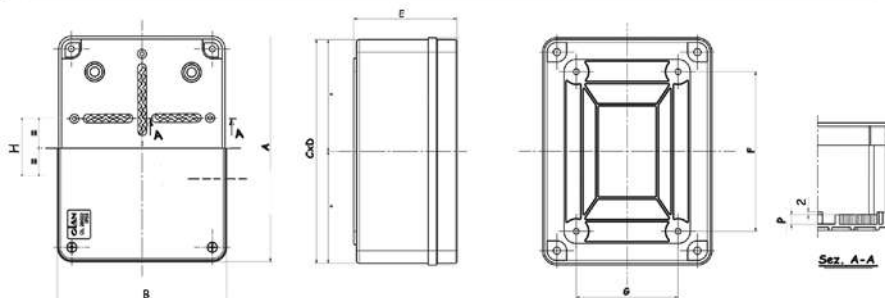

OL20322

OL20323

CODE	-A-	-B-	-C-	-D-	-E-	-F-	-G-	-H-	-I-	-L-	-M-	-N-	-O-	-P-
OL20222	158	118	154	114	76	112	72	45	-	-	-	-	-	7
OL20223	198	148	194	144	76	102	142	55	-	-	-	-	-	7

ELECTRICAL EQUIPMENT INSTALLATION / MATÉRIEL ÉLECTRIQUE D'INSTALLATION

JUNCTION BOXES FOR WALL MOUNTING - TECHNICAL DATA / BOÎTES DE DÉRIVATION - CARACTÉRISTIQUES TECHNIQUES

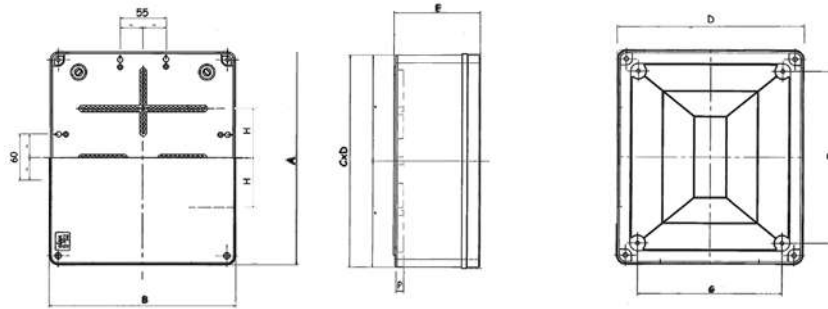

CODE	-A-	-B-	-C-	-D-	-E-	-F-	-G-	-H-	-I-	-L-	-M-	-N-	-O-	-P-
OL20324	OL20224	248	198	244	194	95	200	150	55	-	-	-	-	7

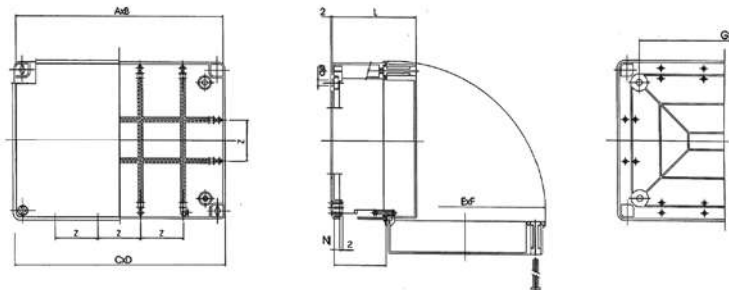

CODE	-A-	-B-	-C-	-D-	-E-	-F-	-G-	-H-	-I-	-L-	-N-	-b-	
OL20325	OL 20225	305	230	310	235	235	315	250	170	78	125	7	8

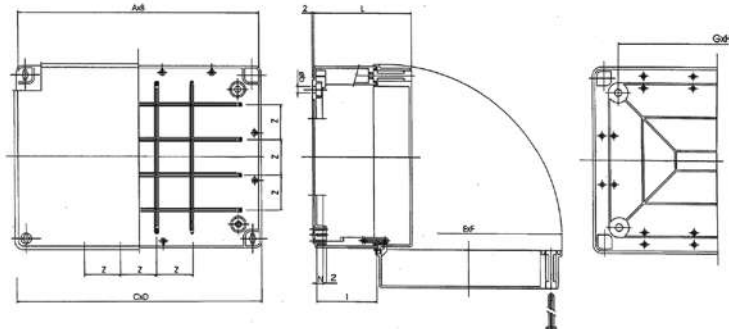

CODE	-A-	-B-	-C-	-D-	-E-	-F-	-G-	-H-	-I-	-L-	-N-	-b-	-Z-	
OL20326	OL 20226	400	315	380	300	295	375	330	250	80	128	7	8	62

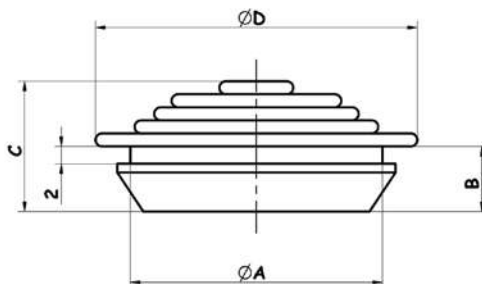

CODE	-A-	-B-	-C-	-D-
OL 20056	22	7,5	15	35
OL 20057	27	7,5	15	37
OL 20058	34	7,5	15	40

ELECTRICAL EQUIPMENT INSTALLATION / MATÉRIEL ÉLECTRIQUE D'INSTALLATION

JUNCTION BOXES FOR WALL MOUNTING - TECHNICAL DATA / BOÎTES DE DÉRIVATION - CARACTÉRISTIQUES TECHNIQUES

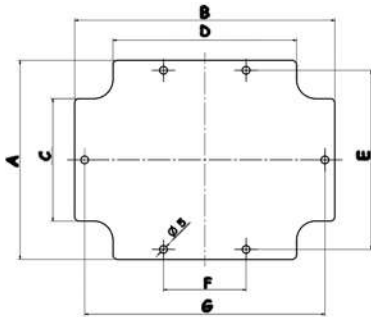

VALID FOR THE FOLLOWING J. BOXES
VALABLE POUR LES PRODUITS SUIVANTS

OL 20013-OL20032
OL 20042-OL 20052- OL 20223

CODE	THICKNESS ÉPAISSEUR	-A-	-B-	-C-	-D-	-E-	-F-	-G-	-H-	-I-
OL20061	1,5 mm	130	170	80	120	117	55	157	-	-

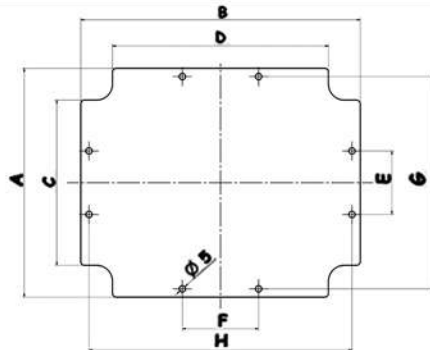

VALID FOR THE FOLLOWING J. BOXES
VALABLE POUR LES PRODUITS SUIVANTS

OL 20014-OL 20024-OL 20033
OL 20043-OL 20053- OL 20224

CODE	THICKNESS ÉPAISSEUR	-A-	-B-	-C-	-D-	-E-	-F-	-G-	-H-	-I-
OL20062	1,5 mm	178	222	122	166	55	60	160	210	-

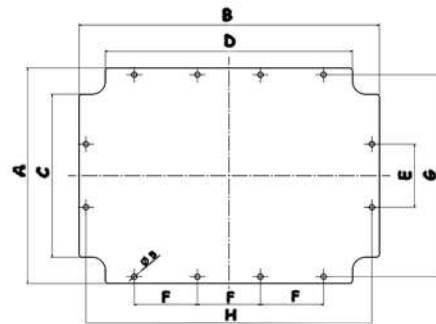

VALID FOR THE FOLLOWING J. BOXES
VALABLE POUR LES PRODUITS SUIVANTS

OL 20015-OL 20025-OL 20034
OL 20044-OL 20054-OL 20225

CODE	THICKNESS ÉPAISSEUR	-A-	-B-	-C-	-D-	-E-	-F-	-G-	-H-	-I-
OL20063	1,5 mm	207	287	150	230	62	62	195	275	-

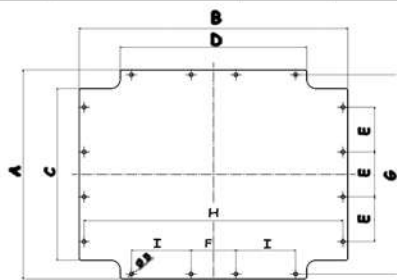

VALID FOR THE FOLLOWING J. BOXES
VALABLE POUR LES PRODUITS SUIVANTS

OL 20016-OL 20026
OL 20035-OL 20226

CODE	THICKNESS ÉPAISSEUR	-A-	-B-	-C-	-D-	-E-	-F-	-G-	-H-	-I-
OL20064	1,5 mm	282	362	230	250	62	62	262	345	80

ELECTRICAL EQUIPMENT INSTALLATION / MATÉRIEL ÉLECTRIQUE D'INSTALLATION

FLUSH AND WALL DISTRIBUTION BOARDS / COFFRETS DE DISTRIBUTION

FLUSH DISTRIBUTION BOARDS

COFFRETS DE DISTRIBUTION À ENCASTRER

IP 40			-25°/+60°	TB 70 °C	GWT 650 °C	IK 07	EN 60670-1 EN 60670-24 DIRECTIVE: LVD 2006/95/CE
-------	---	---	-----------	-------------	---------------	-------	--



CODE RÉFÉRENCE	DIMENSIONS DIMENSIONS	N. MODULES N. MODULES	DISSIPATE PWR (W) PWR DISSIPÉE (W)	MOD./ROW FICHER MOD.	PACK Pcs. EMB. Pcs.
OL 40211	120x200x95	2/4	16		12
OL 40212	175x200x95	4/7	16		24
OL 40213	230x200x95	6/10	20		20
OL 40214	300x200x95	10/14	24		16
OL 40215	315x415x105	12/26	44		1
OL 40216	315x525x105	18/39	49		1

DISTRIBUTION BOARDS WITHOUT DOOR, PLASTIC RAIL

COFFRETS SAILLIES SANS PORTE RAIL DIN SYMÉTRIQUE MOULÉ DANS LA BASE

IP 20			-5°/+60°	TB 70 °C	GWT 650 °C	IK 07	EN 60670-24
-------	---	---	----------	-------------	---------------	-------	-------------



CODE RÉFÉRENCE	DIMENSIONS DIMENSIONS	N. MODULES N. MODULES	DISSIPATE PWR (W) PWR DISSIPÉE (W)	MOD./ROW FICHER MOD.	PACK Pcs. EMB. Pcs.
OL 40005	130x45x85	1/2	8	1	60
OL 40006	130x90x85	2/4	12	1	30

PROTECTED DISTRIB. BOARDS WITHOUT DOOR METAL DIN RAIL

COFFRETS SAILLIE SANS PORTE RAIL DIN SYMÉTRIQUE

IP 40			-5°/+60°	TB 70 °C	GWT 650 °C	IK 07	EN 60670-24
-------	---	---	----------	-------------	---------------	-------	-------------



CODE RÉFÉRENCE	DIMENSIONS DIMENSIONS	N. MOD. N. MOD.	DISSIPATE PWR (W) PWR DISSIPÉE (W)	MOD./ROW FICHER MOD.	PACK Pcs. EMB. Pcs.
OL 40011	150x160x107	4	15	1	10
OL 40012	200x180x100	8	20	1	8
OL 40013	280x220x100	12	30	1	3
OL 40014	280x300x100	24	37	2	1
OL 40015	380x380x130	36	80	2	1

* Number of media slots connectors/Nombre de logements médias connecteurs

Plastic covers for complete electrical insulation included/Bouchons couvre-vis pour l'isolation électrique complète inclus

METAL DIN RAIL TO SIZE FOR WATER-TIGHT DISTRIBUTION BOARDS
KIT DIN SYMÉTRIQUE OMEGA

CODE RÉFÉRENCE	FOR D. BOARDS POUR C. SAILLIES	DIM. DIM.	N. MOD. N. MOD.	BOX Pcs. COLIS PCS.	PACK Pcs. EMB. Pcs.
OL 40051	IP 65	100	4	20	100
OL 40052	IP 65	180	8	20	100
OL 40053	IP 65	250	12	20	100

PROTECTED DISTRIBUTION BOARDS WITH DOOR, METAL DIN RAIL

COFFRETS SAILLIE AVEC PORTE-FUMÉE RAIL DIN SYMÉTRIQUE

IP 40			-5°/+60°	TB 70 °C	GWT 650 °C	IK 07	
-------	---	---	----------	-------------	---------------	-------	--



CODE RÉFÉRENCE	DIMENSIONS DIMENSIONS	N. MOD. N. MOD.	DISSIPATE PWR (W) PWR DISSIPÉE (W)	MOD./ROW FICHER MOD.	PACK Pcs. EMB. Pcs.
OL 40021	150x160x107	4	10	1	10
OL 40022	200x180x100	8	14	1	8
OL 40023	280x220x100	12	17	1	3
OL 40024	280x300x100	24	18	2	1
OL 40025	380x380x130	36	37	2	1

* Number of media slots connectors/Nombre de logements médias connecteurs

Plastic covers for complete electrical insulation included/Bouchons couvre-vis pour l'isolation électrique complète inclus

WATER-TIGHT DISTRIBUTION BOARDS WITH DARK DOOR AND METAL DIN RAIL

COFFRETS SAILLIES ETANCHE AVEC PORTE FUMÉE RAIL DIN SYMÉTRIQUE

	IP 65			-25°/+60°	TB 70 °C	GWT 650 °C	IK 08	EN 60670-24 DIRECTIVE LVD 2006/95/CE
---	-------	---	--	-----------	-------------	---------------	-------	---



CODE RÉFÉRENCE	DIMENSIONS DIMENSIONS	N. MOD. N. MOD.	DISSIPATE PWR (W) PWR DISSIPÉE (W)	MOD./ROW FICHER MOD.	PACK Pcs. EMB. Pcs.
OL 40031	120x160x90	4	8	1	24
OL 40032	200x160x90	8	11	1	20
OL 40033	250x200x110	12	17	1	12
OL 40034*	250x375x145	24	30	2	1
OL 40035*	350x500x140	48	45	3	1

* Number of media slots connectors/Nombre de logements médias connecteurs

*Plastic covers for complete electrical insulation included/Bouchons couvre-vis pour l'isolation électrique complète inclus

WALL-MOUNTING CASES FOR DIN RAIL
BOÎTIER POUR DIN SYMÉTRIQUE

IP 20



CODE RÉFÉRENCE	DESCRIPTION DESCRIPTION	BOX Pcs. COLIS PCS.
OL 40061	One-gang holder for 1,5 modules Porte-mécanisme individuel pour 1,5 modules DIN	24
OL 40062	Schuko socket 2P 16A+T3M Din Prise schuko 2P 16A+T3M Din	15

ELECTRICAL EQUIPMENT INSTALLATION / MATÉRIEL ÉLECTRIQUE D'INSTALLATION

FLUSH AND WALL DISTRIBUTION BOARDS - TECHNICAL DATA / COFFRETS DE DISTRIBUTION - CARACTÉRISTIQUES TECHNIQUES

SUPPORT + CONNECTORS KIT
BARRETTES DE CONNEXION EN LAITON

CODE RÉFÉRENCE	FOR D. BOARDS POUR C. SAILLIES	DESCRIPTION DESCRIPTION	BOX Pcs. COLIS PCS.	PACK Pcs. EMB. Pcs.
OL 49482	OL 40011 OL 40021 OL 40031	1 support, 2 connectors 5p-10mm ²	1	20
OL 49584	OL 40012 OL 40022	1 support, 2 connectors 2p-16mm ² +8p-10mm ²	1	20
OL 49685	OL 40013 OL 40023	1 support, 2 connectors 2p-16mm ² +12p-10mm ²	1	20
OL 496851	OL 40014 OL 40015 OL 40024 OL 40025	2 supports, 2 connectors 2p-16mm ² +12p-10mm ²	1	20
OL 49284	OL 40032	1 support, 2 connectors 2p-16mm ² +8p-10mm ²	1	20
OL 49385	OL 40033	1 support, 2 connectors 2p-16mm ² +12p-10mm ²	1	20
OL 493851	OL 40034 OL 40035	2 supports, 4 connectors 2p-16mm ² +12p-10mm ²	1	20

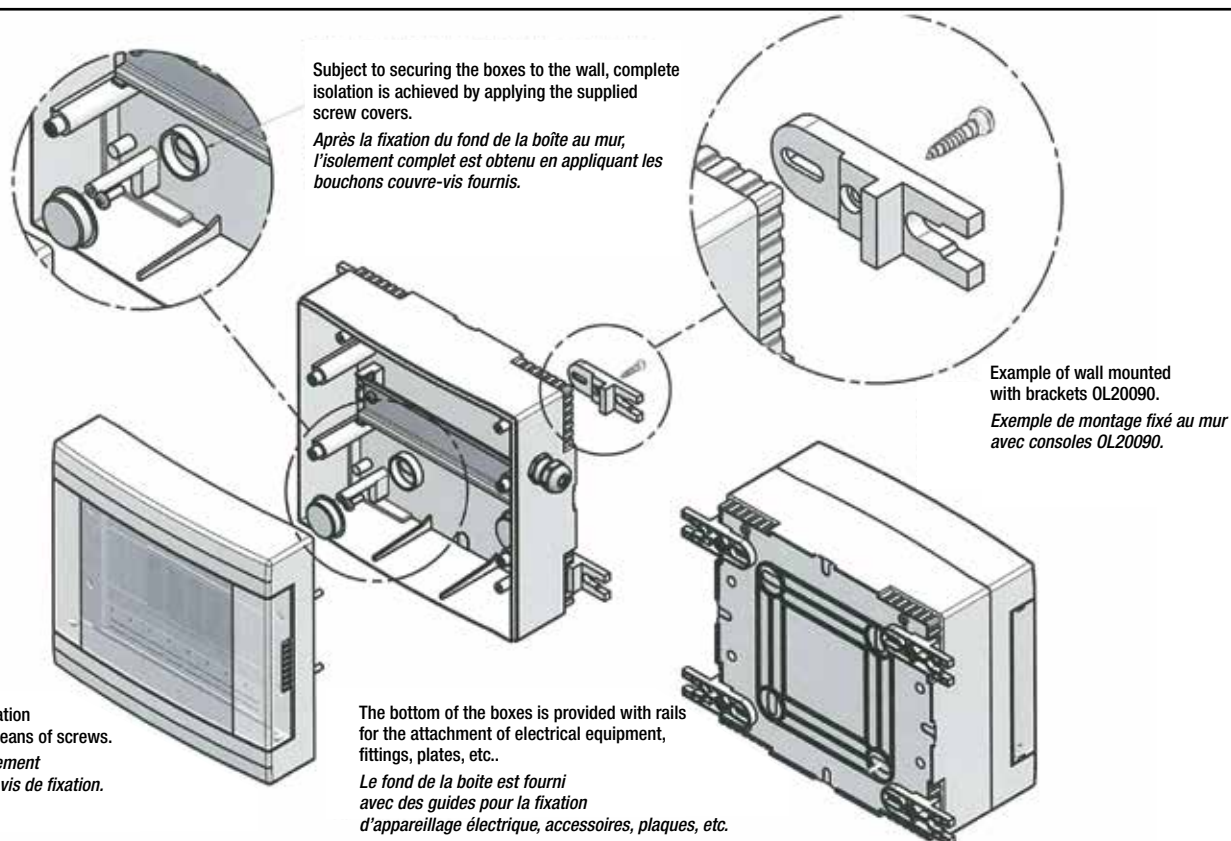

ELECTRICAL EQUIPMENT INSTALLATION / MATÉRIEL ÉLECTRIQUE D'INSTALLATION

FLUSH AND WALL DISTRIBUTION BOARDS - TECHNICAL DATA / COFFRETS DE DISTRIBUTION - CARACTÉRISTIQUES TECHNIQUES

Knockout holes for input and output.
Trous pour entrée et sortie.

Possibility of housing terminal T + N
connectors on both ends.
*Possibilité de logement terminal T + N
sur les deux extrémités.*

Prepared for Base + Door sealing.
Préparation de base + joint de la porte.

Possibility of fastening the enclosures
on the outside.
Possibilité de fixer les tableaux à l'extérieur.

Insulated plastic screws.
Vis isolées en plastique.

Prepared for fixing the
DIN rail at three levels of
height.
*Préparation pour la fixation
à trois niveaux de hauteur
du rail DIN.*

Insulating covers.
Capuchons isolants.

Prepared for fixing door with security screw.
*Préparation pour la fixation de la porte
avec la vis de sécurité.*

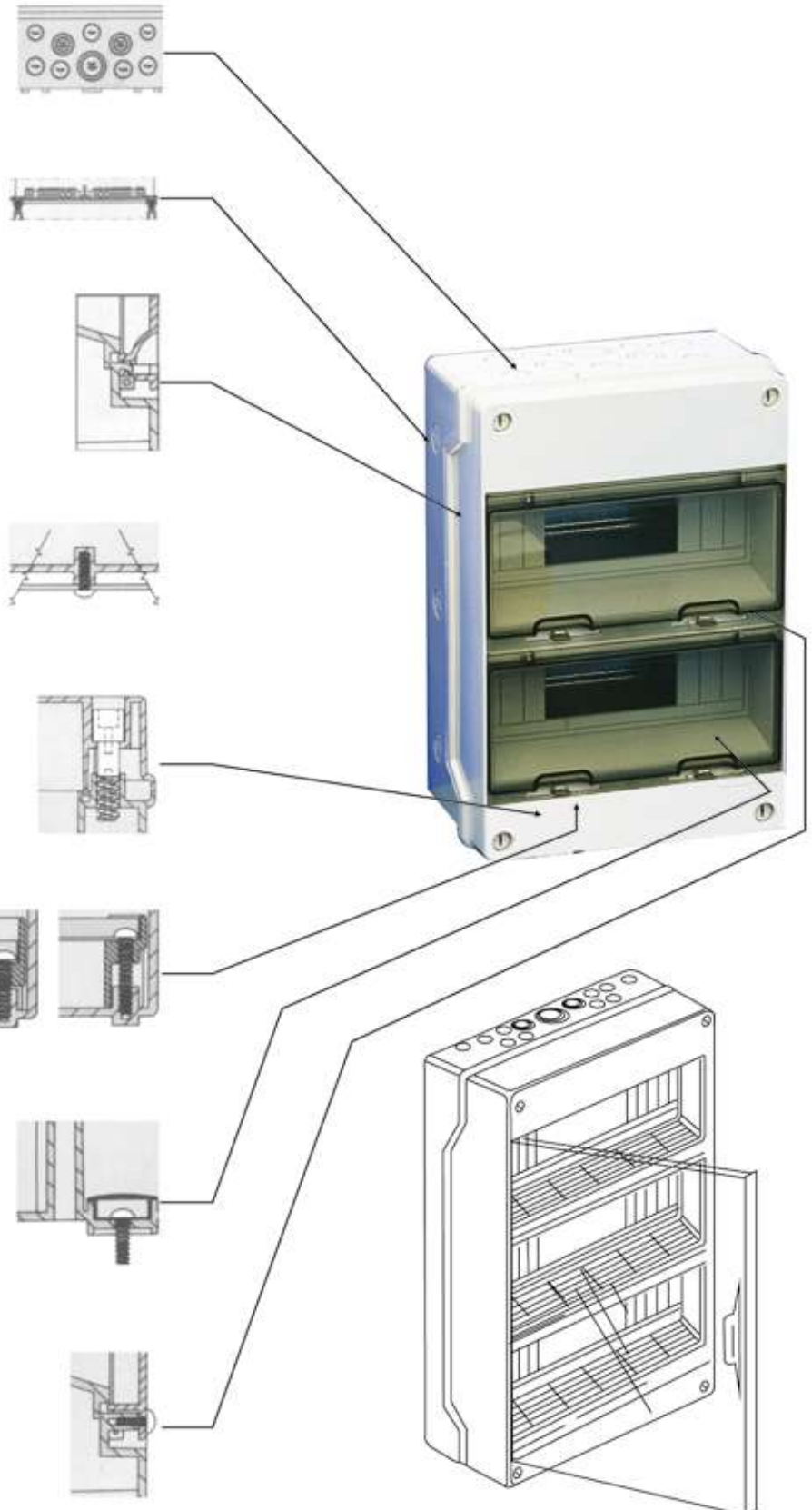

ELECTRICAL EQUIPMENT INSTALLATION / MATÉRIEL ÉLECTRIQUE D'INSTALLATION

FLUSH AND WALL DISTRIBUTION BOARDS - TECHNICAL DATA / COFFRETS DE DISTRIBUTION - CARACTÉRISTIQUES TECHNIQUES

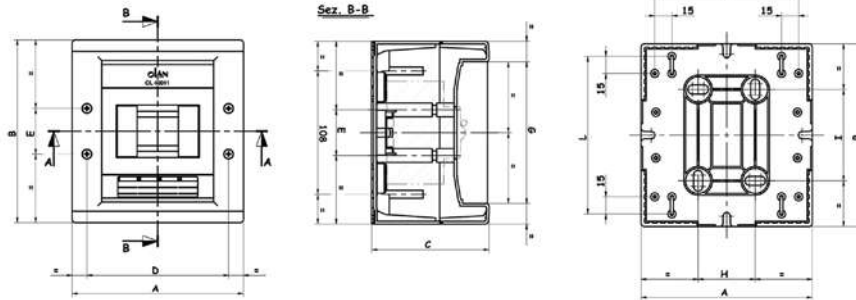

CODE	-A-	-B-	-C-	-D-	-E-	-F-	-G-	-H-	-I-	-L-	-M-
OL40011	150	160	102,5	124	40	98	124	50	80	138	126

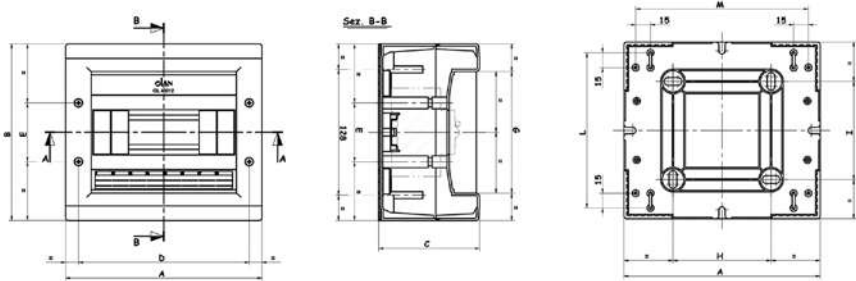

CODE	-A-	-B-	-C-	-D-	-E-	-F-	-G-	-H-	-I-	-L-	-M-
OL40012	200	180	100	174	60	148	124	100	100	158	176

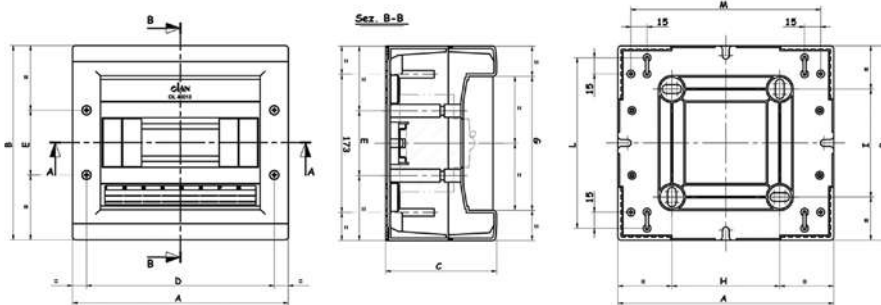

CODE	-A-	-B-	-C-	-D-	-E-	-F-	-G-	-H-	-I-	-L-	-M-
OL40013	280	220	100	254	100	220	124	180	145	203	256

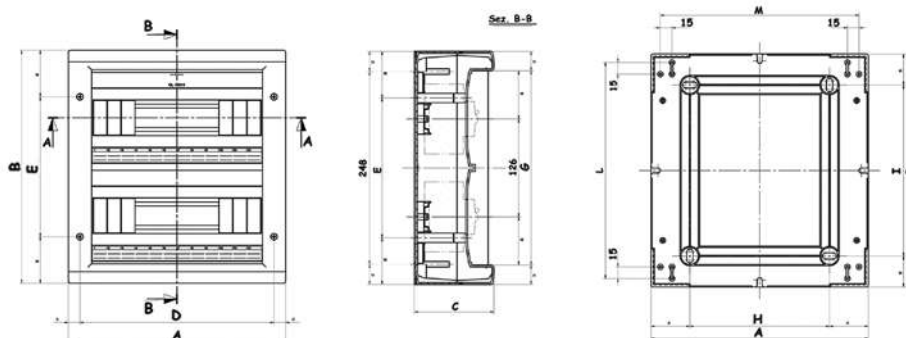

CODE	-A-	-B-	-C-	-D-	-E-	-F-	-G-	-H-	-I-	-L-	-M-
OL40014	280	300	100	250	180	220	250	180	220	278	256

ELECTRICAL EQUIPMENT INSTALLATION / MATÉRIEL ÉLECTRIQUE D'INSTALLATION

FLUSH AND WALL DISTRIBUTION BOARDS - TECHNICAL DATA / COFFRETS DE DISTRIBUTION - CARACTÉRISTIQUES TECHNIQUES

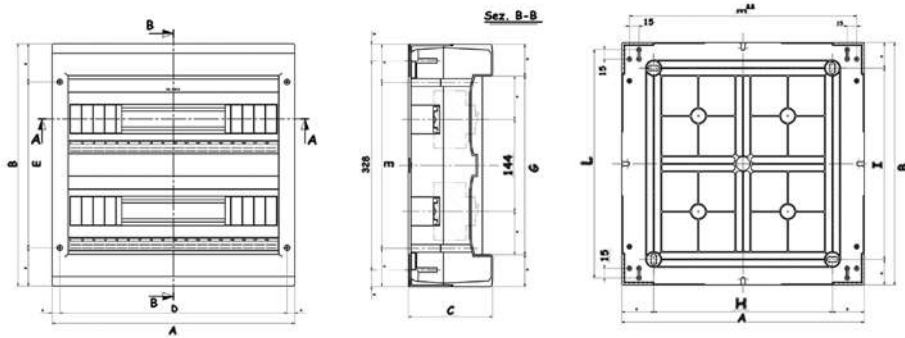

CODE	-A-	-B-	-C-	-D-	-E-	-F-	-G-	-H-	-I-	-L-	-M-
OL40015	380	380	130	356	260	330	280	280	300	358	356

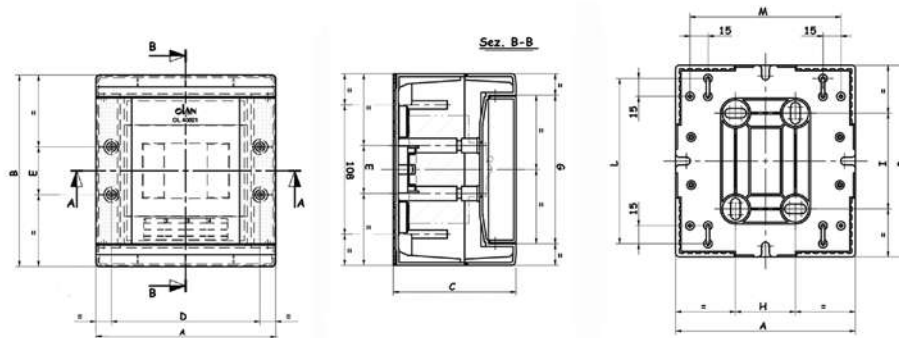

CODE	-A-	-B-	-C-	-D-	-E-	-F-	-G-	-H-	-I-	-L-	-M-
OL40021	150	160	102,5	124	40	98	124	50	80	138	126

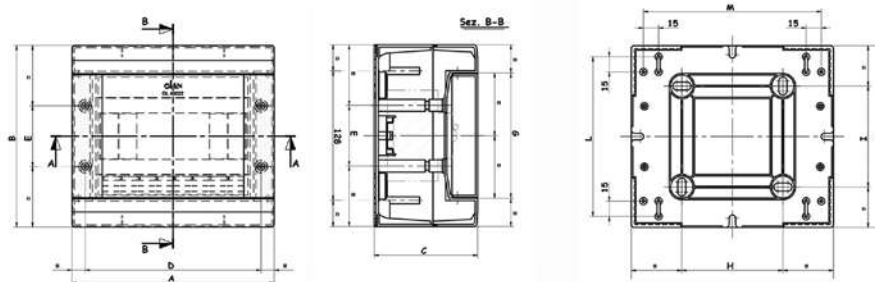

CODE	-A-	-B-	-C-	-D-	-E-	-F-	-G-	-H-	-I-	-L-	-M-
OL40022	200	180	102,5	174	60	148	124	100	100	158	176

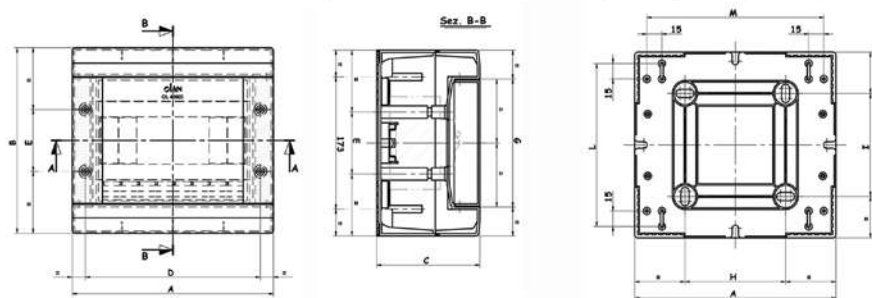

CODE	-A-	-B-	-C-	-D-	-E-	-F-	-G-	-H-	-I-	-L-	-M-
OL40023	280	225	102,5	254	100	220	124	180	145	203	256

ELECTRICAL EQUIPMENT INSTALLATION / MATÉRIEL ÉLECTRIQUE D'INSTALLATION

FLUSH AND WALL DISTRIBUTION BOARDS - TECHNICAL DATA / COFFRETS DE DISTRIBUTION - CARACTÉRISTIQUES TECHNIQUES

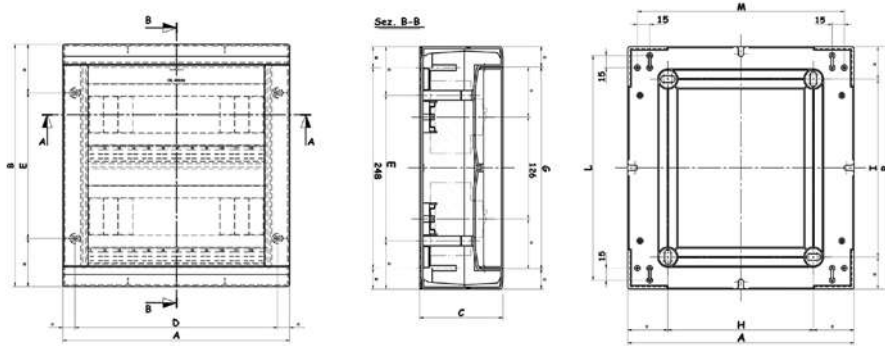

CODE	-A-	-B-	-C-	-D-	-E-	-F-	-G-	-H-	-I-	-L-	-M-
OL40024	280	300	102,5	250	180	220	250	180	220	278	256

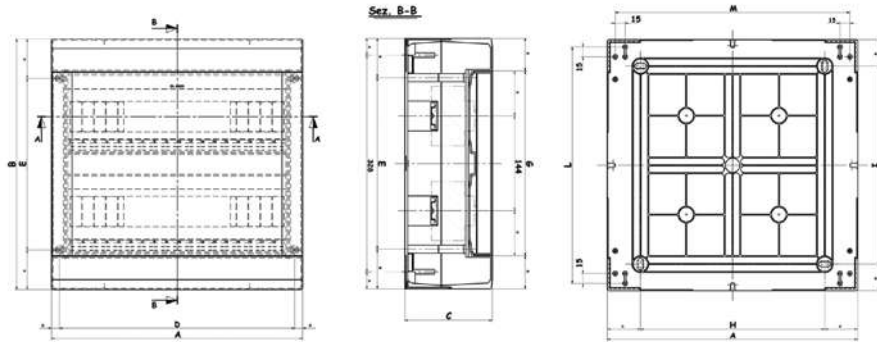

CODE	-A-	-B-	-C-	-D-	-E-	-F-	-G-	-H-	-I-	-L-	-M-
OL40025	380	380	132	356	260	330	280	280	300	358	356

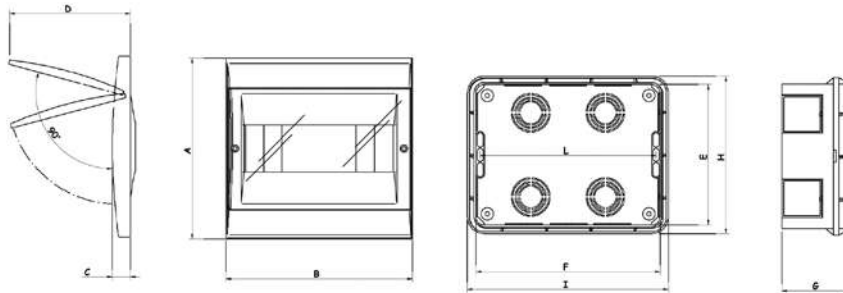

CODE	-A-	-B-	-C-	-D-	-E-	-F-	-G-	-H-	-I-	-L-
OL40211	120	200	21	155	107	182	73	117	195	105

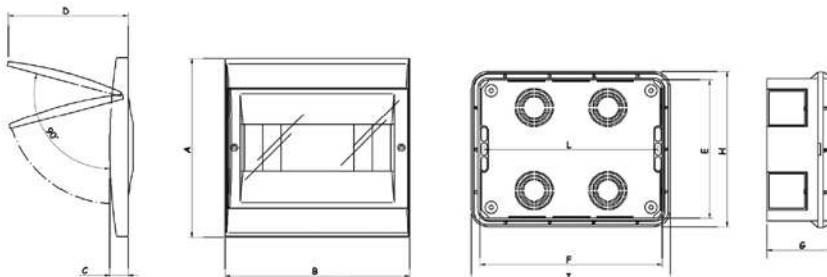

CODE	-A-	-B-	-C-	-D-	-E-	-F-	-G-	-H-	-I-	-L-
OL40212	200	175	21	155	158	178	73	170	195	158

ELECTRICAL EQUIPMENT INSTALLATION / MATÉRIEL ÉLECTRIQUE D'INSTALLATION

FLUSH AND WALL DISTRIBUTION BOARDS - TECHNICAL DATA / COFFRETS DE DISTRIBUTION - CARACTÉRISTIQUES TECHNIQUES

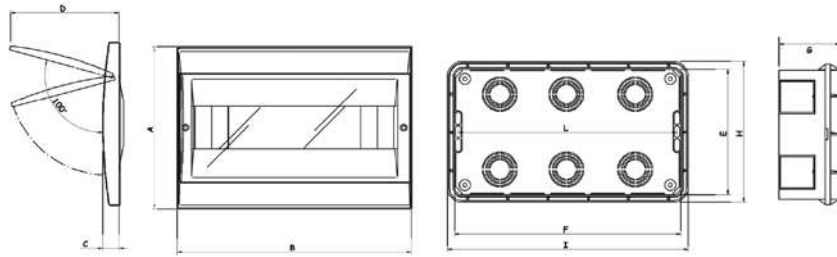

CODE	-A-	-B-	-C-	-D-	-E-	-F-	-G-	-H-	-I-	-L-
OL40213	200	230	21	155	180	215	73	195	225	213

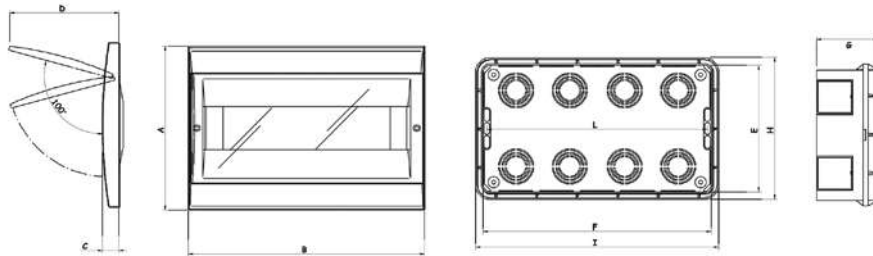

CODE	-A-	-B-	-C-	-D-	-E-	-F-	-G-	-H-	-I-	-L-
OL40214	200	300	21	155	180	290	73	195	300	285

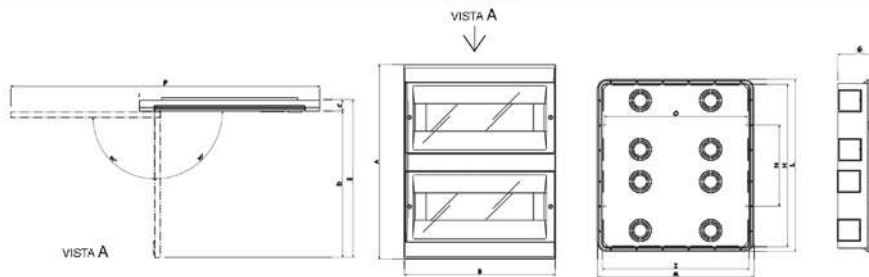

CODE	-A-	-B-	-C-	-D-	-E-	-F-	-G-	-H-	-I-	-L-	-M-	-N-	-O-	-P-
OL40215	400	315	25	320	345	620	80	330	290	345	300	250	280	-

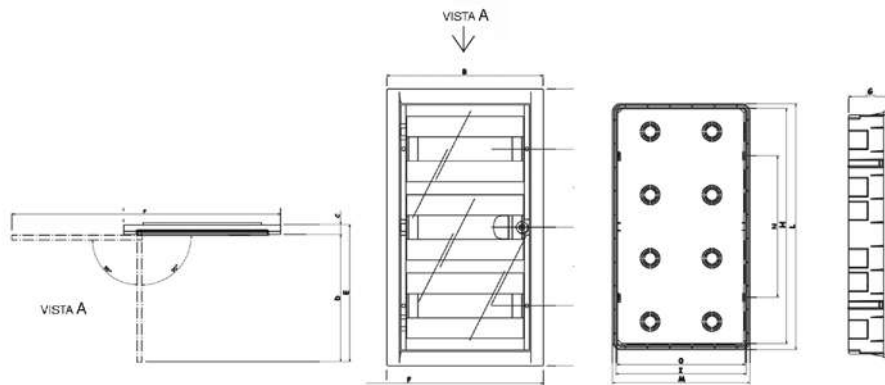

CODE	-A-	-B-	-C-	-D-	-E-	-F-	-G-	-H-	-I-	-L-	-M-	-N-	-O-	-P-
OL40216	525	315	25	325	350	620	80	460	290	480	300	375	280	-

ELECTRICAL EQUIPMENT INSTALLATION / MATÉRIEL ÉLECTRIQUE D'INSTALLATION

FLUSH AND WALL DISTRIBUTION BOARDS - TECHNICAL DATA / COFFRETS DE DISTRIBUTION - CARACTÉRISTIQUES TECHNIQUES

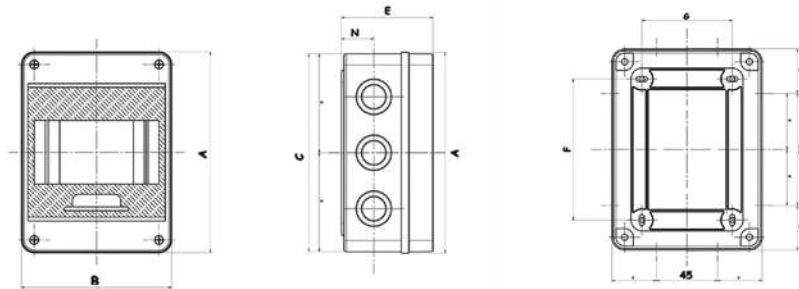

CODE	-A-	-B-	-C-	-D-	-E-	-F-	-G-	-H-	-I-	-L-	-M-	-N-	-O-	-P-
OL40031	160	120	153	113	90	112	72	-	-	-	-	20	52	38

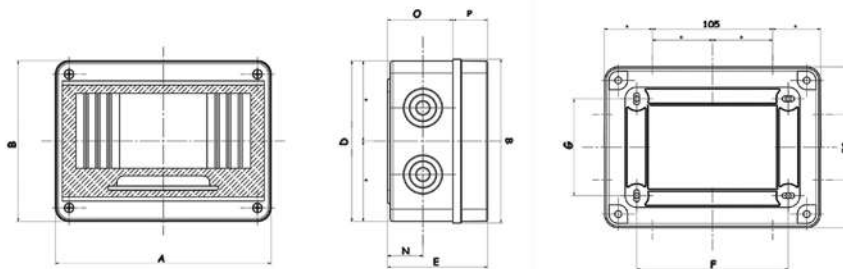

CODE	-A-	-B-	-C-	-D-	-E-	-F-	-G-	-H-	-I-	-L-	-M-	-N-	-O-	-P-
OL40032	200	160	195	150	90	145	97	-	-	-	-	27	52	38

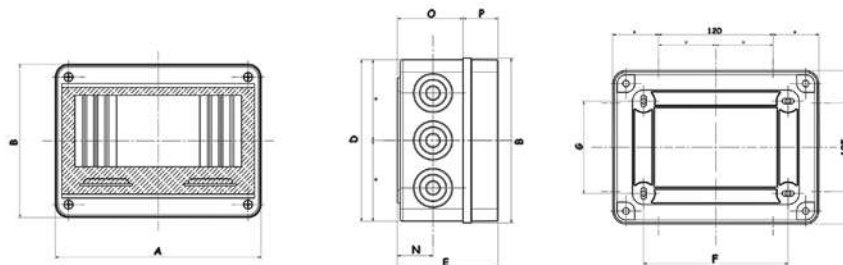

CODE	-A-	-B-	-C-	-D-	-E-	-F-	-G-	-H-	-I-	-L-	-M-	-N-	-O-	-P-
OL40033	250	200	248	198	110	145	97	-	-	-	-	27	68	42

ELECTRICAL EQUIPMENT INSTALLATION / MATÉRIEL ÉLECTRIQUE D'INSTALLATION

FLUSH AND WALL DISTRIBUTION BOARDS - TECHNICAL DATA / COFFRETS DE DISTRIBUTION - CARACTÉRISTIQUES TECHNIQUES

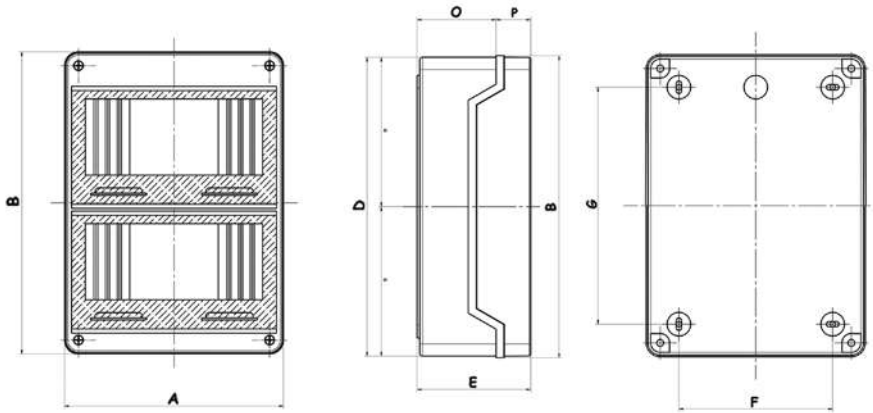

CODE	-A-	-B-	-C-	-D-	-E-	-F-	-G-	-H-	-I-	-L-	-M-	-N-	-O-	-P-
OL40034	250	375	242	365	145	200	250	-	-	-	-	-	90	55

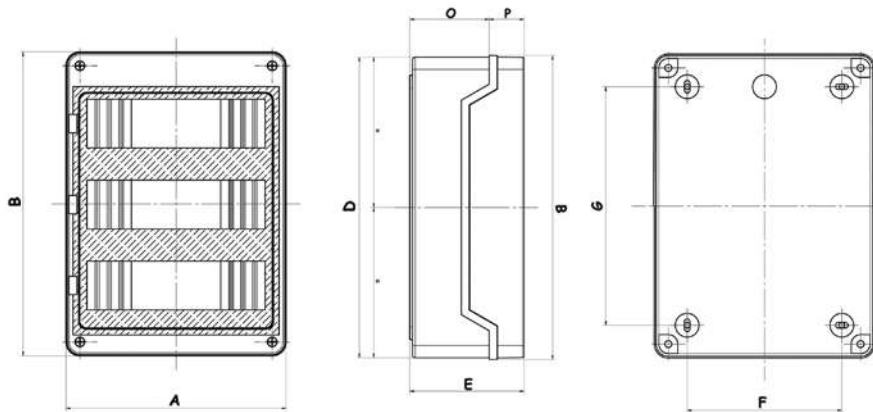

CODE	-A-	-B-	-C-	-D-	-E-	-F-	-G-	-H-	-I-	-L-	-M-	-N-	-O-	-P-
OL40035	355	500	345	490	140	270	380	-	-	-	-	-	90	55

ELECTRICAL EQUIPMENT INSTALLATION / MATÉRIEL ÉLECTRIQUE D'INSTALLATION

CIRCUIT BREAKERS AND FUSE HOLDERS / DISJONCTEURS, BLOCS DIFFÉRENTIELS ET COUPE CIRCUIT

MINIATURE CIRCUIT BREAKERS C CURVE

DISJONCTEURS COURBE C

PI 4,5 KA	Vn 220-240 Vac	CEI EN 60898		
				
CODE RÉFÉRENCE	POLES POLES	In (A)	MODULES MODULES	BOX Pcs. COLIS PCS.
OL 50006	1+N	6	1	12
OL 50010	1+N	10	1	12
OL 50016	1+N	16	1	12
OL 50020	1+N	20	1	12
OL 50025	1+N	25	1	12
OL 50032	1+N	32	1	12

MINIATURE CIRCUIT BREAKERS C CURVE

DISJONCTEURS COURBE C

PI 10 KA	Vn 220-240 Vac	CEI EN 60947-2		
				
CODE RÉFÉRENCE	POLES POLES	In (A)	MODULES MODULES	BOX Pcs. COLIS PCS.
OL 50508	1	80	1,5	12
OL 50510	1	100	1,5	12

MINIATURE CIRCUIT BREAKERS C CURVE

DISJONCTEURS COURBE C

PI 10 KA	Vn 380-415 Vac	CEI EN 60947-2		
				
CODE RÉFÉRENCE	POLES POLES	In (A)	MODULES MODULES	BOX Pcs. COLIS PCS.
OL 50608	2	80	3	6
OL 50610	2	100	3	6
OL 50708	3	80	4,5	4
OL 50710	3	100	4,5	4
OL 50808	4	80	6	3
OL 50810	4	100	6	3

MINIATURE CIRCUIT BREAKERS C CURVE

DISJONCTEURS COURBE C

PI 6 KA	Vn 220-240 Vac			
				
CODE RÉFÉRENCE	POLES POLES	In (A)	MODULES MODULES	BOX Pcs. COLIS PCS.
OL 50101	1	1	1	12
OL 50103	1	3	1	12
OL 50106	1	6	1	12
OL 50110	1	10	1	12
OL 50116	1	16	1	12
OL 50120	1	20	1	12
OL 50125	1	25	1	12
OL 50132	1	32	1	12
OL 50140	1	40	1	12
OL 50150	1	50	1	12
OL 50160	1	63	1	12
OL 50161	1+N	6	2	6
OL 50162	1+N	10	2	6
OL 50163	1+N	16	2	6
OL 50164	1+N	20	2	6
OL 50165	1+N	25	2	6
OL 50166	1+N	32	2	6

MINIATURE CIRCUIT BREAKERS C CURVE

DISJONCTEURS COURBE C

PI 6 KA	Vn 380-415 Vac			
				
CODE RÉFÉRENCE	POLES POLES	In (A)	MODULES MODULES	BOX Pcs. COLIS PCS.
OL 50201	2	1	2	6
OL 50203	2	3	2	6
OL 50206	2	6	2	6
OL 50210	2	10	2	6
OL 50216	2	16	2	6
OL 50220	2	20	2	6
OL 50225	2	25	2	6
OL 50232	2	32	2	6
OL 50240	2	40	2	6
OL 50250	2	50	2	6
OL 50260	2	63	2	6
OL 50301	3	1	3	4
OL 50303	3	3	3	4
OL 50306	3	6	3	4
OL 50310	3	10	3	4
OL 50316	3	16	3	4
OL 50320	3	20	3	4
OL 50325	3	25	3	4
OL 50332	3	32	3	4
OL 50340	3	40	3	4
OL 50350	3	50	3	4
OL 50360	3	63	3	4
OL 50403	4	3	4	3
OL 50405	4	5	4	3
OL 50410	4	10	4	3
OL 50416	4	16	4	3
OL 50420	4	20	4	3
OL 50425	4	25	4	3
OL 50432	4	32	4	3
OL 50440	4	40	4	3
OL 50450	4	50	4	3
OL 50460	4	63	4	3

ELECTRICAL EQUIPMENT INSTALLATION / MATÉRIEL ÉLECTRIQUE D'INSTALLATION

CIRCUIT BREAKERS AND FUSE HOLDERS / DISJONCTEURS, BLOCS DIFFÉRENTIELS ET COUPE CIRCUIT

MINIATURE CIRCUIT BREAKERS D CURVE
DISJONCTEURS COURBE D

PI 6 KA Vn 220-240 Vac



CODE RÉFÉRENCE	POLES POLES	In (A)	MODULES MODULES	BOX Pcs. COLIS PCS.
OL 59101	1	1	1	12
OL 59103	1	3	1	12
OL 59106	1	6	1	12
OL 59110	1	10	1	12
OL 59116	1	16	1	12
OL 59120	1	20	1	12
OL 59125	1	25	1	12
OL 59132	1	32	1	12
OL 59140	1	40	1	12
OL 59150	1	50	1	12
OL 59160	1	63	1	12

MINIATURE CIRCUIT BREAKERS D CURVE
DISJONCTEURS COURBE D

PI 6 KA Vn 380-415 Vac



CODE RÉFÉRENCE	POLES POLES	In (A)	MODULES MODULES	BOX Pcs. COLIS PCS.
OL 59201	2	1	2	6
OL 59203	2	3	2	6
OL 59205	2	5	2	6
OL 59210	2	10	2	6
OL 59215	2	15	2	6
OL 59220	2	20	2	6
OL 59225	2	25	2	6
OL 59232	2	32	2	6
OL 59240	2	40	2	6
OL 59250	2	50	2	6
OL 59260	2	63	2	6
OL 59301	3	1	3	4
OL 59303	3	3	3	4
OL 59305	3	5	3	4
OL 59310	3	10	3	4
OL 59315	3	15	3	4
OL 59320	3	20	3	4
OL 59325	3	25	3	4
OL 59332	3	32	3	4
OL 59340	3	40	3	4
OL 59350	3	50	3	4
OL 59360	3	63	3	4
OL 59403	4	3	4	3
OL 59405	4	5	4	3
OL 59410	4	10	4	3
OL 59415	4	15	4	3
OL 59420	4	20	4	3
OL 59425	4	25	4	3
OL 59432	4	32	4	3
OL 59440	4	40	4	3
OL 59450	4	50	4	3
OL 59460	4	63	4	3

NON AUTOMATIC MCBs
INTERRUPTEURS DE COUPEURE

IP 20

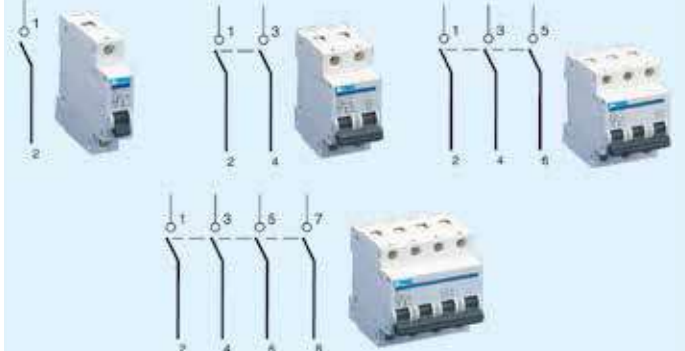

CODE RÉFÉRENCE	POLES POLES	In (A)	MODULES MODULES	BOX Pcs. COLIS PCS.
OL 50910	1	32	1	12
OL 50920	2	32	2	6
OL 50930	3	32	3	4
OL 50940	4	32	4	3

RESIDUAL CURRENT CIRCUIT BREAKERS
DISJONCTEURS DIFFÉRENTIEL

PI 6 KA Vn 240 Vac IP 20



CODE RÉFÉRENCE	POLES POLES	In (A)	mA SENSITIVITY SENSIBILITÉ mA	MODULES MODULES	BOX Pcs. COLIS PCS.
OL 54501	2	25	10	2	1
OL 54503	2	25	30	2	1
OL 54530	2	25	300	2	1
OL 54603	2	40	30	2	1
OL 54613	2	63	30	2	1
OL 54615	2	63	100	2	1
OL 54617	2	63	300	2	1
OL 54630	2	40	300	2	1

PI 6 KA Vn 419 Vac IP 20

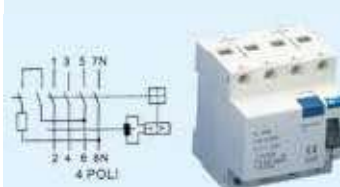

CODE RÉFÉRENCE	POLES POLES	In (A)	mA SENSITIVITY SENSIBILITÉ mA	MODULES MODULES	BOX Pcs. COLIS PCS.
OL 54703	4	40	30	4	1
OL 54713	4	25	300	4	1
OL 54730	4	40	300	4	1
OL 54803	4	63	30	4	1
OL 54830	4	63	300	4	1
OL 54850	4	63	500	4	1

ELECTRICAL EQUIPMENT INSTALLATION / MATÉRIEL ÉLECTRIQUE D'INSTALLATION

CIRCUIT BREAKERS AND FUSE HOLDERS / DISJONCTEURS, BLOCS DIFFÉRENTIELS ET COUPE CIRCUIT

RCCBS WITH OVERCURRENT PROTECTION

DISJONCTEURS DIFFÉRENTIEL

PI 6 KA Vn 220/240 Vac IP 20

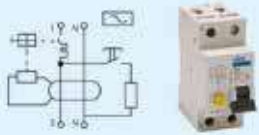

CODE RÉFÉRENCE	POLES POLES	In (A)	mA SENSITIVITY SENSIBILITÉ mA	MODULES MODULES	BOX Pcs. COLIS PCS.
OL 54106	1+N	6	30	2	1
OL 54110	1+N	10	30	2	1
OL 54116	1+N	16	30	2	1
OL 54120	1+N	20	30	2	1
OL 54125	1+N	25	30	2	1
OL 54132	1+N	32	30	2	1

DAILY TIMER SWITCH - STANDBY 150 h

INTERRUPTEUR JOURNALIER - RESERVE DE CHARGE 150 h

Vn 220/240 Vac IP 20

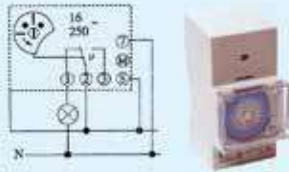

CODE RÉFÉRENCE	POLES POLES	In (A)	MODULES MODULES	BOX Pcs. COLIS PCS.
OL 55520	1	16	3	1

EARTH LEAKAGE CIRCUIT BREAKERS - MANUAL RESETTING

BLOC DIFFÉRENTIELS - REARMEMENT MANUEL

CEI EN 61009-1

Electronic circuitry within the blocks type ISBD can not withstand high test voltages, that's why they must be disconnected in the dielectric tests. / Les circuits électroniques au sein des blocs différentiels type ISBD ne peuvent pas résister à de fortes tensions de test, c'est pourquoi ils doivent être détachés dans les essais diélectriques.



CODE RÉFÉRENCE	POLES POLES	In (A)	mA SENSITIVITY SENSIBILITÉ mA	MODULES MODULES	BOX Pcs. COLIS PCS.
• OL 51203	2	25	30	2	1
• OL 51243	2	40	30	2	1
OL 51245	2	80	30	2	1
OL 51246	2	100	30	2	1
• OL 51230	2	25	300	2	1
• OL 51343	2	40	300	2	1
OL 51344	2	80	300	2	1
OL 51345	2	100	300	2	1
• OL 51403	4	63	30	3,5	1
OL 51404	4	80	30	3,5	1
OL 51405	4	100	30	3,5	1
• OL 51430	4	63	300	3,5	1
OL 51434	4	80	300	3,5	1
OL 51435	4	100	300	3,5	1

• Earth leakage circuit breaker (up to 63A max.) are compatible with MCBs series OL502XX and OL504XX
Bloc différentiel (jusqu'à 63A max.) sont compatibles avec disjoncteurs series OL502XX et OL504XX

RCCBs WITH OVERCURRENT PROTECTION

DISJONCTEURS DIFFÉRENTIEL

PI 6 KA Vn 220-240 Vac IP 20



CODE RÉFÉRENCE	POLES POLES	In (A)	mA SENSITIVITY SENSIBILITÉ mA	MODULES MODULES	BOX Pcs. COLIS PCS.
OL 51210	2	10	30	4	1
OL 51216	2	16	30	4	1
OL 51220	2	20	30	4	1
OL 51225	2	25	30	4	1
OL 51232	2	32	30	4	1
OL 51240	2	40	30	4	1

PI 6 KA Vn380-415 Vac IP 20



CODE RÉFÉRENCE	POLES POLES	In (A)	mA SENSITIVITY SENSIBILITÉ mA	MODULES MODULES	BOX Pcs. COLIS PCS.
OL 51416	4	16	30	7,5	1
OL 51425	4	25	30	7,5	1
OL 51432	4	32	30	7,5	1
OL 51440	4	40	30	7,5	1
OL 51450	4	50	30	7,5	1
OL 51460	4	63	30	7,5	1

ELECTRICAL EQUIPMENT INSTALLATION / MATÉRIEL ÉLECTRIQUE D'INSTALLATION

C. BREAKERS AND FUSE HOLDERS - TECH. DATA/DISJ., BLOCS DIFFÉRENTIELS ET COUPE CIRCUIT - C. TECHNIQUES

CONNECTING RODS BARRETTES DE PONTAGE



CODE RÉFÉRENCE	POLES POLES	MODULES MODULES	BOX Pcs. COLIS PCS.	PACK Pcs. EMB. Pcs.
OL 51141	1	4	10	100
OL 51142	2	4	10	100
OL 51161	1	6	10	100
OL 51162	2	6	10	100
OL 51171	1	24	10	100
OL 51172	2	24	10	100
OL 51173	3	24	10	100
OL 51174	4	24	10	100

FUSE HOLDER COUPE CIRCUIT



CODE RÉFÉRENCE	DIMENSIONS DIMENSIONS	POLES POLES	MODULES MODULES	V MAX In (A)	BOX Pcs. COLIS PCS.	PACK Pcs. EMB. Pcs.
OL 52681	10,3x38	1	1	32	12	96
OL 52682	10,3x38	2	2	32	6	48
OL 52683	10,3x38	3	3	32	4	32
OL 52882	10,3x38	1+N	2	32	6	48
OL 52883	10,3x38	3+N	3	32	3	24
OL 52981	14x51	1	1,5	50	6	36
OL 52982	14x51	2	3	50	6	36
OL 52983	14x51	3	4,5	50	3	36

CIRCUIT BREAKERS 6 KA

POWER DISSIPATION				VARIATION OF THE NOMINAL CURRENT AS A FUNCTION OF TEMPERATURE						
In (A)	TRIPPING CHARACTERISTICS				In (A)	TEMPÉRATURE C°				
	CURVE C		CURVE D			20°	30°	40°	50°	60°
	P(W)	R(mΩ)	P(W)	R(mΩ)						
1	2,0	2000	-	-	1	1,05	1,0	0,96	0,93	0,89
3	2,2	250	-	-	3	3,1	3,0	2,9	2,78	2,66
5										
6	1,4	40	1,0	27,5	6	6,2	6,0	5,8	5,6	5,35
10	1,5	15	1,1	11	10	10,2	10,0	9,6	9,3	8,9
16	1,9	7,5	1,4	5,4	16	16,5	16,0	15,4	14,5	14,1
20	2,2	5,2	1,5	4	20	20,7	20,0	19,0	18,5	17,6
25	2,6	4	2,1	3,2	25	26,0	25,0	24,0	23,0	22,0
32	3	2,9	2,5	2,4	32	33,7	32,0	30,5	29,5	28,5
40	3,6	2,3	3,2	2	40	41,5	40,0	38,1	36,7	35,3
50	4,5	1,8	-	-	50	52,5	50,0	47,3	44,0	40,5
63	5,8	1,4	-	-	63	66,2	63,0	58,0	54,2	48,1

DISJONCTEUR DIFFÉRENTIEL 6KA

PUISSANCE DISSIPÉE				VARIATION DE L'INTENSITÉ NOMINALE EN FONCTION DE LA TEMPÉRATURE						
In (A)	CARACTÉRISTIQUES DE INTERVENTION				In (A)	TEMPÉRATURE C°				
	COURBE C		COURBE D			20°	30°	40°	50°	60°
	P(W)	R(mΩ)	P(W)	R(mΩ)						
1	2,0	2000	-	-	1	1,05	1,0	0,96	0,93	0,89
3	2,2	250	-	-	3	3,1	3,0	2,9	2,78	2,66
5										
6	1,4	40	1,0	27,5	6	6,2	6,0	5,8	5,6	5,35
10	1,5	15	1,1	11	10	10,2	10,0	9,6	9,3	8,9
16	1,9	7,5	1,4	5,4	16	16,5	16,0	15,4	14,5	14,1
20	2,2	5,2	1,5	4	20	20,7	20,0	19,0	18,5	17,6
25	2,6	4	2,1	3,2	25	26,0	25,0	24,0	23,0	22,0
32	3	2,9	2,5	2,4	32	33,7	32,0	30,5	29,5	28,5
40	3,6	2,3	3,2	2	40	41,5	40,0	38,1	36,7	35,3
50	4,5	1,8	-	-	50	52,5	50,0	47,3	44,0	40,5
63	5,8	1,4	-	-	63	66,2	63,0	58,0	54,2	48,1

CIRCUIT BREAKERS 10 KA

POWER DISSIPATION			VARIATION OF THE NOMINAL CURRENT AS A FUNCTION OF TEMPERATURE						
In (A)	TRIPPING CHARACTERISTICS			In (A)	TEMPÉRATURE C°				
	CURVE C				20°	30°	40°	50°	60°
	P(W)	R(mΩ)							
60	7,4	1,3		80	86	80	73,5	66,1	58,1
100	9,6	1,0		100	106,2	100	90,0	78,5	66,3

DISJONCTEUR DIFFÉRENTIEL 10KA

PUISSANCE DISSIPÉE			VARIATION DE L'INTENSITÉ NOMINALE EN FONCTION DE LA TEMPÉRATURE						
In (A)	CARACTÉRISTIQUES DE INTERVENTION			In (A)	TEMPÉRATURE C°				
	COURBE C				20°	30°	40°	50°	60°
	P(W)	R(mΩ)							
60	7,4	1,3		80	86	80	73,5	66,1	58,1
100	9,6	1,0		100	106,2	100	90,0	78,5	66,3

RESIDUAL CURRENT CIRCUIT BREAKER

POWER DISSIPATION		VARIATION OF THE RATED AS A FUNCTION OF TEMPERATURE						
In (A)	TRIPPING CHARACTERISTICS		In (A)	TEMPÉRATURE C°				
	CURVE C			20°	30°	40°	50°	60°
	P(W)							
25	1,3		25	32	30	25	23	20
40	2,88		40	45	44	40	36	32
63	3,81		63	75	70	63	56	50

DISJONCTEUR DIFFÉRENTIEL ELECTRONIQUE DE 10 À 500 mA

PUISSANCE DISSIPÉE		VARIATION DE L'INTENSITÉ NOMINALE EN FONCTION DE LA TEMPÉRATURE						
In (A)	CARACTÉRISTIQUES DE INTERVENTION		In (A)	TEMPÉRATURE C°				
	COURBE C			20°	30°	40°	50°	60°
	P(W)							
25	1,3		25	32	30	25	23	20
40	2,88		40	45	44	40	36	32
63	3,81		63	75	70	63	56	50

ELECTRICAL EQUIPMENT INSTALLATION / MATÉRIEL ÉLECTRIQUE D'INSTALLATION

CIRCUIT BREAKERS AND FUSE HOLDERS - TECHNICAL DATA

AUTOMATIC MAGNETIC AND THERMAL CIRCUIT BREAKERS

Constructional features

The automatic magnetic and thermal circuit breakers of the OLAN range are fitted with two current overload disconnectors, an electromagnetic one for protection against high value current overloads (short circuits) and a (bimetal) thermal one for protection against small value fault currents and overloads.

In the multi-pole versions, the connection is made not only through the disconnection lever, but also through the internal disconnector. The disconnection mechanism is as free disconnection type and, therefore, in the event of a current overload, the circuit breaker is automatically actuated, even if the lever is held in the closed position.

The high circuit breaking power is the result of the perfect combination of the three basic functional elements of the circuit breakers: the circuit breaking chamber, the electromagnetic disconnector and the contacts.

The circuit breaking chamber

It consists of two parts: the pre-chamber and the arc quenching chamber. The former contains the contacts and its function is to guide the arc as quickly as possible towards the arc quenching chamber which, as it incorporates a large number of reeds (eleven), quenches the arc in a very short time.

The electromagnetic disconnector

In the event of a short circuit, it opens the contacts in a very short time (less than one millisecond).

The electric arc that is formed between the contacts, because of their particular shape, is instantaneously guided towards the arc quenching chamber, where it is quenched.

The contacts

Because of their shape and the material, they give to the contacts high-performance functional characteristics:

- high number of mechanical operations
- constant contact quality
- low contact electrical resistance value
- ideal arc trajectory

Nominal use voltages

The nominal use voltage is the voltage value indicated by the maker to which the performance data refers.

Series 5 circuit breakers can be used for operation up to 240V, for the single pole version, and up to 415V, for the multi-pole versions, also for frequencies different from 50/60 Hz.

Nominal current

This is the current value established by the maker that the circuit breaker must support in uninterrupted use with a reference environmental temperature of 30°C, corresponding to the CEI 23-3/4th ed. standard.

With an environmental temperature different from 30°C, the original nominal current value of the circuit breaker must be restored through appropriate corrective measures.

Actuation characteristics "B", "C", "D"

To satisfy the diverse requirements of different installations, the automatic circuit breakers can be supplied with different actuation characteristics.

They are distinguished by the letters B, C and D and have a reference temperature of 30°C.

The thermal actuation area is identical for all three characteristics and is equal to 1.45In, while the non actuation current is equal to 1.13In.

The difference between the different characteristics - B, C and D - concerns the different values characterising the instant actuation area.

They cover a range from 3In to 20In, i.e.:

Actuation curve B:

Actuation curve C:

Actuation curve D:

The circuit breakers are chosen on the basis of their actuation curve.

Curve B

Characteristic B is generally used in the presence of limited value short-circuit currents, when instant circuit breaker actuation is required (e.g., protection of the secondary circuits of transformers).

Curve C

Is the most widely used and is suitable for nearly all electrical circuits. It allows the insertion of loads with high start-up currents without any need to oversize the circuit breakers (e.g., circuit protection in general).

Curve D

Is recommended in the presence of devices with high start-up currents, such as transformers, solenoid valves, motors, etc. With characteristic D, it is not necessary to oversize the circuit breaker (e.g., protection of the primary circuits of transformers).

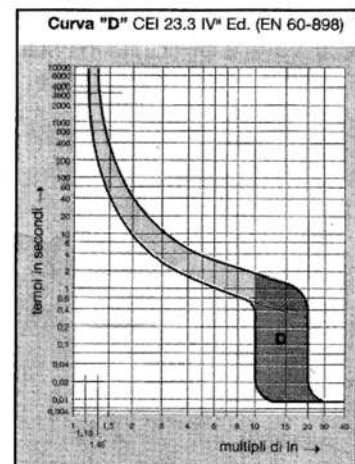
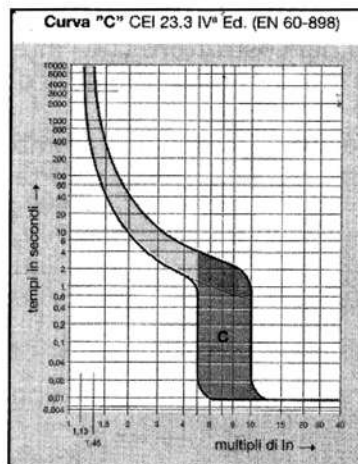
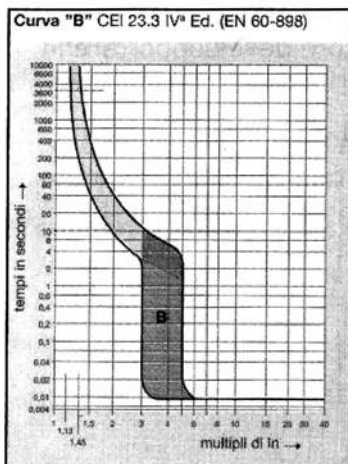

ELECTRICAL EQUIPMENT INSTALLATION / MATÉRIEL ÉLECTRIQUE D'INSTALLATION

CIRCUIT BREAKERS AND FUSE HOLDERS - TECHNICAL DATA

Short-circuit power

The short-circuit power is the value of the alternating component of the assumed current, expressed at its effective value, that the circuit breaker can establish, support for the opening time and interrupt in specific conditions.

It must be at least equal to the assumed three-phase short-circuit current that may occur at the point where it is installed.

Exception: it may be less than the short-circuit current if, haed, there is a device that:

- a) has an interruption power corresponding to the short-circuit current at the point of the network where it is installed;
 - b) limits the specific transitory energy to a value lower than that allowed by the below automatic circuit breaker and the conductors.
- The nominal short-circuit power is the one shown on the front panel of the circuit breaker, as prescribed by CEI standard 23-3/4th ed., and it is represented by a normal value among those defined by the above-mentioned standard. The nominal short-circuit power according to EN60898 must be shown in amperes within a rectangle and without the symbol of the measurement unit. The short-circuit power generally increases as the nominal current of the circuit breaker decreases.

Transitory energy

The function of an automatic circuit breaker is to protect conductors and electrical devices in general against thermal and dynamic stress.

In the event of a short-circuit, the circuit breaker must not let a current passes through, higher than wich one the cable and the device can bear. If a circuit breaker is oversized or in the presence of small section cables, it is necessary to ensure that the short-circuit current at the end of the cables causes the opening of the circuit breaker through the magnetic disconnectors.

Areas of application

Circuit breakers with an interruption power of 6000A are suitable for use in civil installations, in the service sector and in light industry.

The TUV approval obtained by the series 5 automatic circuit breakers for characteristic C, 1, 2, 3 and 4 poles, for systems with nominal voltages of 120/240 V a/c. and 250/415 V a/c., allows the use of these circuit breakers in all the countries of the European Union and in other countries where this approval is recognised.

DIFFERENTIAL CIRCUIT BREAKERS

The differential circuit breaker or residual current differential device is a measurement device associated with a toroid surrounding the active conductors of a circuit and allows the detection of any dispersion current.

In conditions of normal installation operation, that is to say in the absence of insulation defects, the currents passing through the supply conductors are perfectly identical and the resulting flow is equal to zero.

In the presence of a defect (insulation breakage), there will be a dispersal of current.

The differential circuit breaker checks the difference between the "incoming current" and the "outgoing current" and, if necessary, opens the contacts and therefore cuts off the installation from the supply.

The differential circuit breaker may be:

- 1 - an integral part of the interruption device (differential magnetic and thermal circuit breaker)
- 2 - directly associated with the device (magnetic and thermal circuit breaker + differential circuit breaker unit)
- 3 - outside the circuit breaker (differential relay with a separate toroid)

SECTIONABLE MODULAR FUSE HOLDER**General**

The Series 5 modular sectionable fuse holders are devices suitable for housing cylindrical ACR fuses and are used for the protection of electrical circuits, through a cartridge, and for the unloaded sectioning of the circuit itself, using the fuse holder lever.

The multi-pole versions are factory assembled to guarantee safe coupling and, consequently, better equipment operation. The fuse holders are constructed of self-extinguishing insulating material according to IEC 269/2 and VDE 0636 standards.

Technical characteristics

Modular construction with a module of 18 mm.

The large-sized silvered copper clamps allow the safe insertion of the fuse to achieve a better and more stable connection.

The fuse holders are fitted with a sliding catch which, when the fuse is inserted, blocks it from the inside and prevents it from moving, in any heavy-duty installation.

The large-sized cable connection terminals allow the use of conductors with a section up to 35 sq. mm. - Made of insulating and self-extinguishing thermoplastic material, in compliance with standards; heat, shock, weather and U.V. ray resistant.

ELECTRICAL EQUIPMENT INSTALLATION / MATÉRIEL ÉLECTRIQUE D'INSTALLATION

DISJONCTEURS, BLOCS DIFFÉRENTIELS ET COUPE CIRCUIT - CARACTÉRISTIQUES TECHNIQUES

DISJONCTEURS AUTOMATIQUES

Caractéristiques de construction

Les disjoncteurs automatiques de la série Olan sont équipés avec deux déclencheurs: un dispositif pour protéger contre les surtensions de grande valeur (court-circuit), et un thermique (bimétal) pour la protection contre les courants de défaut petites et les surcharges.

Dans les multipolaires la connexion est réalisée non seulement par le levier de libération, mais aussi à travers du déclencheur interne. Le mécanisme de libération est du type libre et donc, dans le cas de surintensité, le commutateur est activé automatiquement aussi avec le levier retenu dans la position fermée. Le haut pouvoir de coupure est le résultat de la combinaison parfaite des trois éléments de base fonctionnelles des commutateurs: la chambre d'interruption, le déclencheur électromagnétique et les contacts.

La chambre de coupure

Elle est constituée par deux parties: la pré-chambre et la chambre de coupure. La première contient des contacts et a pour fonction de diriger le plus rapidement possible l'arc vers la chambre de coupure qui, étant constituée d'un grand nombre de lames (onze), va étendre l'arc très rapidement.

Le déclencheur électromagnétique

Il permet, en cas de court-circuit, l'ouverture des contacts dans un temps très court (moins d'une milliseconde).

L'arc électrique qui s'établit entre les contacts, grâce à leur forme particulière, est poussé instantanément vers la chambre d'extinction et ensuite éteint.

Les contacts

Grâce à leur forme et au matériel avec lequel ils sont construits, ils confèrent aux contacts eux-mêmes des caractéristiques fonctionnelles de haute qualité:

- nombre élevé d'opérations mécaniques
- une qualité constante du contact
- faible valeur de résistance électrique du contact
- la performance idéale de la trajectoire de l'arc.

Tensions nominales de fonctionnement

La tension de fonctionnement est la valeur de tension fournie par le constructeur à laquelle se réfèrent les performances. Les commutateurs de la série 5 sont conçus pour un fonctionnement jusqu'à 240V pour l'unipolaire et jusqu'à 415V pour un multipolaire, même pour des fréquences autres que 50/60 Hz.

Courant nominal

Il s'agit de la valeur actuelle établie par le fabricant que l'interrupteur doit supporter en service sans interruption et à une température ambiante de référence, correspondant à la CEI 23-3/4aed., de 30° C.

Lorsque la température ambiante est différente de 30° C, le courant nominal de l'interrupteur doit être signalé à ce paramètre par le biais de mesures correctives appropriées.

La caractéristique de déclenchement «B», «C», «D»

Pour répondre aux nombreuses exigences pour les systèmes électriques, les disjoncteurs sont disponibles avec des caractéristiques différentes d'intervention.

Celles-ci sont indiquées par les lettres B, C et D et ont leur température de référence 30° C.

La zone du trajet thermique est la même pour toutes les trois caractéristiques, et est égal à 1,45 In, tandis que le courant de non-action est égal à 1,13 In.

La différence entre les caractéristiques B, C et D est dans les différentes valeurs qui caractérisent la zone de déclenchement instantané.

Elles couvrent une plage comprise entre 3In et 20In et précisement:

Déclenchement courbe B: entre 3In et 5In

Courbe de déclenchement C: 10In et 5In

Courbe de déclenchement D entre 10In et 20In

Choix des interrupteurs selon les courbes d'intervention

La courbe B

La caractéristique B est généralement utilisée dans la présence de courants de court-circuit de faible ampleur quand vous voulez le disjoncteur de déclenchement instantané (par exemple: protection des circuits secondaires des transformateurs)

La courbe C

Elle est la plus largement utilisée et peut être employée pour presque tous les circuits électriques.

Permet l'insertion de charges avec des courants de démarrage élevés, sans la nécessité de sur-dimensionner les commutateurs (ex: protection des circuits en général)

La courbe D

Elle est recommandée quand il est en ce qui concerne l'équipement qui ont des courants de démarrage élevés, comme les transformateurs, solénoïdes, moteurs, etc. Avec la caractéristique D n'aurez pas besoin de sur-dimensionner l'interrupteur (par exemple: protection des circuits primaires de transformateurs).

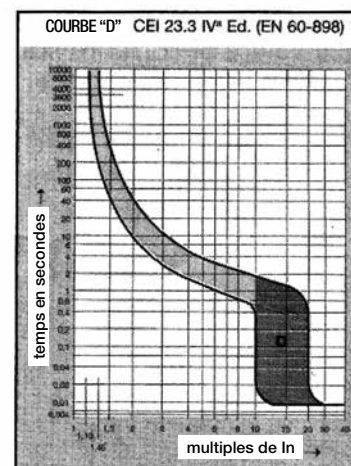
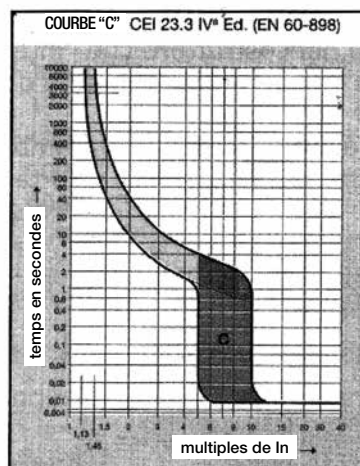
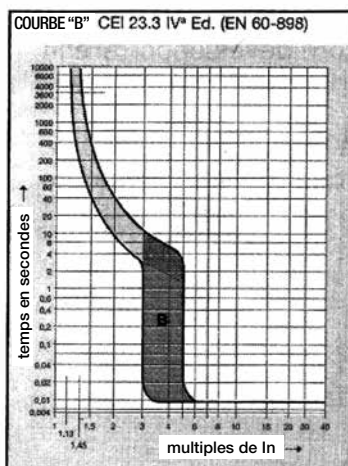

ELECTRICAL EQUIPMENT INSTALLATION / MATÉRIEL ÉLECTRIQUE D'INSTALLATION

DISJONCTEURS, BLOCS DIFFÉRENTIELS ET COUPE CIRCUIT - CARACTÉRISTIQUES TECHNIQUES

Pouvoir de court-circuit

Le pouvoir de court-circuit est la valeur de la composante alternée du courant présumé, exprimée dans sa valeur effective, que le commutateur est en mesure d'établir, résister au temps d'ouverture et d'arrêter dans des conditions spécifiques.

Il doit être au moins égal au courant de court-circuit tri-phasique présumé qui peut se produire à l'endroit où il est installé.

Exception: il peut être inférieur au courant de court-circuit si en amont si il ya un dispositif qui:

- a) a le pouvoir d'interrompre correspondant au courant de court-circuit dans le point où le réseau est installé;
- b) limite l'énergie spécifique passant à une valeur inférieure auquel du disjoncteur en descente des conducteurs.

La puissance de court-circuit nominale est ce qui est montré sur le front de l'interrupteur, tel que requis par la CEI 23-3/4aed., Et elle est représentée par une valeur normale entre ceux qui sont définis par la présente norme. Le pouvoir de court-circuit doit être évalué selon EN60898 signalé en ampères dans un rectangle et non pas le symbole de l'unité de mesure.

Le pouvoir de court-circuit augmente généralement avec la diminution du courant nominal de ladite disjoncteur.

Energie passante

La fonction d'un disjoncteur est de protéger les conducteurs et les appareils électriques en général contre les stress thermiques et dynamiques. En cas de court-circuit l'interrupteur ne doit pas laisser passer un courant plus élevé que celui auquel le câble et l'équipement peut tolérer. Dans le cas où le commutateur est surdimensionné ou en présence de câbles de faible section, il est nécessaire de faire en sorte que le courant de court-circuit à l'extrémité des câbles provoque l'ouverture de l'interrupteur au moyen des déclencheurs magnétiques.

Domaines d'utilisation

Les commutateurs avec pouvoir de coupure de 6000A sont adaptés pour une utilisation en secteur civile, dans le secteur des services et de la petite industrie.

Approbation TUV obtenue à partir de disjoncteurs de la séries 5 pour la caractéristique C 1, 2, 3 & 4, pour le système de tension nominale 120/240V AC et 250/415V c.a. vous permet d'utiliser ces commutateurs dans tous les pays de l'UE et d'autres pays où une telle approbation est accordée.

Disjoncteurs Différentiels

Le différentiel ou disjoncteur différentiel est un dispositif de mesure différentielle associée à un tore qui enveloppe les conducteurs actifs d'un circuit et qui permet de détecter toute fuite de courant. Dans des conditions de fonctionnement normal de l'usine, c'est à dire en l'absence de défauts d'isolation, les courants qui parcourent les conducteurs d'alimentation sont parfaitement identiques, et le flux résultant égal à zéro.

Si une panne survient (isolation cassé ou un contact accidentel) il y aura un courant de défaut.

La différentiel vérifie la différence entre «courant entrant» et «courant sortant» et, si nécessaire, ouvrira les contacts et mettra le système hors de tension.

Le différentiel peut:

- 1 - une partie intégrante de l'appareil de coupure (disjoncteur différentiel)
- 2 - être directement associée à l'appareil (disjoncteur + blocage de différentiel)
- 3 - d'être en dehors du circuit (tore relais différentiel)

Porte-fusibles MODULAIRES**Généralité**

Les porte-fusibles modulaires de la série 5 sont des appareils adaptés pour loger des fusibles cylindriques ACR et ils font la protection des circuits électriques à travers de la cartouche et font l'isolement du, en utilisant la poignée de la porte.

Les exécutions multipolaires sont assemblées dans l'usine pour assurer la sécurité de l'accouplement et, par conséquent, un meilleur actionnement de l'appareil.

Les porte-fusibles sont en matériel isolant à auto-extinction selon les normes IEC269 / 2 et VDE0636.

Caractéristiques

La construction modulaire avec module de 18 mm.

Les pinces en cuivre plaqués argent et la grande taille permettent une connexion sécurisée du fusible pour une meilleure et stable connexion.

Les porte-fusibles sont fournis avec un cliquet qui, à fusible inséré, lui bloque à l'intérieur, en évitant le mouvement, dans n'importe quelle installation lourde.

Les bornes de connexion des câbles, de grands dimensions, permettent l'installation de fils jusqu'à 35 mm².

ELECTRICAL EQUIPMENT INSTALLATION / MATÉRIEL ÉLECTRIQUE D'INSTALLATION

FITTINGS, FASTENINGS, CONNECTORS AND ACCESSORIES / MANCHONS, BARRETTES DE CONNEXIONS ET ACC. DE FIXATION

STRAIGHT WATERTIGHT PIPE-PIPE FITTINGS

MANCHONS ETANCHE TUBE-TUBE

		IP 65	
			
CODE RÉFÉRENCE	Ø	BOX Pcs. COLIS Pcs.	PACK Pcs. EMB. Pcs.
OL 70001	16	50	400
OL 70002	20	50	300
OL 70003	25	50	200
OL 70004	32	25	100
OL 70005	40	20	80
OL 70006	50	10	40

STRAIGHT WATERTIGHT PIPE-BOX FITTINGS

MANCHONS ETANCHE TUBE-BOÎTE

		IP 65	
			
CODE RÉFÉRENCE	Ø	BOX Pcs. COLIS Pcs.	PACK Pcs. EMB. Pcs.
OL 70011	16	50	400
OL 70012	20	50	300
OL 70013	25	50	200
OL 70014	32	25	150
OL 70015	40	25	100
OL 70016	50	15	60

STRAIGHT WATERTIGHT PIPE-HOSE PRESSURE FITTINGS

MANCHONS ETANCHE TUBE-GAINE À PRESSION

		IP 65		
				
CODE RÉFÉRENCE	Ø PIPE Ø TUBE	Ø SHEATH Ø GAINE	BOX Pcs. COLIS Pcs.	PACK Pcs. EMB. Pcs.
OL 70021	16	12	50	400
OL 70022	20	16	50	300
OL 70023	25	20	50	200
OL 70024	32	25	25	100
OL 70025	40	32	20	80
OL 70026	50	40	15	60

STRAIGHT WATERTIGHT PIPE-HOSE PRESSURE FITTINGS,
SAME DIAMETER

MANCHONS ETANCHE TUBE-GAINE À PRESSION DIAMÈTRE IDENTIQUE

		IP 65		
				
CODE RÉFÉRENCE	Ø PIPE Ø TUBE	Ø SHEATH Ø GAINE	BOX Pcs. COLIS Pcs.	PACK Pcs. EMB. Pcs.
OL 70041-S	16	16	50	400
OL 70042-S	20	20	50	300
OL 70043-S	25	25	50	200
OL 70044-S	32	32	25	100
OL 70045-S	40	40	20	80
OL 70046-S	50	50	15	60

STRAIGHT WATERTIGHT PIPE-HOSE FITTINGS WITH FERRULE

MANCHONS ETANCHE TUBE-GAINE AVEC VIROLE

		IP 65		
				
CODE RÉFÉRENCE	Ø PIPE Ø TUBE	Ø SHEATH Ø GAINE	BOX Pcs. COLIS Pcs.	PACK Pcs. EMB. Pcs.
OL 70031	16	12	50	400
OL 70032	20	16	50	300
OL 70033	25	20	50	200
OL 70034	32	25	25	100
OL 70035	40	32	20	80
OL 70036	50	40	15	60

STRAIGHT WATERTIGHT PIPE-HOSE FITTINGS WITH FERRULE,
SAME DIAMETER

MANCHONS ETANCHE TUBE-GAINE AVEC DIAMÈTRE IDENTIQUE

		IP 65		
				
CODE RÉFÉRENCE	Ø PIPE Ø TUBE	Ø SHEATH Ø GAINE	BOX Pcs. COLIS Pcs.	PACK Pcs. EMB. Pcs.
OL 70041	16	16	50	300
OL 70042	20	20	50	200
OL 70043	25	25	25	100
OL 70044	32	32	20	80
OL 70045	40	40	15	60
OL 70046	50	50	10	60

ELECTRICAL EQUIPMENT INSTALLATION / MATÉRIEL ÉLECTRIQUE D'INSTALLATION

FITTINGS, FASTENINGS, CONNECTORS AND ACCESSORIES / MANCHONS, BARRETTES DE CONNEXIONS ET ACC. DE FIXATION

STRAIGHT WATERTIGHT BOX-HOSE FITTINGS, METRIC THREAD
MANCHONS IRL ETANCHE BOÎTE-GAINE, PAS MÉTRIQUE

IP 65



CODE RÉFÉRENCE	Ø SHEATH Ø GAINE	BOX Pcs. COLIS Pcs.	PACK Pcs. EMB. Pcs.
OL 70049	10	100	800
OL 70051	12	100	800
OL 70050	14	50	800
OL 70052	16	50	400
OL 70053	20	50	300
OL 70054	25	25	150
OL 70055	32	25	100
OL 70056	40	20	60
OL 70057	50	10	60

WATERTIGHT PIPE-BOX FLEXIBLE BENDS
COUDES FLEXIBLE ETANCHE GAINE-BOÎTE

IP 65



CODE RÉFÉRENCE	Ø	LENGTH LONGUEUR	BOX Pcs. COLIS Pcs.	PACK Pcs. EMB. Pcs.
OL 70081	16	215	20	80
OL 70082	20	240	20	80
OL 70083	25	260	20	60
OL 70084	32	280	20	60
OL 70085	40	305	10	30
OL 70086	50	310	10	20

WATERTIGHT 90° BENDS
COUDES OUVRABLE

IP 65



CODE RÉFÉRENCE	Ø	BOX Pcs. COLIS Pcs.	PACK Pcs. EMB. Pcs.
OL 70061	16	50	300
OL 70062	20	50	200
OL 70063	25	25	100
OL 70064	32	25	50
OL 70065	40	10	30
OL 70066	50	5	15

STRAIGHT PIPE JOINTS
MANCHONS POUR TUBE IRL

IP 40



CODE	Ø	BOX Pcs. COLIS Pcs.	PACK Pcs. EMB. Pcs.
OL 70091	16	100	600
OL 70092	20	100	400
OL 70093	25	50	300
OL 70094	32	25	150
OL 70095	40	20	80
OL 70096	50	20	60

FLEXIBLE WATERTIGHT PIPE-PIPE CONDUIT BENDS
COUDES FLEXIBLE ETANCHE TUBE-TUBE

IP 65



CODE RÉFÉRENCE	Ø	LENGTH LONGUEUR	BOX Pcs. COLIS Pcs.	PACK Pcs. EMB. Pcs.
OL 70071	16	215	20	80
OL 70072	20	240	20	80
OL 70073	25	260	20	60
OL 70074	32	280	20	60
OL 70075	40	305	10	30
OL 70076	50	310	10	20

90° INSPECTION BENDS
COUDES OUVRABLE 90°

IP40



CODE RÉFÉRENCE	Ø	BOX Pcs. COLIS Pcs.	PACK Pcs. EMB. Pcs.
OL 70101	16	50	600
OL 70102	20	50	300
OL 70103	25	50	200
OL 70104	32	50	100

ELECTRICAL EQUIPMENT INSTALLATION / MATÉRIEL ÉLECTRIQUE D'INSTALLATION

FITTINGS, FASTENINGS, CONNECTORS AND ACCESSORIES / MANCHONS, BARRETTES DE CONNEXIONS ET ACC. DE FIXATION

NARROW RADIUS 90° BENDS WITH CYLINDRICAL MOUTHS
COUDES GRAND RAYON 90°

IP40			
			
CODE RÉFÉRENCE	Ø	BOX Pcs. COLIS Pcs.	PACK Pcs. EMB. Pcs.
OL 70121	16	50	400
OL 70122	20	50	200
OL 70123	25	25	100
OL 70124	32	25	50
OL 70125	40	10	30
OL 70126	50	5	20

"T" INSPECTION JOINTS
JOINTS EN T CONTRÔLABLE

IP40			
			
CODE RÉFÉRENCE	Ø	BOX Pcs. COLIS Pcs.	PACK Pcs. EMB. Pcs.
OL 70131	16	50	300
OL 70132	20	50	200
OL 70133	25	50	100
OL 70134	32	50	100

CABLE GLANDS, PG THREAD
PRESSE ÉTOUPE PAS PG AVEC CONTRE ÉCROU MONTÉ

IP40					
					
CODE RÉFÉRENCE	PG THREAD PAS PG	Ø CABLE	Ø FIXING HOLE (RECOMMENDED) Ø TROU DE FIXATION (RECOMMANDÉ)	BOX Pcs. COLIS Pcs.	PACK Pcs. EMB. Pcs.
OL 70141	PG7	3,5 ÷ 6,5	12	100	500
OL 70142	PG9	4 ÷ 8	16	100	400
OL 70143	PG11	5 ÷ 10	18	100	400
OL 70144	PG13,5	6 ÷ 12	20	100	400
OL 70145	PG16	10 ÷ 14	22	100	200
OL 70146	PG21	13 ÷ 18	26,5	50	100
OL 70147	PG29	18 ÷ 25	35,5	50	100
OL 70148	PG36	25 ÷ 33	47	25	50
OL 70149	PG42	30 ÷ 38	54	10	50
OL 70150	PG48	34 ÷ 43	60	5	40

BLACK PG CABLE GLAND
PRESSE-ÉTOUPE PG - NOIR

IP40					
					
CODE RÉFÉRENCE	PG THREAD PAS PG	Ø CABLE	Ø FIXING HOLE (RECOMMENDED) Ø TROU DE FIXATION (RECOMMANDÉ)	BOX Pcs. COLIS Pcs.	PACK Pcs. EMB. Pcs.
OL70141N	PG7	3,5 ÷ 6,5	12	100	500
OL70142N	PG9	4 ÷ 8	16	100	400
OL70143N	PG11	5 ÷ 10	18	100	400
OL70144N	PG13,5	6 ÷ 12	20	100	400
OL70145N	PG16	10 ÷ 14	22	100	200
OL70146N	PG21	13 ÷ 18	26,5	50	100
OL70147N	PG29	18 ÷ 25	35,5	50	100
OL70148N	PG36	25 ÷ 33	47	25	50
OL70149N	PG42	30 ÷ 38	54	10	50
OL70150N	PG48	34 ÷ 43	60	5	40

NEW
NOUVELLESSEALS FOR PG CABLE GLAND
SEALS POUR PRESSE-ÉTOUPE PG

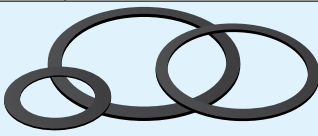
IP 65			
			
CODE RÉFÉRENCE	PG THREAD PAS PG	BOX Pcs. COLIS Pcs.	PACK Pcs. EMB. Pcs.
OL71141	PG7	100	500
OL71142	PG9	100	400
OL71143	PG11	100	400
OL71144	PG13,5	100	400
OL71145	PG16	100	200
OL71146	PG21	50	100
OL71147	PG29	50	100
OL71148	PG36	25	50
OL71149	PG42	10	50
OL71150	PG48	5	40

PIPE FIXING CLIPS
CLIPS FIXE-TUBE

HALOGEN FREE SANS HALOGENES			
			
CODE RÉFÉRENCE	Ø	BOX Pcs. COLIS Pcs.	PACK Pcs. EMB. Pcs.
OL 70151	16	100	2000
OL 70152	20	100	2000
OL 70153	25	100	1200
OL 70154	32	100	800
OL 70155	40	50	300
OL 70156	50	25	150

ELECTRICAL EQUIPMENT INSTALLATION / MATÉRIEL ÉLECTRIQUE D'INSTALLATION

FITTINGS, FASTENINGS, CONNECTORS AND ACCESSORIES / MANCHONS, BARRETTES DE CONNEXIONS ET ACC. DE FIXATION

CLIPS RAIL

RAIL DE FIXATION POUR CLIPS FIXE-TUBE



CODE RÉFÉRENCE	LENGTH LONGUEUR	PACK Pcs. EMB. Pcs.
OL 70161	200	50

SNAP-ON PIPE CLAMPS

CLIPS FIXE-TUBE FERMETURE À PRESSION



CODE RÉFÉRENCE	Ø	BOX Pcs. COLIS Pcs.	PACK Pcs. EMB. Pcs.
OL 70171	13/21	100	600
OL 70172	23/35	50	400
OL 70173	38/50	50	200

PIPE FIXING STRIP

COLLIERS EXTENSIBLE FIXE TUBE

HALOGEN FREE
SANS HALOGENES

CODE RÉFÉRENCE	Ø	RESISTANCE TO TRACTION RÉSISTANCE À LA TRACTION	BOX Pcs. COLIS Pcs.	PACK Pcs. EMB. Pcs.
OL 70176	13-32	18 Kg	100	1000
OL 70177	40-63	18 Kg	100	500

THERMOPLASTIC ROUND CLIP WITH NAIL

AGRAFE PLASTIQUE POUR CABLES



CODE RÉFÉRENCE	Ø	COLOUR COULEUR	BOX Pcs. COLIS Pcs.	PACK Pcs. EMB. Pcs.
OL 70181	3/4		100	10000
OL 70182	5/6		100	10000
OL 70183	7/8		100	10000
OL 70184	9/10		100	10000
OL 70185	11/12		100	5000
OL 70186	13/14		100	4000
OL 70187	15/16		100	3000
OL 70188	19/20		100	2000
OL 70189	21/22		100	1000
OL 70190	24/25		50	800
OL 70191	31/32		50	500

THERMOPLASTIC ROUND CLIP WITH NAIL

AGRAFE PLASTIQUE POUR CABLES



CODE RÉFÉRENCE	Ø	COLOUR COULEUR	BOX Pcs. COLIS Pcs.	PACK Pcs. EMB. Pcs.
OL 70211	3/4		100	10000
OL 70212	5/6		100	10000
OL 70213	7/8		100	10000
OL 70214	9/10		100	10000
OL 70215	11/12		100	5000
OL 70216	13/14		100	4000
OL 70217	15/16		100	3000
OL 70218	19/20		100	2000
OL 70219	21/22		100	1000
OL 70220	24/25		50	800
OL 70221	31/32		50	500

THERMOPLASTIC NAIL CLIP FOR TV CABLE

AGRAFE PLASTIQUE POUR CABLE TV



CODE RÉFÉRENCE	Ø	COLOUR COULEUR	BOX Pcs. COLIS Pcs.	PACK Pcs. EMB. Pcs.
OL 70225	7		100	10000

THERMOPLASTIC ROUND CLIP WITH NAIL

AGRAFE PLASTIQUE POUR CABLES



CODE RÉFÉRENCE	Ø	COLOUR COULEUR	BOX Pcs. COLIS Pcs.	PACK Pcs. EMB. Pcs.
OL 70231	5/6		100	10000
OL 70232	7/8		100	10000
OL 70233	10/11		100	10000
OL 70241	5/6		100	10000
OL 70242	7/8		100	10000
OL 70243	10/11		100	10000

ELTEX SCREW PLUG

CHEVILLE EN ELTEX



CODE RÉFÉRENCE	Ø	BOX Pcs. COLIS Pcs.	PACK Pcs. EMB. Pcs.
OL 70261	4	100	5000
OL 70262	5	100	5000
OL 70263	6	100	5000
OL 70265	8	100	5000
OL 70266	10	100	3000

ELECTRICAL EQUIPMENT INSTALLATION / MATÉRIEL ÉLECTRIQUE D'INSTALLATION

FITTINGS, FASTENINGS, CONNECTORS AND ACCESSORIES / MANCHONS, BARRETTES DE CONNEXIONS ET ACC. DE FIXATION

ELTEX DOWEL WITH SCREW

CHEVILLE AVEC VIS EN ELTEX



CODE RÉFÉRENCE	Ø	BOX Pcs. COLIS Pcs.	PACK Pcs. EMB. Pcs.
OL 70281	4	100	3000
OL 70282	5	100	2500
OL 70283	6	100	2500
OL 70285	8	100	2500
OL 70286	10	100	900

POLYCARBONATE CONNECTORS FOR BOXES
IN 10 SEPARATE TERMINAL STRIPS

BORNES EN POLYCARBONATE POUR BOÎTES BARREAU DE 10 PIEC. A SECTIONNER



CODE RÉFÉRENCE	DIMENSIONS mm ² DIMENSIONS mm ²	COLOUR COULEUR	BOX Pcs. COLIS Pcs.	PACK Pcs. EMB. Pcs.
OL 70406	1,5	T	10	200
OL 70407	2,5	T	10	200
OL 70408	4	T	10	200
OL 70409	6	T	10	200
OL 70410	10	T	10	200
OL 70411	16	T	10	200

T = Transparent

DIVISIBLE CONNECTORS 12 POLES POLYPROPYLENE

BORNES SECTIONNABLES 12 POLES EN POLYPROPYLENE

80°C - 440V



CODE RÉFÉRENCE	DIMENSIONS mm ² DIMENSIONS mm ²	COLOUR COULEUR	BOX Pcs. COLIS Pcs.
OL70425B	2,5-4	□	10
OL70425N	2,5-4	■	10
OL70426B	4-6	□	10
OL70426N	4-6	■	10
OL70427B	6-10	□	10
OL70427N	6-10	■	10
OL70428B	16	□	10
OL70428N	16	■	10
OL70429B	25	□	10
OL70429N	25	■	10

POLYAMIDE 6.6 CLASS V2 CABLE TIES

COLLIER DE CÂBLAGE EN POLYAMIDE 6.6 CLASSE V2



CODE RÉFÉRENCE	DIMENSIONS DIMENSIONS	RESISTANCE TO TRACTION RÉSISTANCE À LA TRACTION	COLOUR COULEUR	BOX Pcs. COLIS Pcs.	PACK Pcs. EMB. Pcs.
OL 70300	120x2,5	8	N	100	3000
OL 70301	80x2,2	8	N	100	3000
OL 70302	100x2,5	8,2	N	100	3000
OL 70303	180x2,5	8,2	N	100	3000
OL 70304	200x2,5	8,2	N	100	3000
OL 70305	140x3,5	13,5	N	100	2000
OL 70306	200x3,5	13,5	N	100	2000
OL 70307	300x3,5	13,5	N	100	2000
OL 70308	370x3,5	13,5	N	100	1000
OL 70309	180x4,5	22,6	N	100	1000
OL 70310	200x4,5	22,6	N	100	3000
OL 70311	250x4,5	22,6	N	100	3000
OL 70312	280x4,5	22,6	N	100	2000
OL 70313	350x4,5	22,6	N	100	1000
OL 70314	250x7,5	56	N	100	1000
OL 70315	300x7,5	56	N	100	1000
OL 70316	450x7,5	56	N	100	1000
OL 70319	550x9	80	N	100	1000
OL 70320	760x9	80	N	100	1000
OL 70340	120x2,5	8	■	100	3000
OL 70341	80x2,2	8	■	100	3000
OL 70342	100x2,5	8,2	■	100	3000
OL 70343	180x2,5	8,2	■	100	3000
OL 70344	200x2,5	8,2	■	100	3000
OL 70345	140x3,5	13,5	■	100	2000
OL 70346	200x3,5	13,5	■	100	2000
OL 70347	300x3,5	13,5	■	100	2000
OL 70348	370x3,5	13,5	■	100	2000
OL 70349	180x4,5	22,6	■	100	1000
OL 70350	200x4,5	22,6	■	100	3000
OL 70351	250x4,5	22,6	■	100	3000
OL 70352	280x4,5	22,6	■	100	2000
OL 70353	350x4,5	22,6	■	100	1000
OL 70354	250x7,5	56	■	100	1000
OL 70355	300x7,5	56	■	100	1000
OL 70356	450x7,5	56	■	100	1000
OL 70359	550x9	80	■	100	1000
OL 70360	760x9	80	■	100	1000

N = Neutre

COLLARS CONNECTION PIN

PIVOT DE CONNEXION POUR COLLIER



CODE RÉFÉRENCE	BOX Pcs. COLIS Pcs.	PACK Pcs. EMB. Pcs.
OL 70401	100	1000

ELECTRICAL EQUIPMENT INSTALLATION / MATÉRIEL ÉLECTRIQUE D'INSTALLATION

FITTINGS, FASTENINGS, CONNECTORS AND ACCESSORIES / MANCHONS, BARRETTES DE CONNEXIONS ET ACC. DE FIXATION

ADHESIVE TIE MOUNTS

EMBASE ADHÉSIVE POUR COLLIER DE CÂBLAGE



CODE RÉFÉRENCE	DIMENSIONS DIMENSIONS	COLOUR COULEUR	BOX Pcs. COLIS Pcs.	PACK Pcs. EMB. Pcs.
OL 70380	19x19		100	3000
OL 70381	25x25		100	3000
OL 70382	30x30		100	3000
OL 70383	40x40		100	3000
OL 70384	19x19		100	3000
OL 70385	25x25		100	3000
OL 70386	30x30		100	3000
OL 70387	40x40		100	3000

ZINC-COATED ONE HOLE HEAVY-DUTY COLLAR

COLLIER RENFORCÉ EN METAL ZINGUÉ AVEC 1 TROU



CODE RÉFÉRENCE	Ø PIPE Ø TUBE	BOX Pcs. COLIS Pcs.	PACK Pcs. EMB. Pcs.
OL 70461	10/11	100	1500
OL 70462	13/14	100	1500
OL 70463	16/17	100	1500
OL 70464	19/20	100	1200
OL 70465	21/22	100	1600
OL 70466	25/26	100	1600
OL 70467	31/32	100	1000
OL 70468	38/40	50	500
OL 70469	48/50	50	500

ZINC-COATED STEEL COLLAR WITH 2 SCREWS

COLLIER EN METAL ZINGUÉ AVEC 2 VIS



CODE RÉFÉRENCE	Ø PIPE Ø TUBE	BOX Pcs. COLIS Pcs.	PACK Pcs. EMB. Pcs.
OL 70391	10/11	100	1500
OL 70392	12/13	100	1200
OL 70393	14/15	100	1200
OL 70394	16/17	100	1000
OL 70395	19/20	100	800
OL 70396	21/22	100	800
OL 70397	25/26	100	800
OL 70398	31/32	100	1000
OL 70399	38/40	50	600
OL 70400	48/50	50	600

ZINC-COATED ONE HOLE LIGHT-DUTY COLLAR

COLLIER EN METAL ZINGUÉ AVEC 1 TROU



CODE RÉFÉRENCE	Ø PIPE Ø TUBE	BOX Pcs. COLIS Pcs.	PACK Pcs. EMB. Pcs.
OL 70481	7/8	100	2000
OL 70482	10/11	100	1500
OL 70483	13/14	100	1500
OL 70484	16/17	100	1500
OL 70485	19/20	100	1500
OL 70486	21/22	100	1500
OL 70487	25/26	100	1500

ZINC-COATED STEEL 2 HOLE U-COLLAR

COLLIER EN METAL ZINGUÉ AVEC 2 TROUS



CODE RÉFÉRENCE	Ø PIPE Ø TUBE	BOX Pcs. COLIS Pcs.	PACK Pcs. EMB. Pcs.
OL 70441	10	100	1500
OL 70442	12	100	1500
OL 70443	16	100	1500
OL 70444	20	100	1200
OL 70445	22	100	1600
OL 70446	25	100	1600
OL 70447	32	100	1000
OL 70448	40	50	500
OL 70449	50	50	500

ELECTRICAL EQUIPMENT INSTALLATION / MATÉRIEL ÉLECTRIQUE D'INSTALLATION

FITTINGS, FASTENINGS AND CONNECTORS - TECH.DATA/MANCHONS, BARRETTES DE CONNEXIONS - CARACT. TECHNIQUES

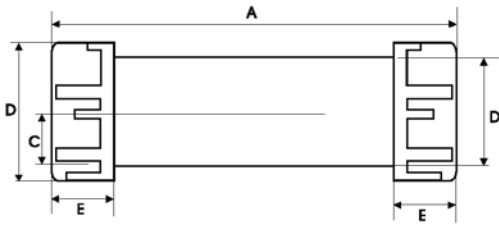

CODE	PIPE Ø	A	B	C	D	E
OL70001	16	88,5	18,8	16,2	24,1	11,8
OL70002	20	88,5	22,8	20,2	28,2	12,3
OL70003	25	88,5	28,2	25,3	33,7	13,3
OL70004	32	88,5	35,5	32,3	40,7	16,4
OL70005	40	108,5	44	40,3	49,5	16,6
OL70006	50	108,5	54	50,4	59,5	16,6

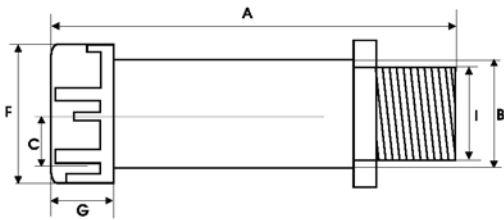

CODE	PIPE Ø	A	B	C	D	E	F	G
OL70011	16	61,7	18,8	16,2	16x1,5	10,5	24,1	11,8
OL70012	20	64,7	22,8	20,3	20x1,5	13,5	28,2	12,3
OL70013	25	65,2	28,2	25,3	25x1,5	13,5	33,7	13,3
OL70014	32	79,2	35,5	32,3	32x1,5	17,0	40,7	16,4
OL70015	40	80,5	44,1	40,3	40x1,5	18,0	49,5	16,6
OL70016	50	82,7	54,2	50,3	50x1,5	19,5	59,5	16,6

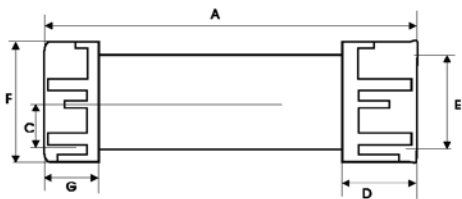

CODE	PIPE Ø	SHEATH Ø	A	B	C	D	E	F	G
OL70021	16	12	62,0	19,7	16,2	23	11,8	23,0	12,0
OL70022	20	16	64,0	23,8	20,2	25	15,5	27	12,5
OL70023	25	20	67,0	29,0	25,2	27	19,7	32,2	13,2
OL70024	32	25	80,0	34,7	32,2	28	24,5	39,5	16,5
OL70025	40	32	82,0	44,8	40,2	33	31,5	48,7	16,5
OL70026	50	40	85,0	50,8	50,3	35,5	39,8	58,0	16,5

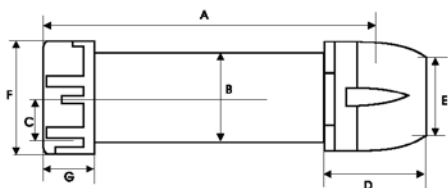

CODE	PIPE Ø	SHEATH Ø	A	B	C	D	E	F	G
OL70031	16	12	75	20	16,2	27	11,8	23,2	12,1
OL70032	20	16	77	23	20,2	31	15,8	27,2	12,5
OL70033	25	20	84	28	25,3	39	19,8	32,2	13,2
OL70034	32	25	95	35	32,3	41	24,7	40,2	16,3
OL70035	40	32	96	44	40,3	41,2	31,7	49,5	17,0
OL70036	50	40	96	54	50,3	43,1	39,7	58,1	17,0

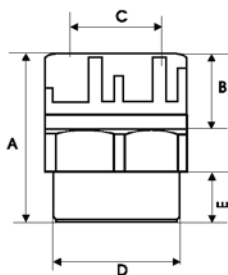

CODE	SHEATH Ø	A	B	C	D	E
OL70051	12	40,0	22,0	12	16x1,5	3/8
OL70052	16	46,2	25,0	16	20x1,5	1/2
OL70053	20	49,8	28,0	20	25x1,5	3/4
OL70054	25	57,3	31,0	25	32x1,5	1"
OL70055	32	61,3	33,0	32	40x1,5	1 1/4
OL70056	40	66,3	36,0	40	50x1,5	1 1/2
OL70057	50	67,3	36,0	50	63x1,5	2"

ELECTRICAL EQUIPMENT INSTALLATION / MATÉRIEL ÉLECTRIQUE D'INSTALLATION

FITTINGS, FASTENINGS AND CONNECTORS - TECH.DATA/MANCHONS, BARRETTES DE CONNEXIONS - CARACT. TECHNIQUES

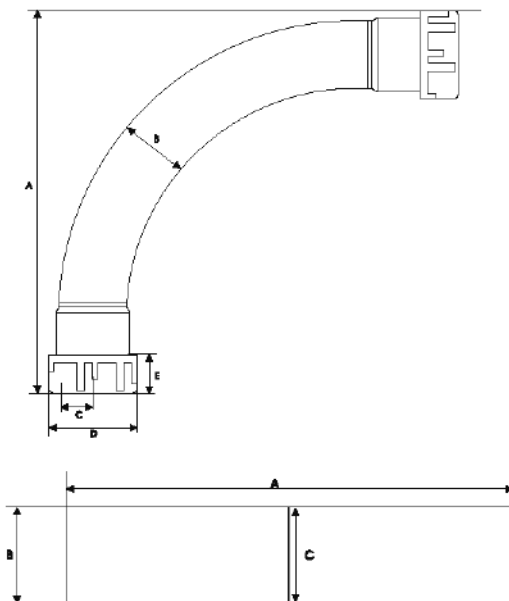

CODE	PIPE Ø	A	B	C	D	E
OL70061	16	66,7	16	16	24,1	11,8
OL70062	20	82,2	20	20	28,2	12,3
OL70063	25	102,0	25	25	33,7	13,3
OL70064	32	127,5	32	32	40,7	16,4
OL70065	40	162,0	40	40	49,5	16,6
OL70066	50	201,0	50	50	59,5	16,6

CODE	PIPE Ø	A	B	C	D
OL70091	16	80	16,3	15,9	18,8
OL70092	20	80	20,5	19,9	22,8
OL70093	25	80	25,3	24,9	28,2
OL70094	32	100	32,5	31,9	31,5
OL70095	40	100	40,3	39,9	44,0
OL70096	50	100	50,3	49,9	54,0

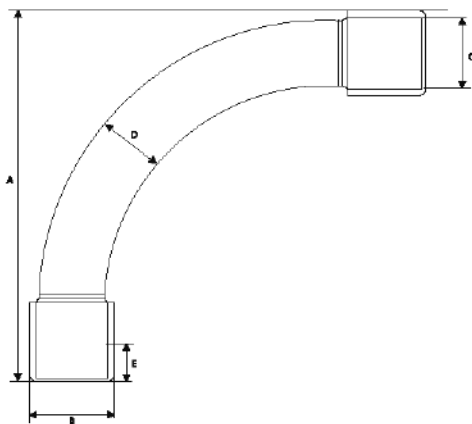

CODE	PIPE Ø	A	B	C	D	E
OL70121	16	62,5	16,2	15,9	16,0	18,0
OL70122	20	78,0	20,2	19,9	20,0	22,0
OL70123	25	97,7	25,3	24,9	25,0	27,0
OL70124	32	123,3	32,3	31,9	32,0	33,0
OL70125	40	157,7	40,4	39,9	40,0	40,0
OL70126	50	196,7	50,4	49,9	50,0	50,0

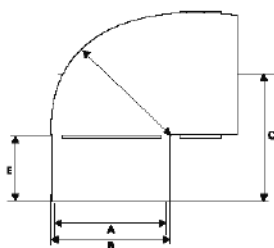

CODE	PIPE Ø	A	B	C	D	E
OL70101	16	16,2	20,2	32,5	10,5	17,1
OL70102	20	20,2	24,8	33,5	13	17,1
OL70103	25	25,2	30,8	38	17	18,2
OL70104	32	32,3	37,7	42,7	21	18,2

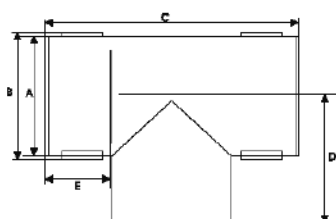

CODE	PIPE Ø	A	B	C	D	E
OL70131	16	16,2	20,1	65	32,5	17
OL70132	20	20,2	24,2	70,2	35,3	17
OL70133	25	25,2	30,8	75,2	37,6	17,5
OL70134	32	32,3	37,2	82,0	41,3	18,5

ELECTRICAL EQUIPMENT INSTALLATION / MATÉRIEL ÉLECTRIQUE D'INSTALLATION

FISHTAPES AND HOSES / CORDONS EXTENSIBLES, TIRE FILS ET OUTILS

NYLON FISH TAPES WITH FIXED RINGS AND TERMINALS
 AIGUILLE TIRE FILS EMBOUT EN LAITON

	CODE RÉFÉRENCE	LENGTH (m) LONGUEUR (m)	Ø	PACK Pcs. EMB. Pcs.
	OL 90051	5	3	70
	OL 90052	10	3	40
	OL 90053	15	3	30
	OL 90054	20	3	20
	OL 90061	5	4	50
	OL 90062	10	4	25
	OL 90063	15	4	20
	OL 90064	20	4	15
	OL 90065	25	4	12
	OL 90066	30	4	10

NYLON FISH TAPES WITH INTERCHANGEABLE EYELETS AND TERMINALS
 TIRE FILS EN NYLON AVEC TÊTES INTERCHANGEABLES LAITON

	CODE RÉFÉRENCE	LENGTH (m) LONGUEUR (m)	Ø	PACK Pcs. EMB. Pcs.
	OL 90071	5	4	50
	OL 90072	10	4	25
	OL 90073	15	4	20
	OL 90074	20	4	15
	OL 90075	25	4	12
	OL 90076	30	4	10

HIGH RESISTANCE POLYESTER FISH TAPES WITH INTERCHANGEABLE EYELETS AND TERMINALS
 TIRE FILS HAUTE RÉSISTANCE EN POLYESTER AVEC TÊTES INTERCHANGEABLES LAITON

	CODE RÉFÉRENCE	LENGTH (m) LONGUEUR (m)	Ø	PACK Pcs. EMB. Pcs.
	OL 90120	10	4	25
	OL 90121	15	4	20
	OL 90122	20	4	15
	OL 90123	25	4	12

ACCESSORIES FOR FISH TAPES THREAD M4
 ACCESSOIRES POUR TIRE FILS PAS M4

CODE RÉFÉRENCE	DESCRIPTION DESCRIPTION	BOX Pcs. COLIS Pcs.
OL 90080	Connector/Raccord	10
OL 90081	Unscrewable bullnose leader/Boucle amovible	10
OL 90082	Bullnose/Embout avec fente	10

FISH TAPES DISPLAY STAND PRÉSENTOIR POUR TIRE-FILS	
CODE RÉFÉRENCE	PACK Pcs. EMB. Pcs.
OL90999	1

SPIRAL HOSES
 GAINES FLEXIBLE

CODE RÉFÉRENCE	INNER Ø	COLOUR COULEUR	m PER ROLL m PAR ROULEAU
OL G0010	10		30
OL G0012	12		30
OL G0014	14		30
OL G0016	16		30
OL G0020	20		30
OL G0022	22		30
OL G0025	25		30
OL G0028	28		30
OL G0032	32		30
OL G0035	35		30
OL G0040	40		30
OL G0050	50		30

CORRUGATED HOSES
 GAINES ELASTIQUE

EN 61386-1 EN 61386-22			
CODE RÉFÉRENCE	Ø	COLOUR COULEUR	m PER ROLL m PAR ROULEAU
OLT11116	16		100
OLT11120	20		100
OLT11125	25		50
OLT11132	32		25
OLT11140	40		25
OLT11150	50		25
OLT10161	16		100
OLT10201	20		100
OLT10251	25		50
OLT10321	32		25
OLT10401	40		25
OLT10501	50		25
• OLT11216	16		100
• OLT11220	20		100
• OLT11225	25		50
• OLT11232	32		25
• OLT11240	40		25
• OLT11250	50		25

• with wire guide/Gaine profilée ICTA

GENERAL NOTES

GENERAL SALES CONDITIONS - SYMBOLS

- 1 - Prices and conditions only become binding at the time of acceptance of the order, by us, with written confirmation. Your purchase order is an implicit acceptance of our General Conditions of Sale.
- 2 - The conditions and other commitments entered into the quotation by us are only valid if an order is placed for everything which is included in that quotation.
- 3 - Estimates, outline designs, etc. attached to the quotation are our exclusive property and may not therefore be communicated to third parties without our written authorisation.
- 4 - Any modifications to the quotation and to these general supply conditions must be in writing and are limited to what is clearly agreed.

WEIGHTS - DIMENSIONS - TECHNICAL DATA

- 5 - Estimates, projects, drawings, photographs, colors and technical specifications listed in the catalogues, price lists and offers, are meant to be indicative and not binding for the company, which reserves the right to modify them at any time for improving product performances. For more information, please call our technical department.

PRICES

- 6 - Prices and discounts on list prices and quotations are subject to variation according to market requirements or in line with variations in the cost of raw materials or labour, without any prior notice to our Customers. Prices are EXW-Incotems 2010; transport costs, customs duties and any other types of expense are always payable by the Customer, unless otherwise agreed in writing.

PACKING AND TRANSPORT

- 7 - Packaging, which is invoiced at cost, is non-returnable. Our Company standard condition of delivery is EXW and therefore cannot be held responsible for missing or irregular deliveries by carriers, being explicitly understood that, even if the Company helps organize the shipment to the Customer's premises, the goods travel at the entire risk of the Purchaser. Any return of goods must first be authorised by our Company and goods must be returned free of any cost to our Factory warehouses.

DELIVERY TIMES

- 8 - Agreed delivery times are indicative and not legally binding and are subject to the clause "unless sold" for goods indicated as ready; they are valid only in normal working and supply conditions. Our Company shall in no circumstances or for any reason be liable to pay compensation of any kind of direct or indirect damage due to late deliveries.

PAYMENT - RETENTION OF PROPERTY TITLE

- 9 - Payment terms and conditions must be agreed in writing or, failing this, shall be understood to be net cash on delivery of the goods. The goods remain the property of Olan Ltd. and will not be transferred to the client until the same has not made full payment of the price stated in the invoice, meaning the sale under the above condition. Therefore, in case of non-payment, Olan Ltd will be entitled to claim the delivered goods even in case of bankruptcy of the buyer. In the event of late payment, the Customer undertakes to pay interest on delayed payment equivalent to the average market rate applied by Financial Institutions, plus 4%. If the purchaser fails to comply, even partially, with any of the conditions agreed for collection of the goods or for settlement and payment of individual invoices, our Company has the right to immediately suspend further deliveries and consider itself free of any contractual obligation, while retaining all its rights relating to failure to comply with the contract. Unless expressly agreed otherwise, payments must always be made directly to our Company.

CLAIMS

- 10 - Any claims relating to the supply of goods must reach us within 12 days of receipt of such goods, after which time they will no longer be accepted. Every claim must be based on concrete facts in order to be taken into consideration. We shall be entitled, at our discretion, to take back or replace goods which the Customer demonstrates to be faulty, but will not accept any costs for repairs or modifications which have been made without our authorisation. It remains understood that any claims on any single consignment of goods will have no effect on the balance of the order or the obligation, or on payment for other goods already received without complaint.

WARRANTY



- 11 - The warranty we offer for products made by us is 12 months from the date of the corresponding invoice and, during this period, we undertake to repair or replace free of charge in our workshops any parts or equipment which are unusable due to defective materials or workmanship. In all cases, we reserve the right to decide, at our entire discretion, whether repair or replacement is most appropriate. We however exclude the possibility of sending our personnel to make on-site inspections to installations where our equipment is installed, except in cases where, at our entire discretion, we believe it is necessary to check the operating conditions to which our equipment has been subjected.
- 12 - Our warranty is naturally valid provided that the Customer has used and treated our equipment with due care, that the equipment has not been misused or modified and that all the technical requirements contained in our price lists and instruction sheets have been complied with. The warranty does not cover parts which, due to the nature of the material with which they are made or to their specific use, are subject to premature wear; damage due to normal wear and tear is also excluded.
- 13 - The Customer must send written notification of failures and defects, giving an exact description of their nature and we shall arrange, within the necessary time required, repairs and replacement under the above terms and conditions. Material for repair or replacement must be delivered to us, carriage paid.
- 14 - With the repair or replacement of the equipment or any of its parts which were defective, our Company shall be relieved of all and any responsibility of any kind, while the Customer shall consider him/herself entirely satisfied by this fact and shall renounce any request for damages and costs. In certain cases, we may allow the Customer to arrange any necessary repairs or replacements, it being understood that our only obligation will be to refund any out-of-pocket expenses accepted as essential to put our equipment in working order.
- 15 - In the event of disputes of a technical nature, the parties shall submit to the opinion of an expert to be appointed by joint agreement or, if agreement cannot be reached on the appointment, selected by the President of the Milan Court.
- 16 - We shall not accept any expenses which may have been borne by the Customer, even within the warranty period, without our prior written authorisation.
- 17 - Our Company reserves the right to use, in the manufacture of its equipment, any material it deems the most suitable and to make any modifications it deems necessary to the shape, weight or dimensions of its products.

DISPUTES

- 18 - All agreements, even if entered into with foreign companies or individuals or for materials supplied abroad, shall be governed solely by current Italian law. The Milan courts shall have sole jurisdiction over any dispute which may arise in relation to the performance of the Agreement, including by way of exception to sections 31 et seq. of the Civil Procedure Code, and the Customer shall not be entitled to file proceedings before the courts of any other place, even in the case of proceedings involving a guarantee or *lis alibi pendens*, without prejudice to the supplier company's right to take proceedings, as plaintiff, in the courts of the Customer's place of residence, whether in Italy or abroad.
- 19 - Disputes do not in any way relieve the Customer from having to comply with agreed payment terms and do not imply any extension of the terms agreed.

The mark Olan, Alofree, Articon, Canalplast, CaZn, CP Box, CP Din, CZE, Desko, Dominio, Ecabl, Edge, FiloCP, Hypogeo, Lineadin, Mini System, Mini Tris, Monolyto, Simmetris 2120, Sistema Tris, Sonda CP, Sotto, Spiro, Sys45Rapid, Talpa, Tipo G, Triall, Triadra, Tris 2000 are of ownership of Canalplast S.p.A. Except our authorization, the total or partial reproduction of the present catalogue is distrusted.

SYMBOLS

	Temperature of use °C Min/Max
IP	IP Protection grades
	Complete isolation protection
PI	Breaking power

Vn	Nominal voltage
T	Grounding
IK	Mechanical protection grade

HEAT RESISTANCE	
TB	Thermocompression with ball
GWT	Glow wire test °C

NOTES GÉNÉRALES

CONDITIONS GÉNÉRALES DE VENTE - SYMBOLES

- 1 - Les prix et conditions commerciales sont acceptés dès lors de notre accusé réception de la commande par retour écrit. La commande d'achat du client implique de facto l'acceptation par celui-ci de nos conditions générales de vente.
- 2 - Les conditions et autres engagements que nous avons pris avec l'offre ne sont valables que si la commission comprend tout ce qui fait l'objet de l'offre.
- 3 - Les propositions commerciales, les devis et autres offres commerciales spécifiques appartiennent exclusivement à CANALPLAST Group et ne pourront en aucun cas être divulguées à des tiers sans autorisation écrite de notre part.
- 4 - Toute modification de l'offre et des présentes conditions générales de ventes, doit être indiquée par écrit et limitée à ce qui a été expressément convenu.

POIDS - DIMENSIONS - DONNEES TECHNIQUES

- 5 - Les devis, projets, dessins, photos, couleurs et données techniques indiqués dans les catalogues, listes et offres sont fournis à titre indicatif et ne sont pas contractuelles pour l'entreprise, laquelle se réserve le droit de les changer à tout moment pour une meilleure précision produit. Pour toutes autres informations, veuillez contacter notre service technique

PRIX

- 6 - Les prix et remises appliqués sur les catalogues et les offres peuvent subir des variations sans aucun préavis selon les exigences du marché ou en cas de variations du coût des matières premières ou de la main d'oeuvre. Ceux-ci sont franco notre Etablissement (EXW-Incoterms 2010), les frais de transport, de douane, et droits de tout genre sont toujours à la charge du client, sauf tout autre accord écrit de notre part.

EMBALLAGE ET TRANSPORT

- 7 - L'emballage, facturé au prix de revient, n'est pas accepté en retour. La condition de retour à notre société s'entend EXW. Par conséquent, elle ne pourra pas être tenue pour responsable en cas d'absence lors de la livraison ou de livraisons irrégulières de la part des transporteurs; restant explicitement entendu que, même si la société contribue à l'organisation de l'expédition à l'adresse du client, les marchandises retourneront toujours aux risques du client. Les éventuels retours de marchandise devront être préalablement autorisés par notre Société et dépourvus de tous frais dans les entrepôts de notre Etablissement.

DELAIS DE LIVRAISON



- 8 - Les délais de livraisons prévus sont donnés à titre indicatif et ne nous engage en aucun cas légalement. Ils ne sont valables que dans des conditions de travail et d'approvisionnement normales. En aucun cas notre société ne sera obligée de verser des dommages et intérêts en cas de dommages directs ou indirects causés par des retards de livraison.

PAIEMENTS - CLAUSE DE RESERVE DE PROPRIETE

- 9 - Les conditions commerciales et les modalités de paiement doivent résulter d'un accord écrit ou, à défaut, le paiement devra être effectué en espèce à la livraison. Canalplast S.p.A. restera propriétaire de la marchandise tant que le client n'aura pas entièrement payé le prix indiqué sur la facture, la vente ayant été conclue à la condition indiquée ci-dessus. Par conséquent, en cas de non paiement, Canalplast S.p.A. aura le droit de revendiquer la marchandise livrée même en cas de faillite du client. En cas de retards de paiement, le Client s'engage à verser l'intérêt moratoire correspondant au taux moyen du marché appliqué par les Etablissements Financiers, majoré de 4%. Si l'acquéreur ne respecte pas, même partiellement, une des conditions prévues pour le retrait de la marchandise ou pour le règlement et le paiement des factures, notre Société aura le droit d'interrompre immédiatement toutes autres livraisons et se considérera exonérée de toute obligation contractuelle, restant entendu son droit éventuel en cas de non respect des clauses du contrat. Sauf tout autre accord explicite les paiements doivent toujours être effectués directement à notre Société.

Les marques Olan, Alofree, Articon, Canalplast, CaZn, CP Box, CP Din, CZE, Desko, Dominio, Ecabl, Edge, FiloCP, Hypogeo, Lineadin, Mini System, Mini Tris, Monolyto, Simmetris 2120, Sistema Tris, Sonda CP, Sotto, Spiro, Sys45Rapid, Talpa, Tipo G, Triall, Triedra, Tris 2000 appartiennent à Canalplast S.p.A. Sauf notre autorisation, la reproduction totale ou partielle du présent catalogue est interdite.

SYMBOLES

	Temperature d'utilisation C° Min/Max
IP	Degré de protection IP
	Protection d'isolement complet
PI	Pouvoir de coupure

Vn	Tension nominale
T	Mise à la terre
IK	Degré de protection mécanique

RÉSISTANCE À LA CHALEUR	
TB	Thermocompression avec balle
GWT	Glow wire test °C

RECLAMATIONS

- 10 - Les éventuelles réclamations sur les marchandises fournies devront être transmises dans un délai de 12 jours à réception de la marchandise. Une fois ce délai écoulé elles ne seront plus acceptées. Chaque réclamation devra s'appuyer sur des faits concrets pour pouvoir être prise en compte. Nous pourrions à notre appréciation reprendre ou remplacer l'article présenté comme défectueux par le client, mais nous ne reconnaitrons aucun frais engagé pour des réparations ou des changements apportés sans notre autorisation. Les éventuelles contestations sur chaque expédition de marchandise n'auront aucun effet ni sur le reste de la commande ou de l'engagement, ni sur le paiement d'une autre marchandise déjà reçue et non contestée.

GARANTIES

- 11 - La garantie que nous appliquons sur nos produits a une durée de 12 mois à compter de la date de chaque facture, c'est-à-dire qu'au cours de cette période nous nous engageons à réparer ou à remplacer gratuitement dans notre atelier les pièces ou les appareils devenus inutilisables en raison d'un défaut de fabrication ou du matériel. Dans tous les cas, nous nous réservons le droit de décider s'il est plus convenable d'effectuer la réparation ou le remplacement du produit. Nous excluons cependant l'envoi d'un de nos techniciens pour contrôler les installations sur lesquelles nos appareils ont été appliqués, sauf pour les cas où, selon notre jugement exclusif, nous estimons nécessaire de contrôler les conditions d'utilisation de nos appareils.
- 12 - Naturellement, notre garantie n'est valable que si les appareils ont été posés et traités conformément aux instructions, s'ils n'ont pas été altérés ou modifiés et si toutes les normes techniques ont été respectées. La garantie n'est pas valable pour les pièces sujettes à une usure prématurée en raison de la nature du matériel dont elles sont composées ou de leur emploi spécifique. De même, les pannes dérivant d'une usure naturelle sont également exclues de la garantie.
- 13 - Le client devra communiquer par écrit toutes les pannes et tous les défauts relevés en indiquant exactement leur nature, et nous interviendront, dans les meilleurs délais, à la réparation et remplacement selon les circonstances et dans les délais indiqués ci-dessus. Le matériel à réparer ou à remplacer devra nous être retourné en port payé.
- 14 - En cas de réparation ou de remplacement des appareils ou des pièces défectueuses, notre Société est exonérée de toute responsabilité à quel que titre que ce soit, et le client est de part ce fait entièrement désintéressé et renonce à toute demande de dommages et intérêts et de remboursement de frais. Dans certains cas nous pouvons autoriser le client à pourvoir aux éventuelles réparations ou remplacements, restant entendue la seule obligation de notre part de rembourser les charges directes considérées indispensables pour la remise en état de nos appareils.
- 15 - En cas de divergences sur des aspects techniques, les parties feront appel à un expert nommé d'un commun accord ou, en cas de divergence sur cette nomination, choisi par le Président du Tribunal de Milan.
- 16 - Nous ne reconnaitrons aucune dépense éventuellement engagée par l'Acquéreur, même pendant la période de garantie, sans notre autorisation écrite préalable.
- 17 - Notre Société se réserve le droit d'employer dans la fabrication de ses appareils tous matériaux qu'elle estime les plus adaptés et d'apporter toutes les modifications dans la forme, le poids ou les dimensions de ses produits qu'elle estime les plus appropriées.

LITIGES

- 18 - Les contrats, même s'ils sont stipulés avec des Sociétés et des citoyens étrangers ou pour des matériels fournis à l'étranger, sont réglés exclusivement par la législation italienne en vigueur. En cas de litige concernant l'exécution du contrat, la juridiction compétente sera exclusivement le Tribunal de Milan, même en dérogation des articles 31 et suivants du Code de Procédure Civile, en excluant la possibilité pour le Commettant de saisir l'Autorité Judiciaire d'un autre lieu, y compris comme garantie ou connexité, mais sauf le droit pour le fournisseur d'intenter, en qualité de demandeur, une action sur le lieu de résidence, en Italie ou à l'étranger, du Commettant.
- 19 - Les éventuelles contestations ne dispensent absolument pas le Commettant d'observer les conditions de paiement et n'impliquent aucun prolongement des délais.

CANALPLAST

Canalplast S.p.A.

Via Tolstoj, 65 - 20812 Limbiate (MB) Italy
Phone +39 02990642.1 - Fax + 39 0299055900
www.canalplast.it - www.canalplast.eu
e-mail: export@canalplast.it

OLAN

Olan Srl

Via Marconi, 39 - 20812 Limbiate (MB) Italy
Phone +39 0299055317 - Fax +39 0299488724
www.olansrl.com
e-mail: export@olansrl.com